



US00D588412S

(12) **United States Design Patent**
Brooks

(10) **Patent No.:** **US D588,412 S**
(45) **Date of Patent:** **** Mar. 17, 2009**

(54) **MUG**

D558,523 S * 1/2008 Bhavnani D7/510
D569,188 S * 5/2008 Tomqvist D7/523

(76) Inventor: **Sammi Brooks**, 475 E. Duarte Rd.,
Monrovia, CA (US) 91016

(**) Term: **14 Years**

* cited by examiner

(21) Appl. No.: **29/292,307**

Primary Examiner—Antoine D Davis

(22) Filed: **Oct. 6, 2007**

(74) *Attorney, Agent, or Firm*—Clement Cheng

(51) **LOC (9) Cl.** **07-01**

(57) **CLAIM**

(52) **U.S. Cl.** **D7/510**

The ornamental design for a mug, as shown and described.

(58) **Field of Classification Search** D7/213,
D7/300–305, 505–509, 589, 592, 320, 321,
D7/312, 510, 511, 533, 532, 514, 543–548,
D7/534–538, 598, 600, 318, 605, 2, 3, 9,
D7/38, 52, 58, 81, 550.1, 553.1, 553.5, 554.3,
D7/554.4, 619.1, 630; D9/737, 738, 741,
D9/744, 551, 671; D3/202, 30.1, 99, 36;
99/317, 323, 323.3, 285, 321; 100/123; 126/348;
206/217, 541, 150, 501, 45; 211/71, 49.1,
211/53, 74, 77, 78, 79; 215/388, 227–354;
220/592.16, 592.17, 592.2, 592.21, 703–716,
220/735, 28, 23.83, 756, 769, 771, 23.4,
220/23.86; 222/130, 189.07, 108, 500, 129;
248/311.2

DESCRIPTION

See application file for complete search history.

FIG. 1 is a perspective view.

FIG. 2 is a front perspective view.

FIG. 3 is a rear side perspective view.

FIG. 4 is a left side perspective view.

FIG. 5 is a right side perspective view.

FIG. 6 is a top view; and,

FIG. 7 is a bottom view.

The broken line showing of the lid is included for the purpose of illustrating non-claimed subject matter and forms no part of the claimed design.

(56) **References Cited**

U.S. PATENT DOCUMENTS

D528,861 S * 9/2006 Herrera D7/510

1 Claim, 6 Drawing Sheets

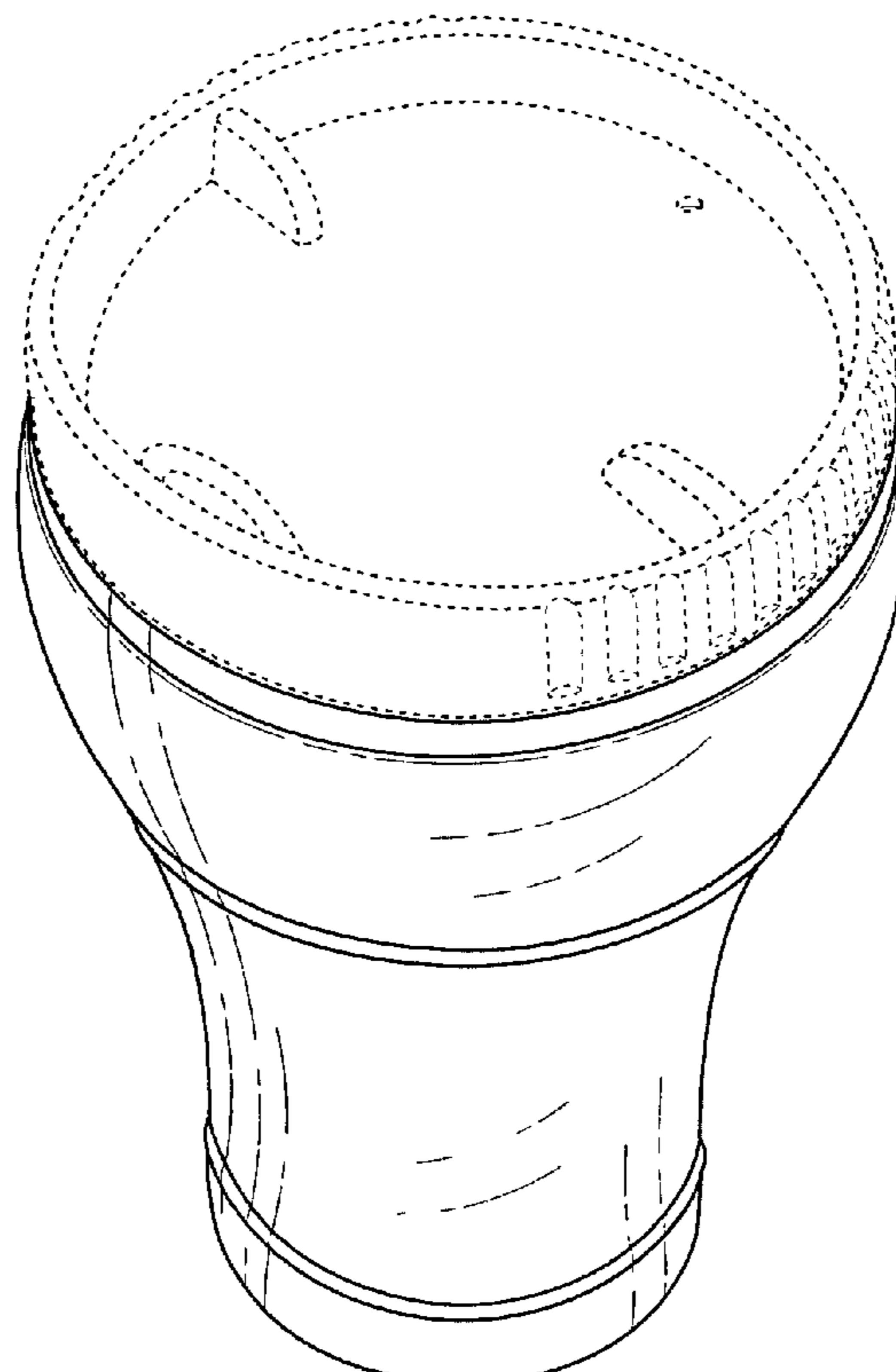

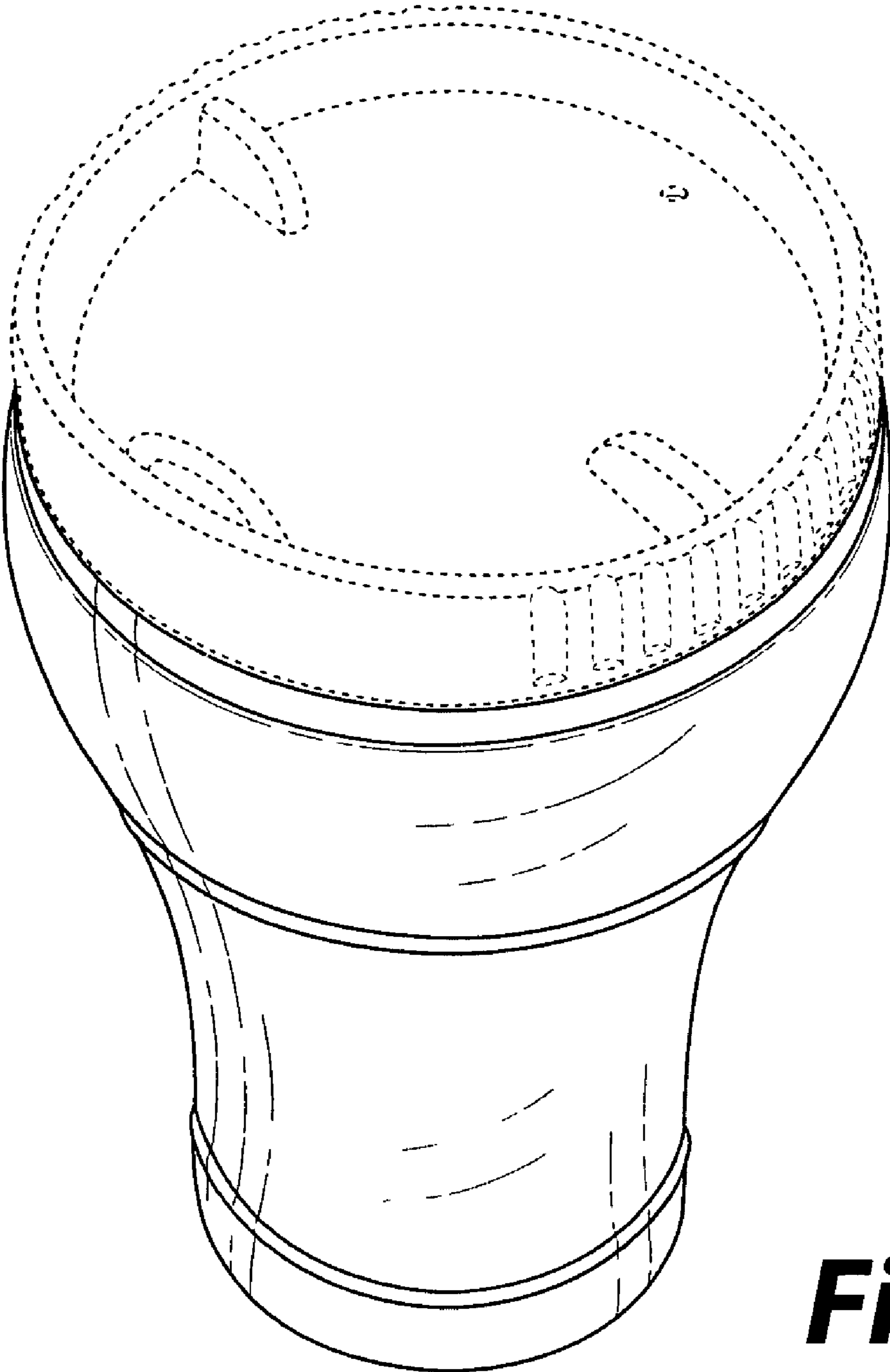

Fig. 1

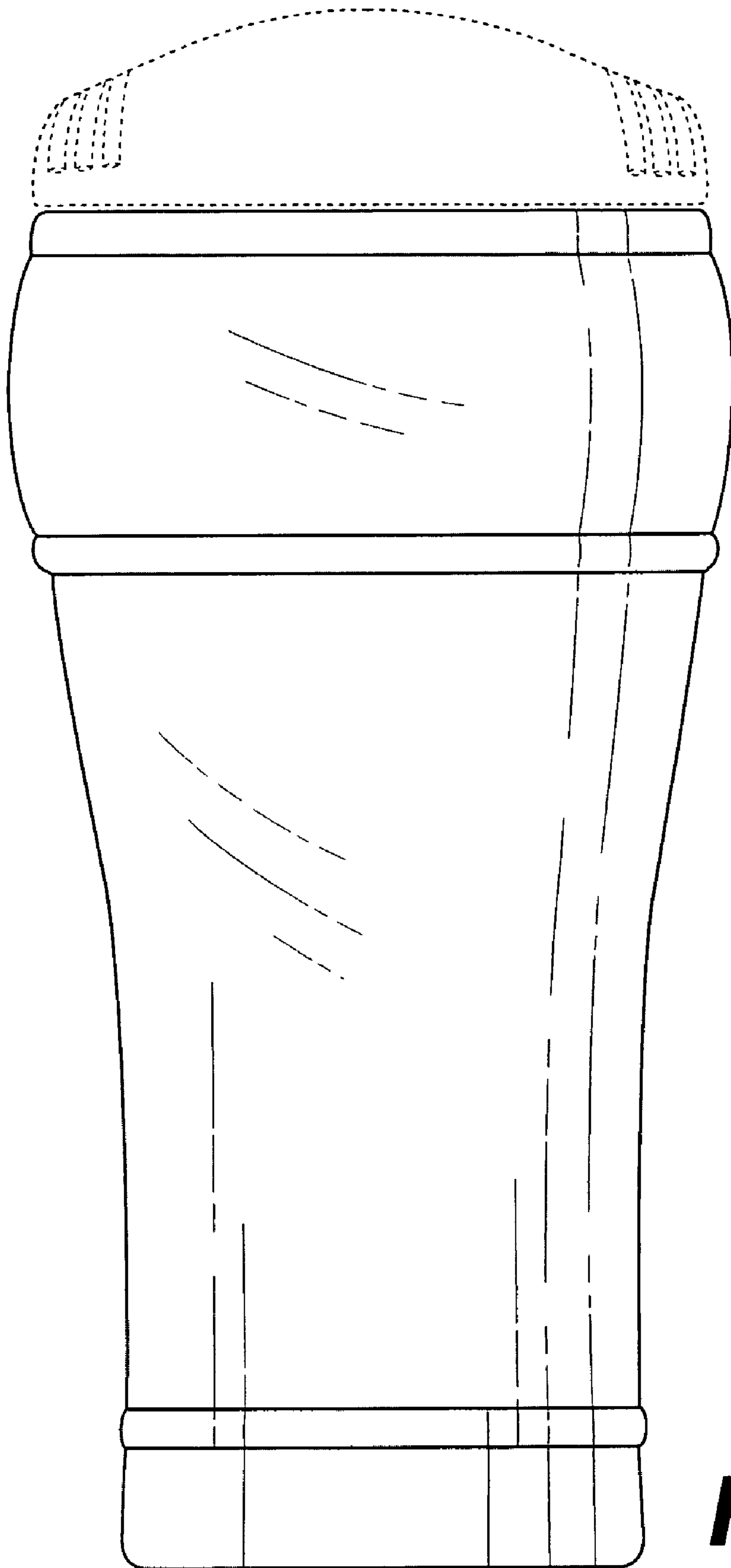

Fig.2

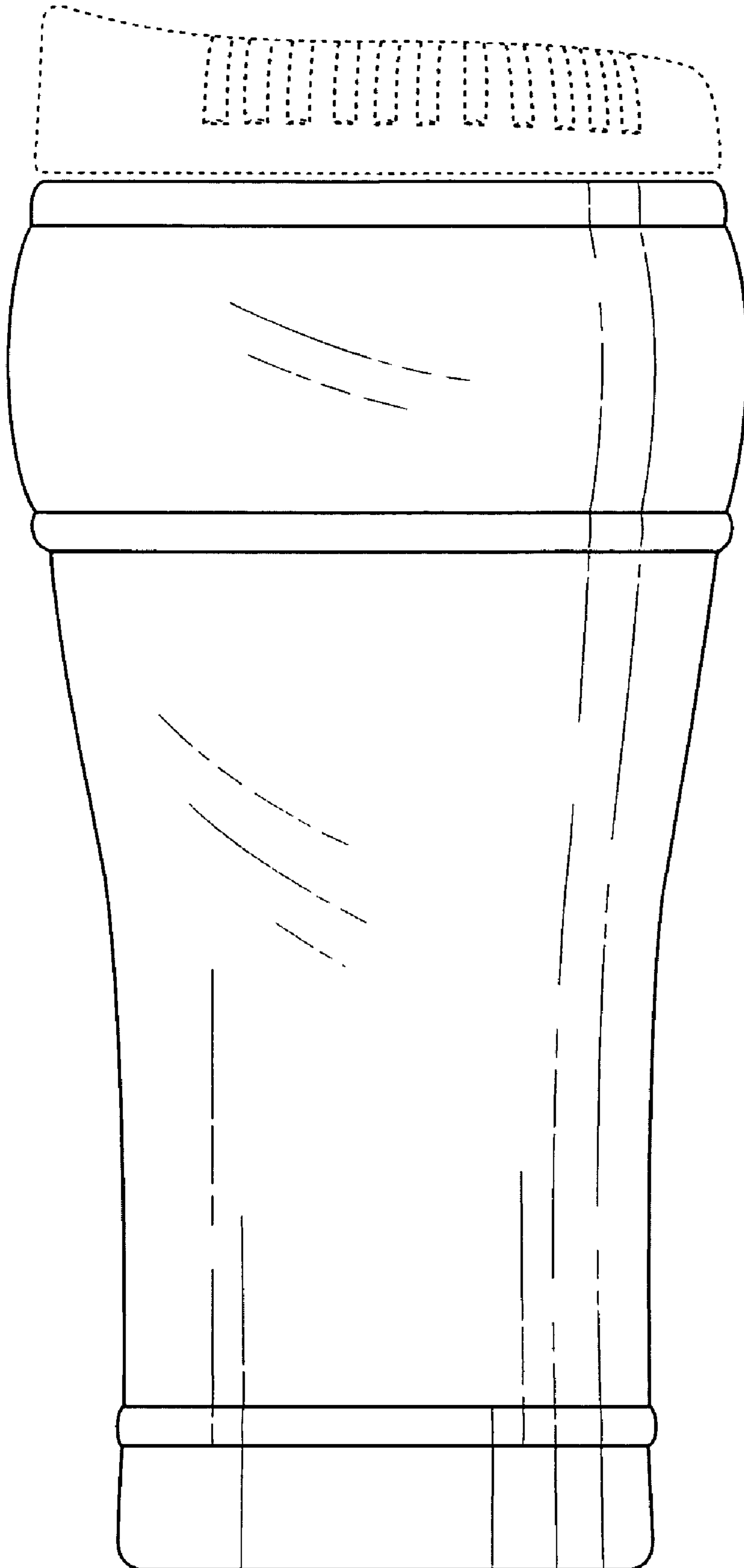

Fig.3

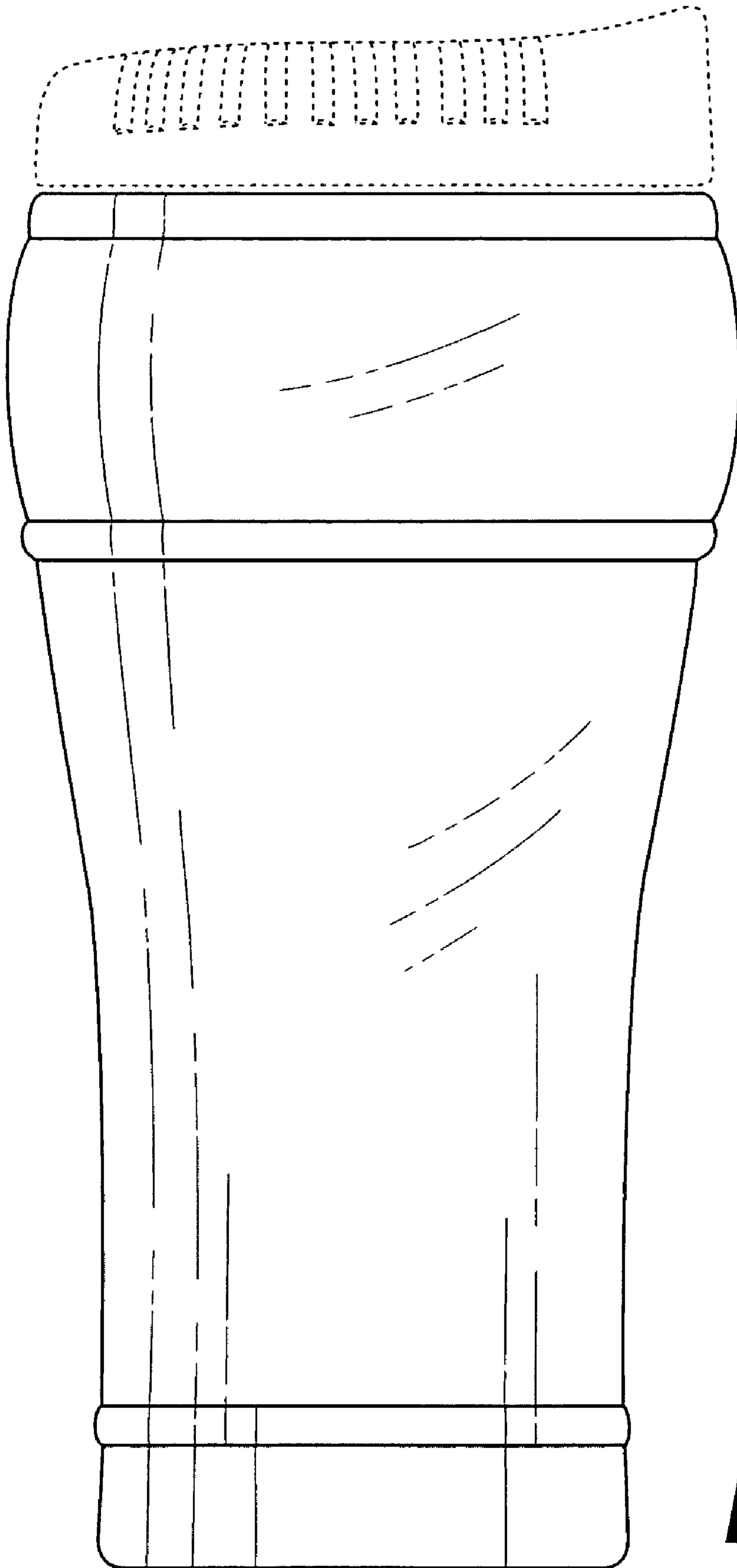

Fig.4

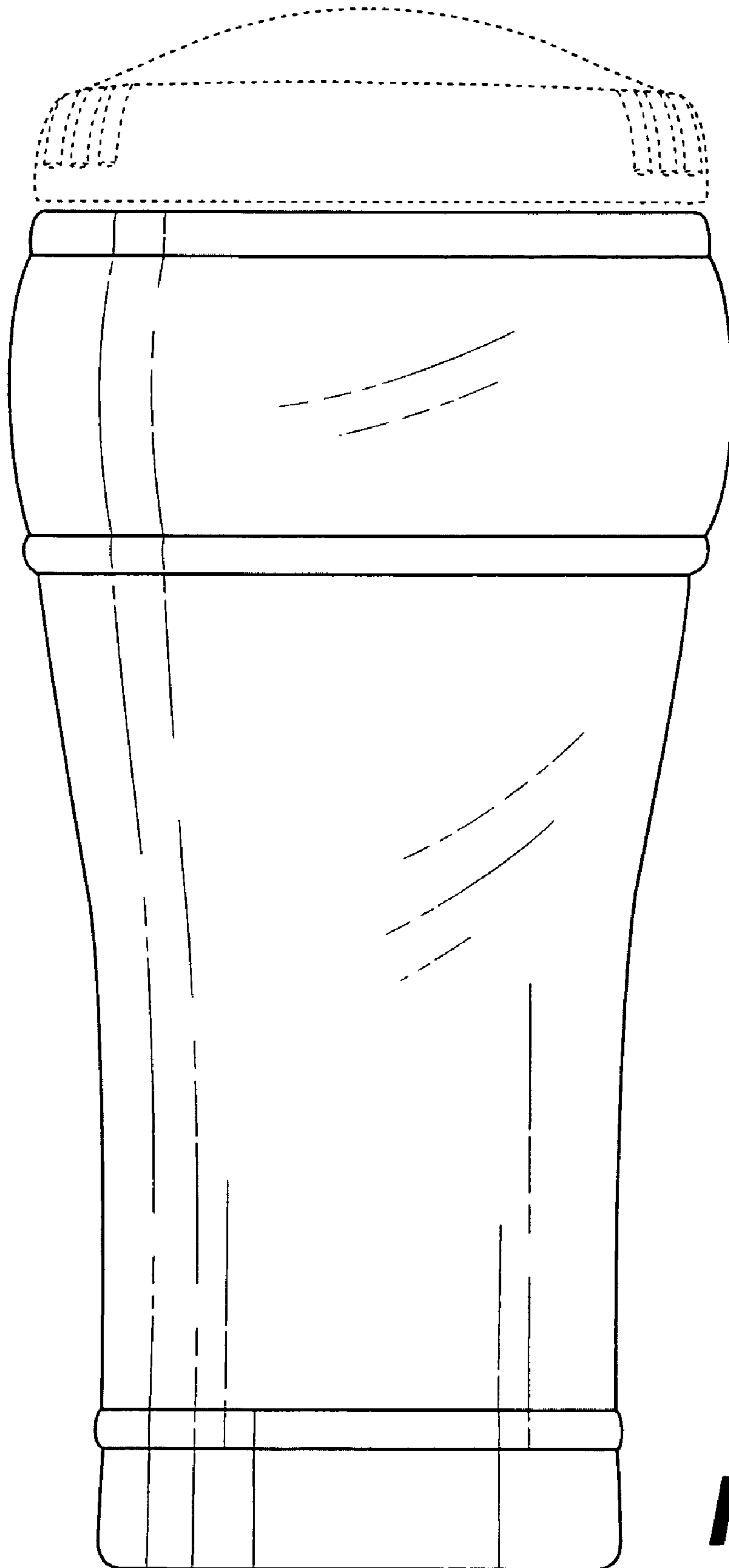

Fig. 5

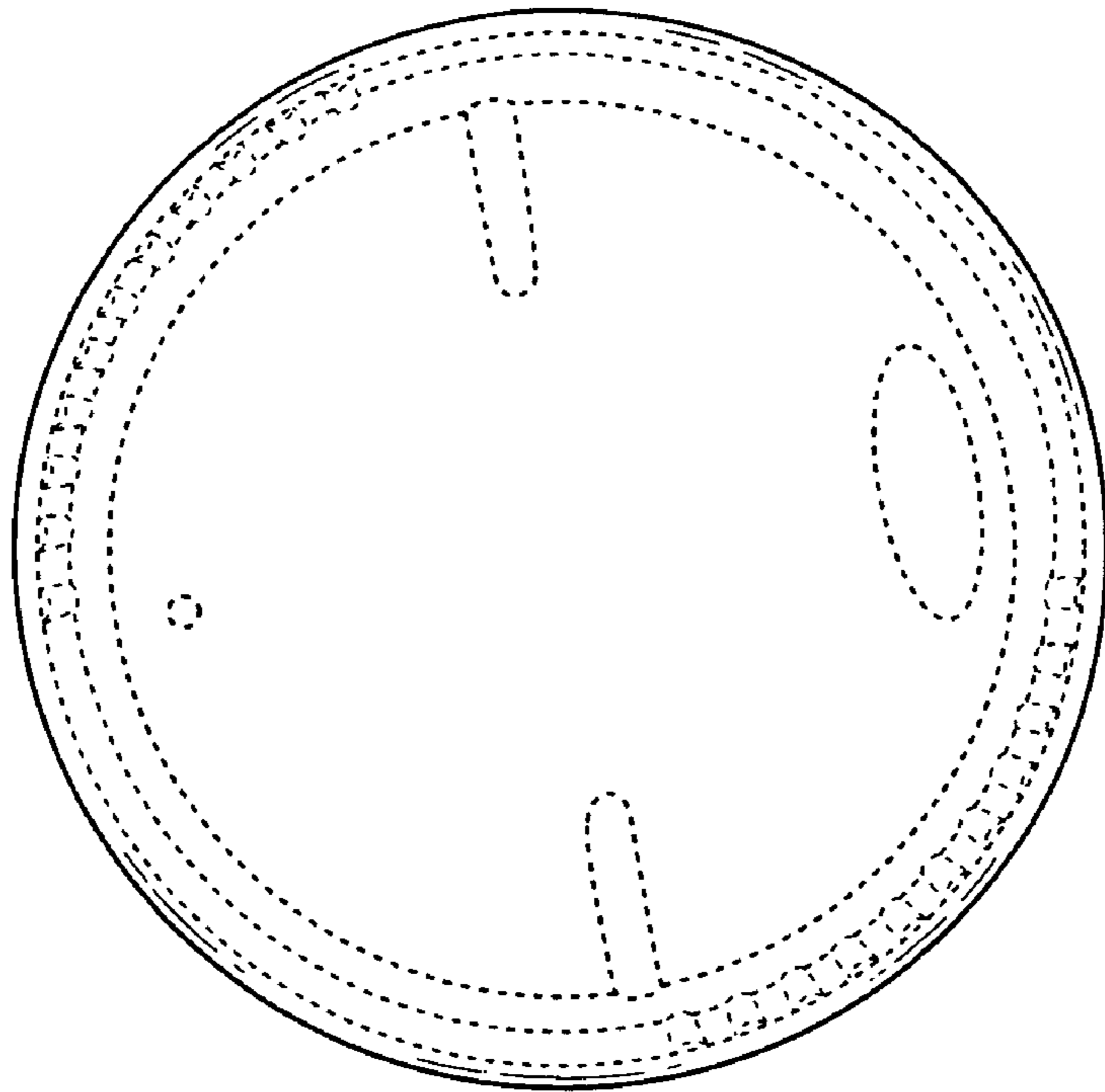

Fig.6

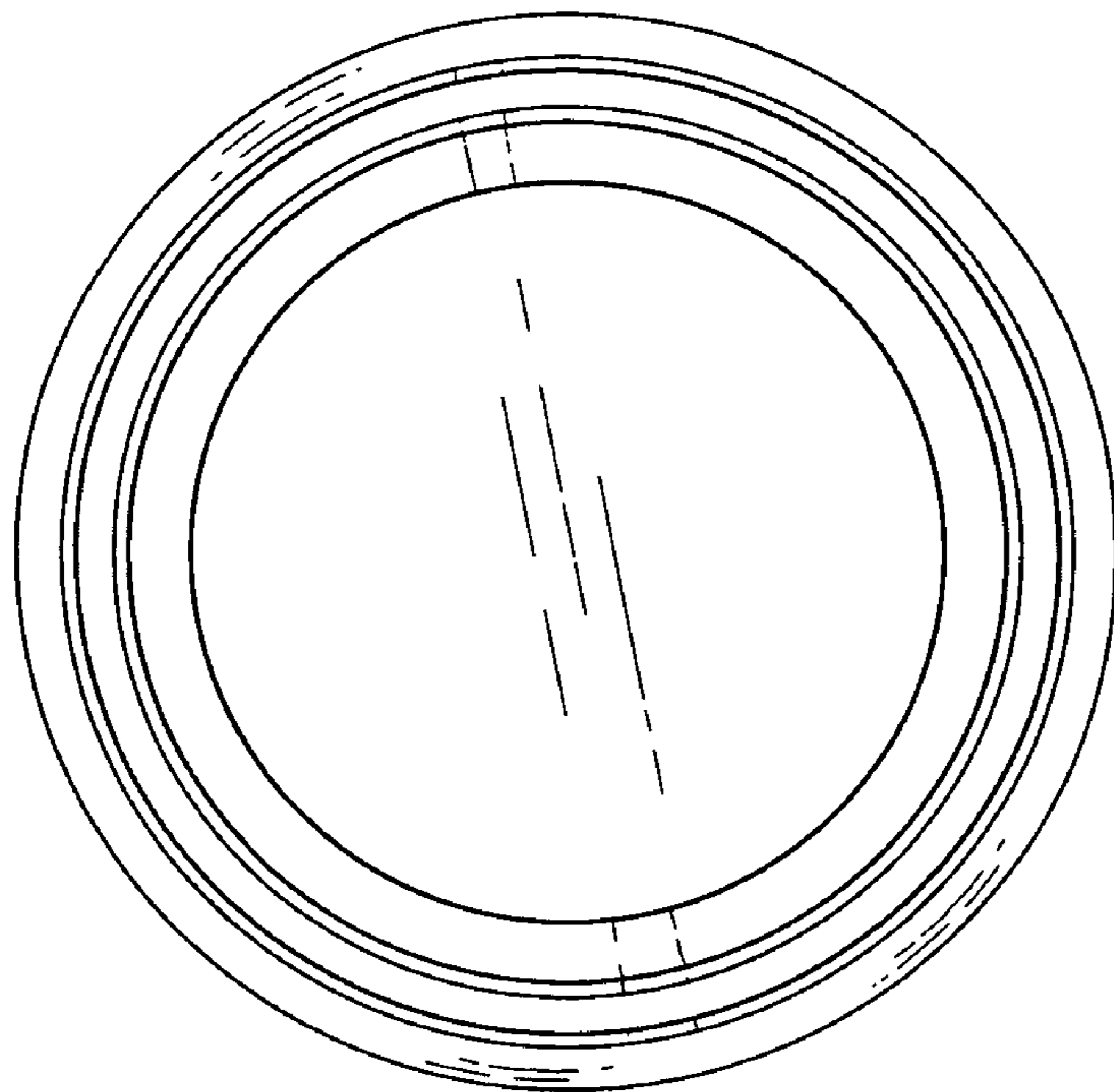

Fig.7