



US00D588399S

(12) **United States Design Patent**  
**Vrbanek**

(10) **Patent No.:** **US D588,399 S**  
(45) **Date of Patent:** **\*\* Mar. 17, 2009**

(54) **HEALTHY BARBEQUE GRILL**

(76) Inventor: **Drago Vrbanek**, 4257 Capilano Court,  
Mississauga, Ontario (CA) L4W 4H9

(\*\*) Term: **14 Years**

(21) Appl. No.: **29/294,421**

(22) Filed: **Jan. 11, 2008**

(30) **Foreign Application Priority Data**

Oct. 19, 2007 (CA) ..... 122761

(51) **LOC (9) Cl.** ..... **07-02**

(52) **U.S. Cl.** ..... **D7/359**

(58) **Field of Classification Search** ..... D3/307;  
D7/323, 354-363, 409, 505, 549; 99/425-426,  
99/444-447; 126/332, 337 R; 220/573.1-573.3  
See application file for complete search history.

(56) **References Cited**

**U.S. PATENT DOCUMENTS**

D187,237 S *	2/1960	Kindelberger	.....	D7/549
4,108,142 A	8/1978	Barson et al.		
D271,072 S *	10/1983	Mjelde	.....	D7/505
D286,494 S	11/1986	Lastuck		
4,930,491 A *	6/1990	Purello	.....	126/332
D339,264 S	9/1993	Lee		
D365,495 S *	12/1995	O'Higgins	.....	D7/359
D380,342 S *	7/1997	Edmonds	.....	D7/363
5,678,531 A	10/1997	Byers et al.		
D395,548 S *	6/1998	Morissette	.....	D3/307
5,839,361 A	11/1998	Richter		
D416,167 S *	11/1999	Barker	.....	D7/363
D424,367 S *	5/2000	Choi	.....	D7/363

D432,855 S	10/2000	Cho et al.		
D441,250 S *	5/2001	Choi	.....	D7/362
D452,630 S *	1/2002	Choi	.....	D7/362
6,389,961 B1	5/2002	Wu		
D463,202 S *	9/2002	Smith	.....	D7/359
6,446,544 B1	9/2002	Creighton		
D498,387 S	11/2004	Hojnoski		
6,844,529 B2	1/2005	Grohs		

\* cited by examiner

*Primary Examiner*—Caron D. Veynar  
*Assistant Examiner*—Ricky Pham

(57) **CLAIM**

The ornamental design for a healthy barbeque grill, as shown.

**DESCRIPTION**

FIG. 1 is a front top perspective view of a healthy barbeque grill;  
 FIG. 2 is a top plan view of the healthy barbeque grill of FIG. 1;  
 FIG. 3 is a bottom plan view of the healthy barbeque grill of FIG. 1;  
 FIG. 4 is a front elevational view of the healthy barbeque grill of FIG. 1;  
 FIG. 5 is a rear elevational view of the healthy barbeque grill of FIG. 1;  
 FIG. 6 is a right side elevational view of the healthy barbeque grill of FIG. 1; and,  
 FIG. 7 is a left side elevational view of the healthy barbeque grill of FIG. 1.

**1 Claim, 7 Drawing Sheets**

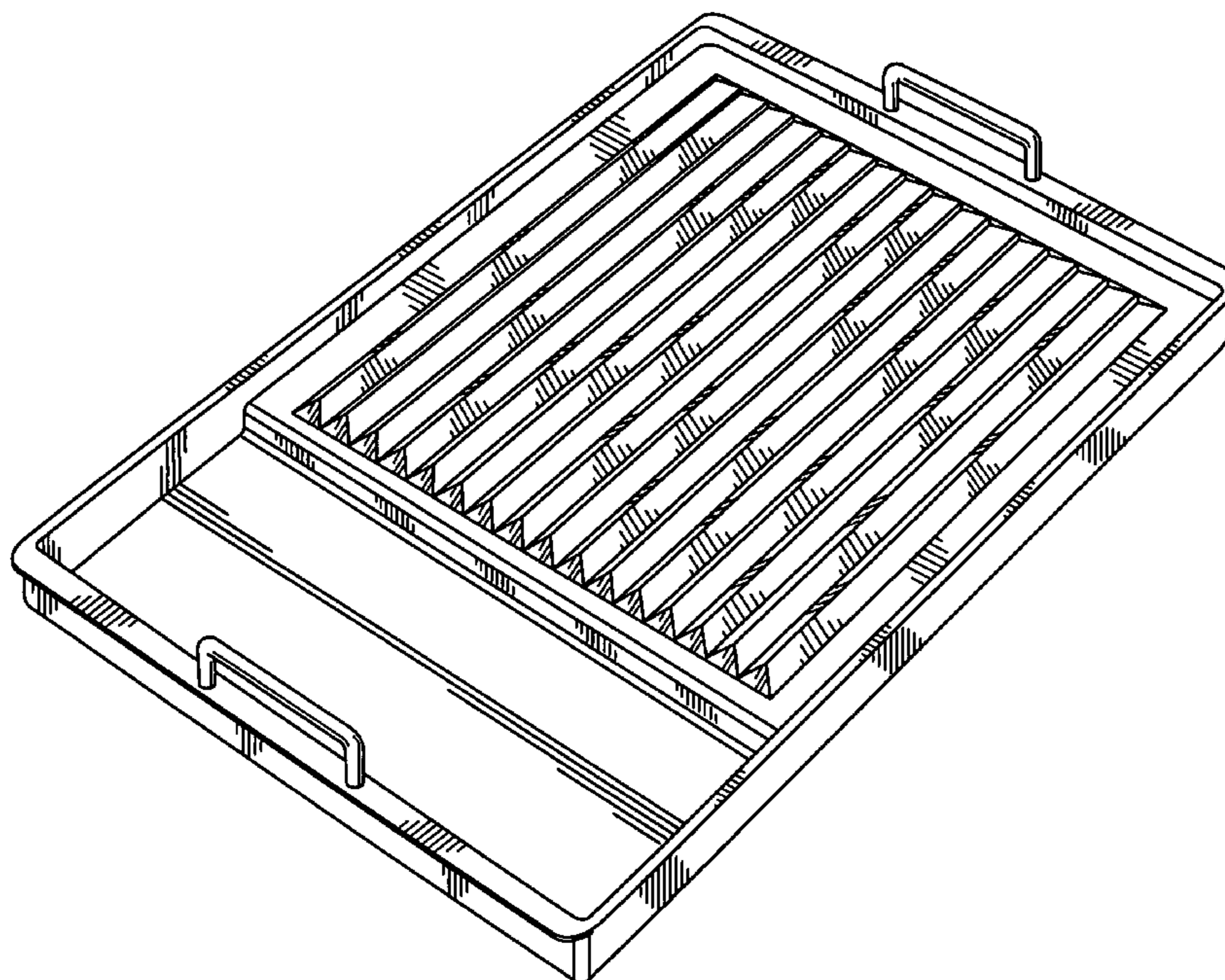

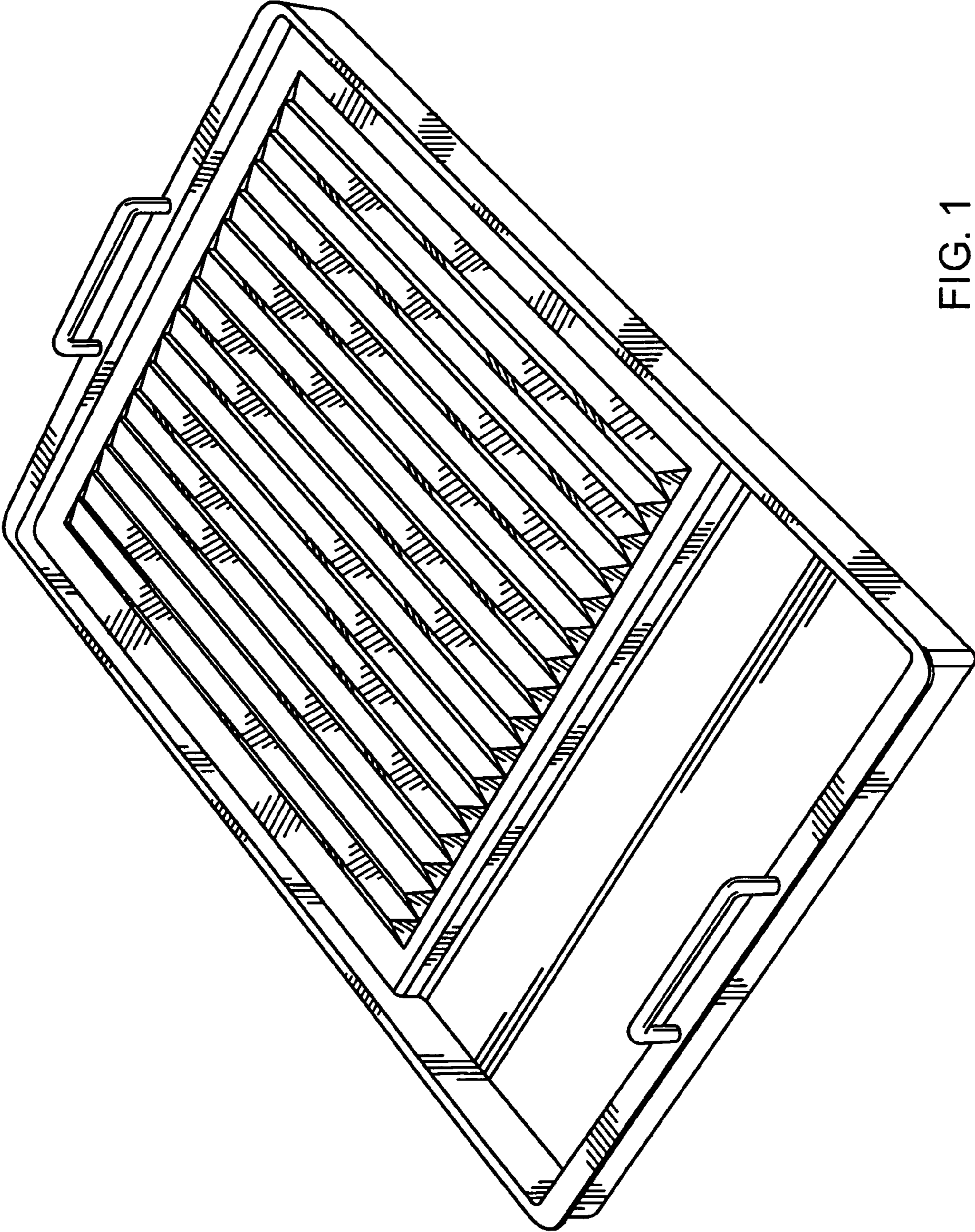

FIG. 1

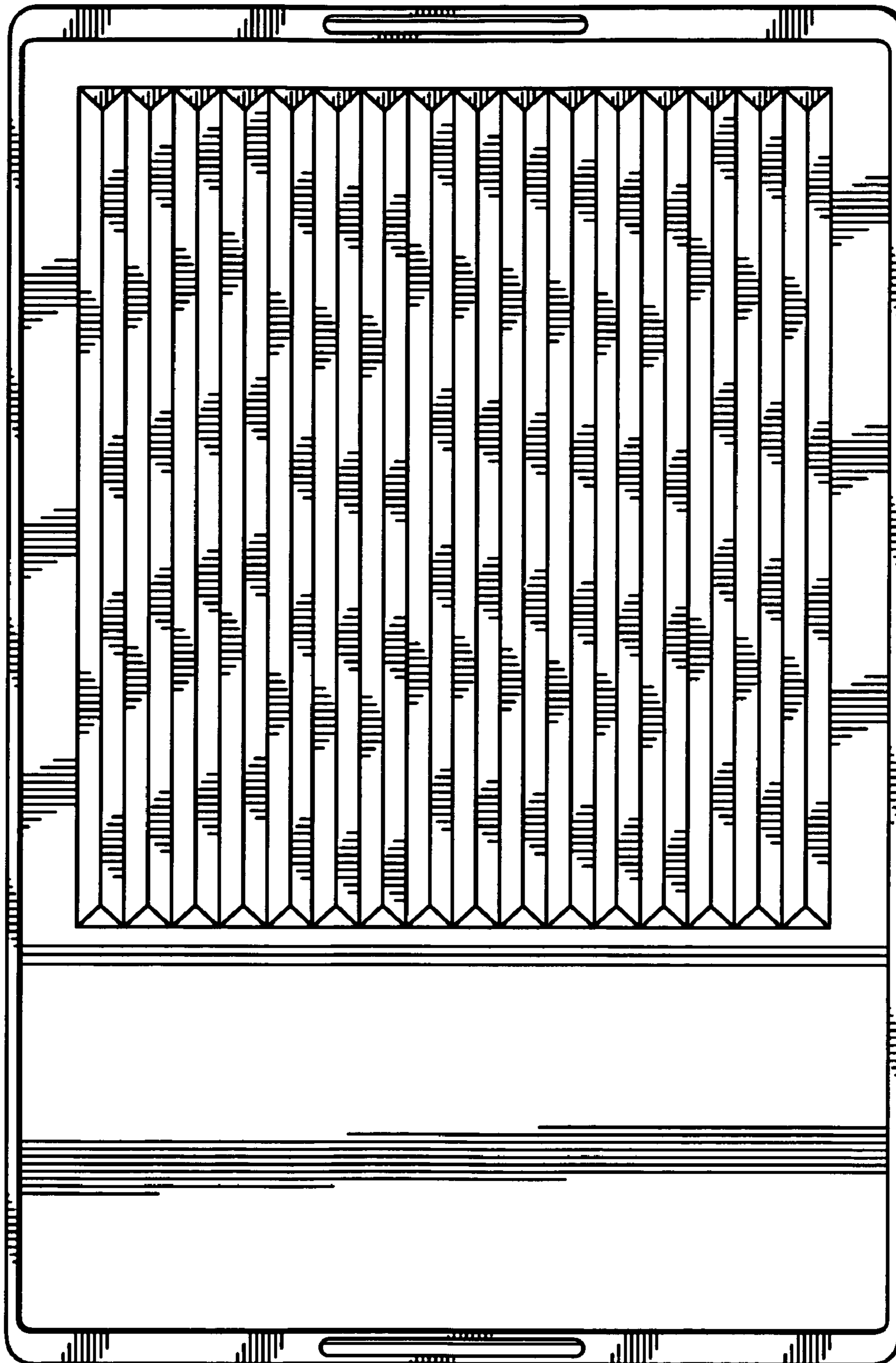

FIG. 2

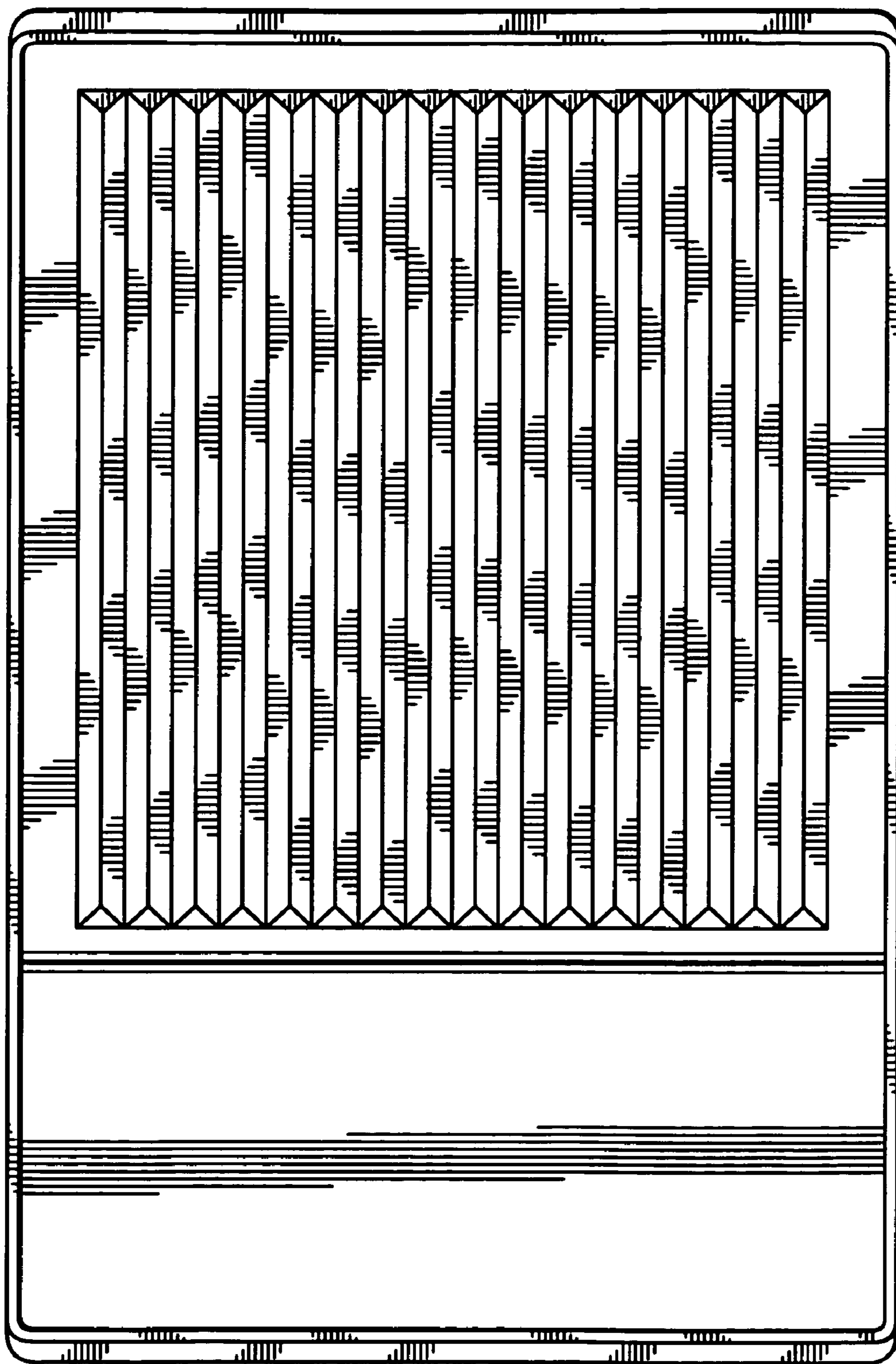

FIG. 3

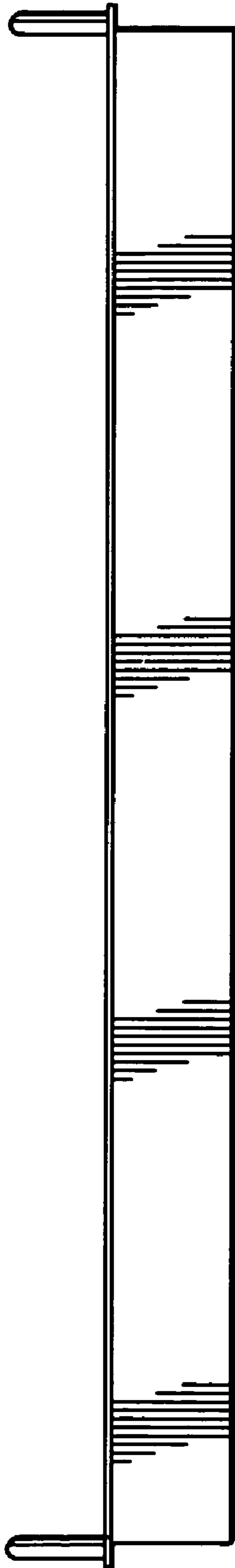

FIG. 4

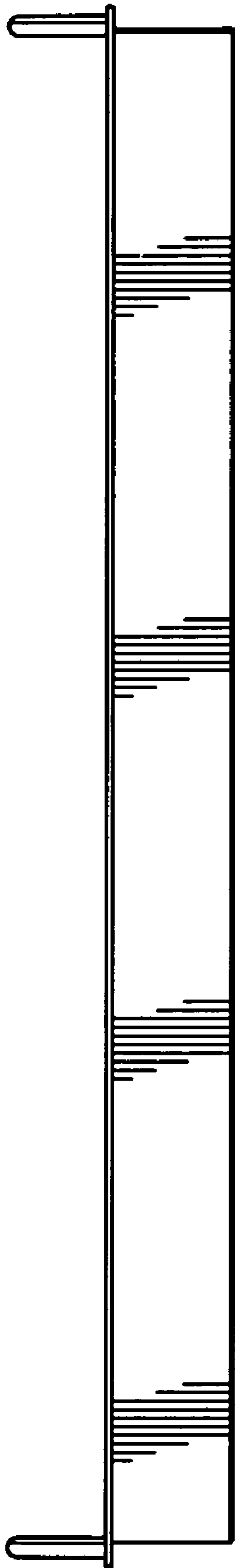

FIG. 5

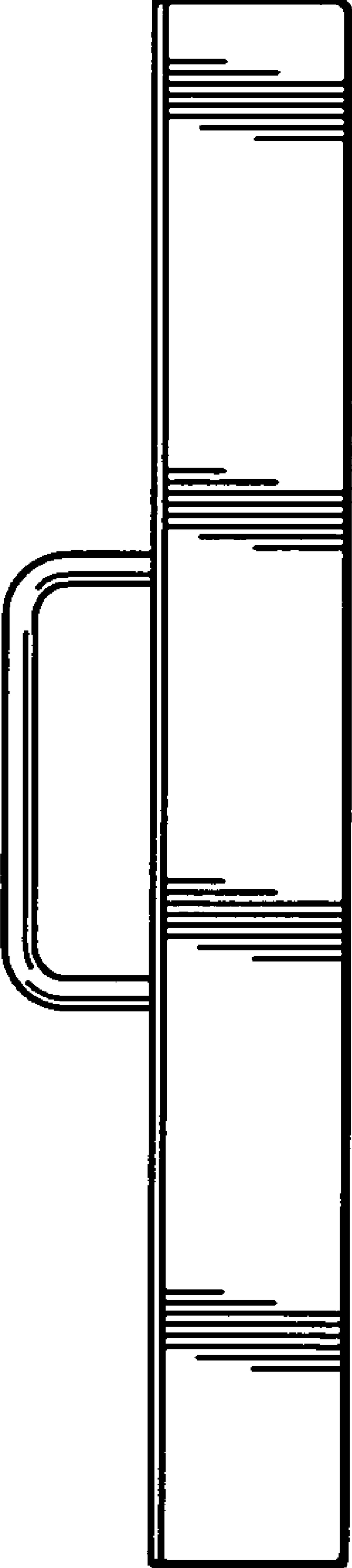

FIG. 6

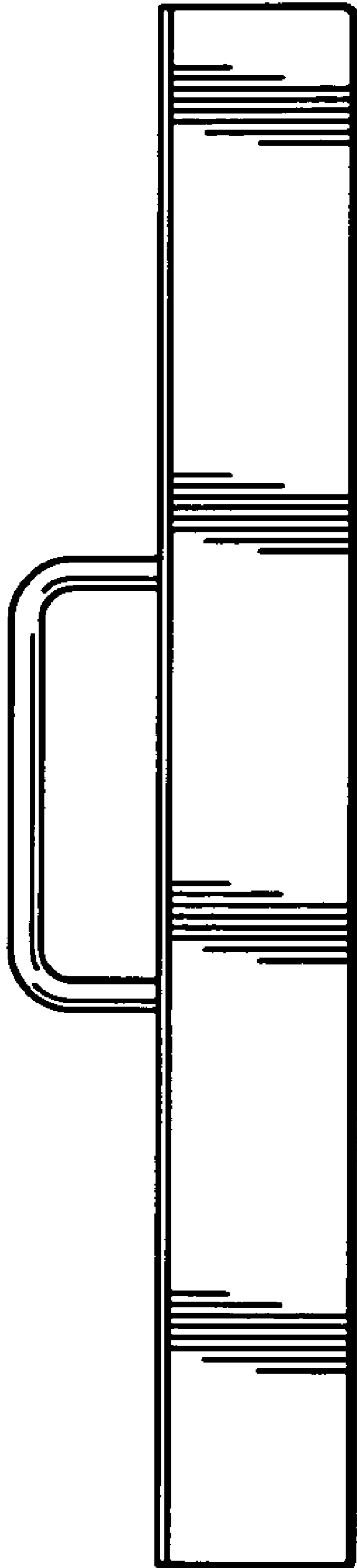

FIG. 7