



US00D588368S

(12) **United States Design Patent**
McCoy et al.

(10) **Patent No.:** **US D588,368 S**

(45) **Date of Patent:** **** Mar. 17, 2009**

(54) **LOW ROCKING CHAIR**

(75) Inventors: **Ryan McCoy**, Flacon Heights, MN
(US); **Stacy Abel**, Maple Grove, MN
(US)

(73) Assignee: **Target Brands, Inc.**, Minneapolis, MN
(US)

(**) Term: **14 Years**

(21) Appl. No.: **29/282,609**

(22) Filed: **Jul. 25, 2007**

(51) **LOC (9) Cl.** **06-01**

(52) **U.S. Cl.** **D6/344**

(58) **Field of Classification Search** D6/344,
D6/348, 374, 375, 334, 335; 297/258.1,
297/270.3, 271.5, 271.6, 272.2, 239; D21/686-687,
D21/662, 690, 695, 678, 803
See application file for complete search history.

(56) **References Cited**

U.S. PATENT DOCUMENTS

D142,800 S	*	11/1945	Watson	D6/375
3,893,731 A	*	7/1975	Maggs	297/452.17
4,027,888 A		6/1977	Wilcox	297/284
4,109,960 A	*	8/1978	Stinchfield	297/271.5
4,171,549 A		10/1979	Morrell et al.	5/465
4,258,952 A		3/1981	Dutra	297/258
D264,360 S	*	5/1982	Orenstein	D21/415
D274,576 S	*	7/1984	Tiffany	D6/335
4,875,732 A		10/1989	Miller	297/181
4,902,003 A		2/1990	Buoni	272/93
D315,643 S	*	3/1991	Wade Guy	D6/334
5,213,394 A		5/1993	Tattrie	297/258
5,419,613 A		5/1995	Wedeking	297/217.1
D360,665 S	*	7/1995	Hatfield	D21/688
D374,695 S	*	10/1996	Hatfield	D21/688
5,836,653 A		11/1998	Albecker	297/452.31
D405,971 S		2/1999	Grimsrud	D6/375

D422,800 S	4/2000	Lau	D6/348
6,155,647 A	12/2000	Albecker, III	397/452.16
D446,951 S	8/2001	Sheedy	D6/335
6,270,155 B1	8/2001	Rashid	297/1
D462,537 S	9/2002	Werner	D6/375

(Continued)

Primary Examiner—Caron Veynar

Assistant Examiner—Abraham Bahta

(74) *Attorney, Agent, or Firm*—Westman, Champlin & Kelly,
P.A.; Theodore M. Magee

(57) **CLAIM**

The ornamental design for a low rocking chair, as shown.

DESCRIPTION

FIG. 1 is a top left front perspective view of the low rocking chair showing our new design;

FIG. 2 is a left side view thereof;

FIG. 3 is a right side view thereof;

FIG. 4 is a front view thereof;

FIG. 5 is a rear view thereof;

FIG. 6 is a top view thereof;

FIG. 7 is a bottom view thereof;

FIG. 8 is a top left back perspective view of the low rocking chair in a folded state;

FIG. 9 is a right side view thereof;

FIG. 10 is a left side view thereof;

FIG. 11 is a front view thereof;

FIG. 12 is a back view thereof;

FIG. 13 is a top view thereof; and,

FIG. 14 is a bottom view thereof.

The dotted lines in the figures do not form any part of the claimed design for the low rocking chair.

1 Claim, 8 Drawing Sheets

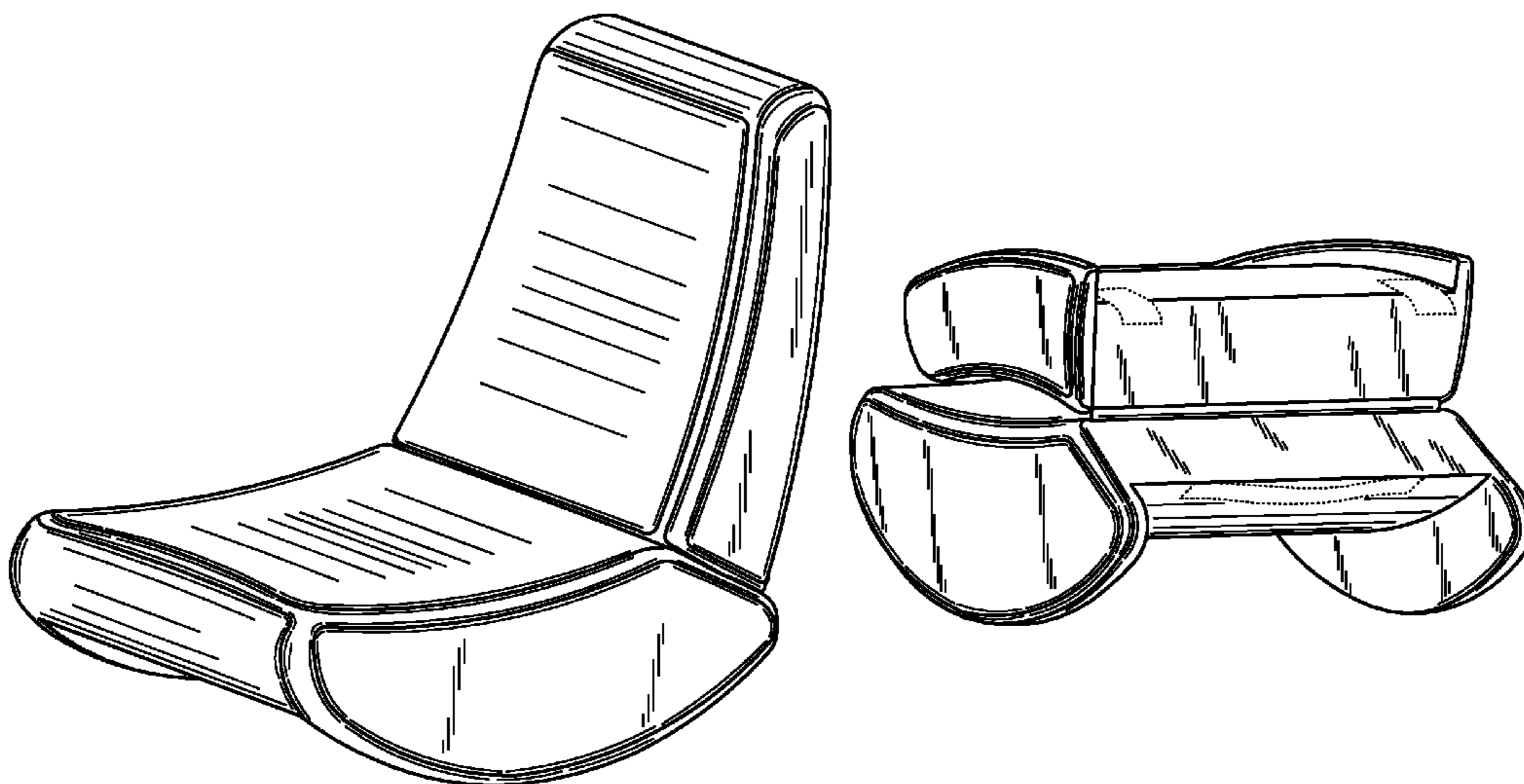

US D588,368 S

Page 2

U.S. PATENT DOCUMENTS

D462,557 S	9/2002	Scheetz	D6/601	D557,911 S	12/2007	Herold et al.	D6/356
D516,824 S	3/2006	Murphy	D6/356	D557,916 S	12/2007	Dietrich	D6/366
D524,385 S *	7/2006	Webb	D21/687	D557,921 S	12/2007	Kane	D6/375
D545,070 S	6/2007	Hutton	D6/334	D558,469 S	1/2008	Lade	D6/334
D548,986 S *	8/2007	McCoy et al.	D6/344	D558,491 S	1/2008	Kane	D6/500
D549,971 S *	9/2007	Jourdan	D6/344	D560,376 S	1/2008	Sempe	D6/334
D556,469 S	12/2007	Adams	D6/374	2008/0018160 A1	1/2008	Otto et al.	297/411.2

* cited by examiner

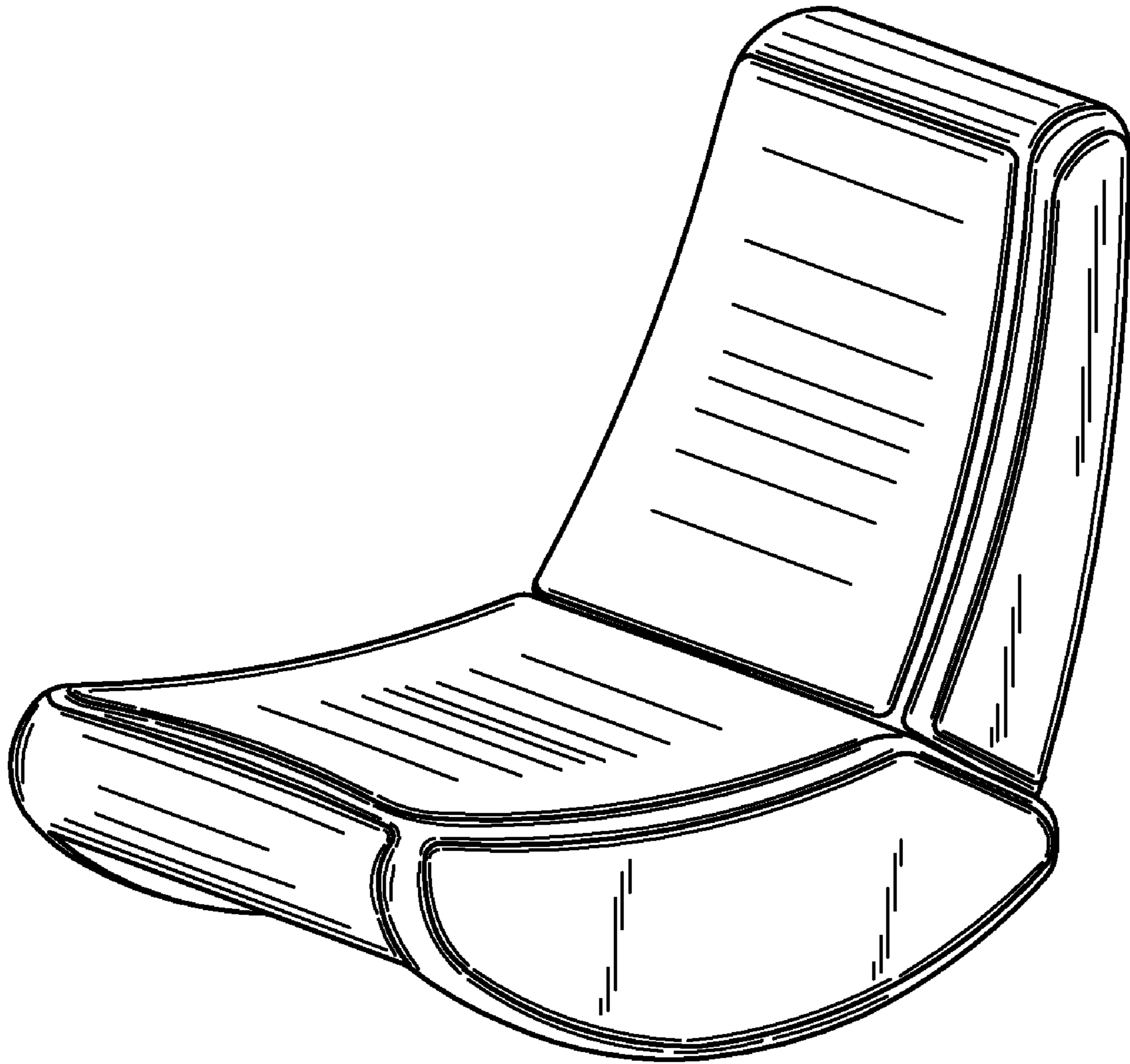

Fig. 1

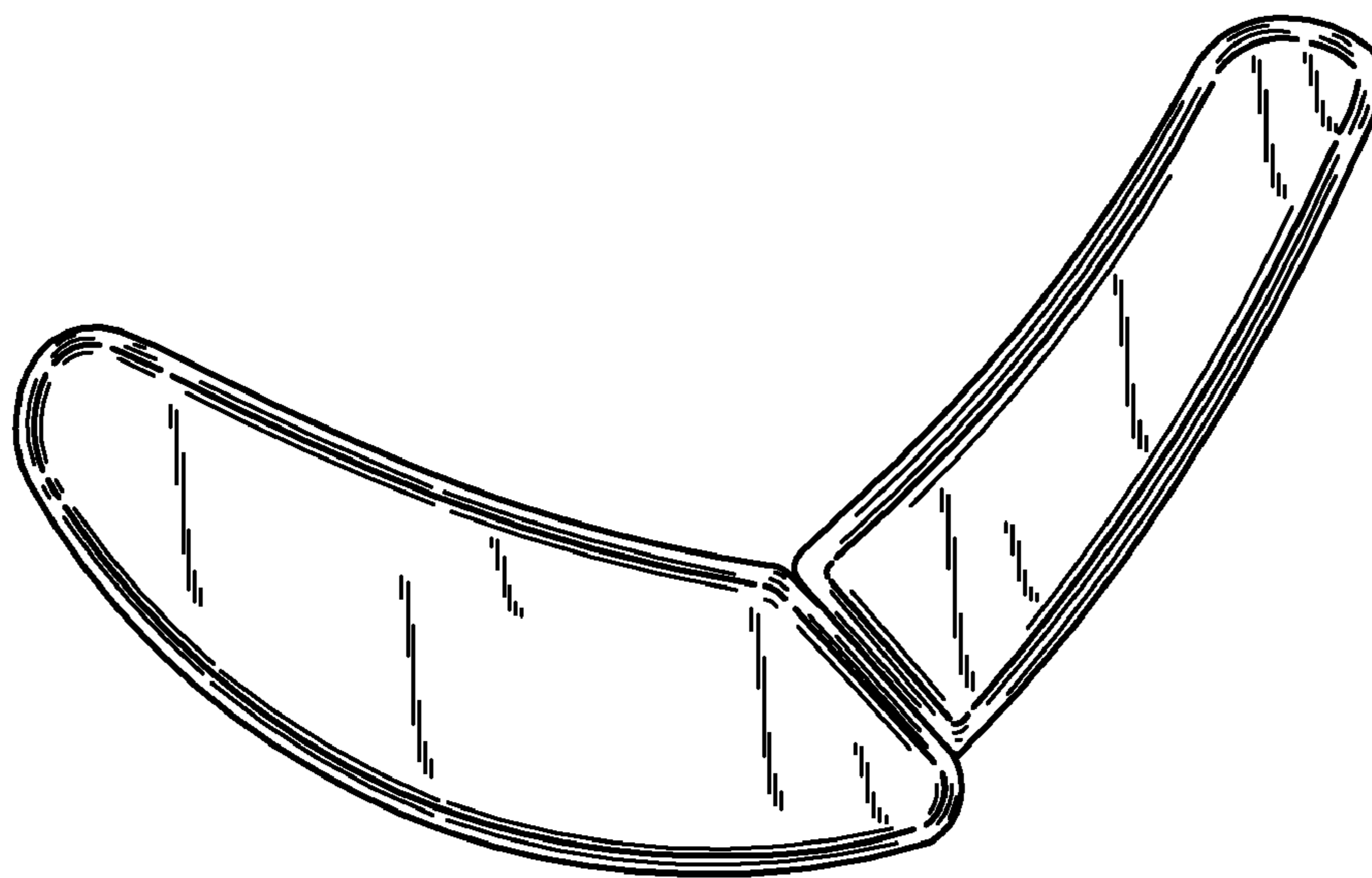

Fig. 2

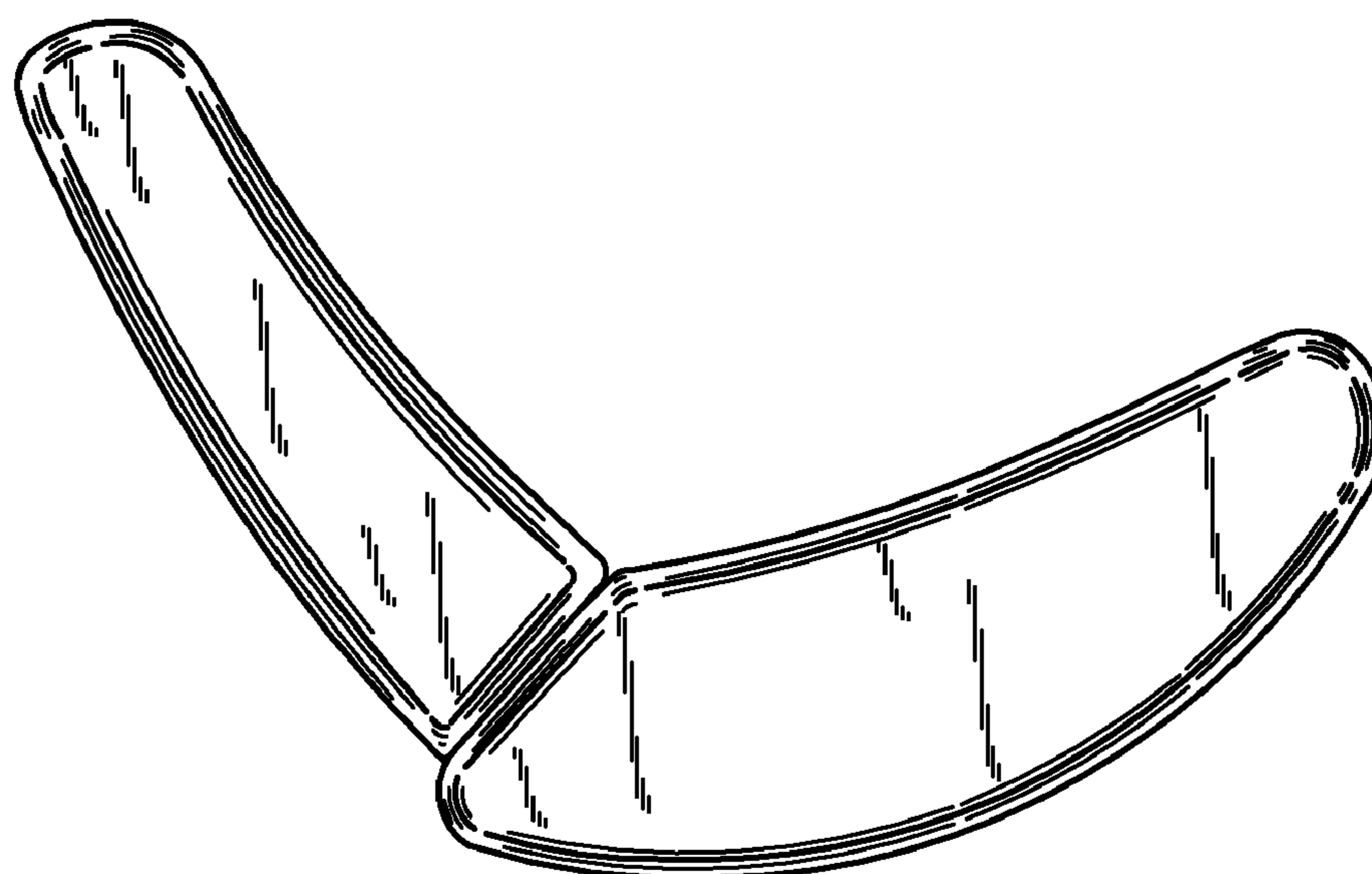

Fig. 3

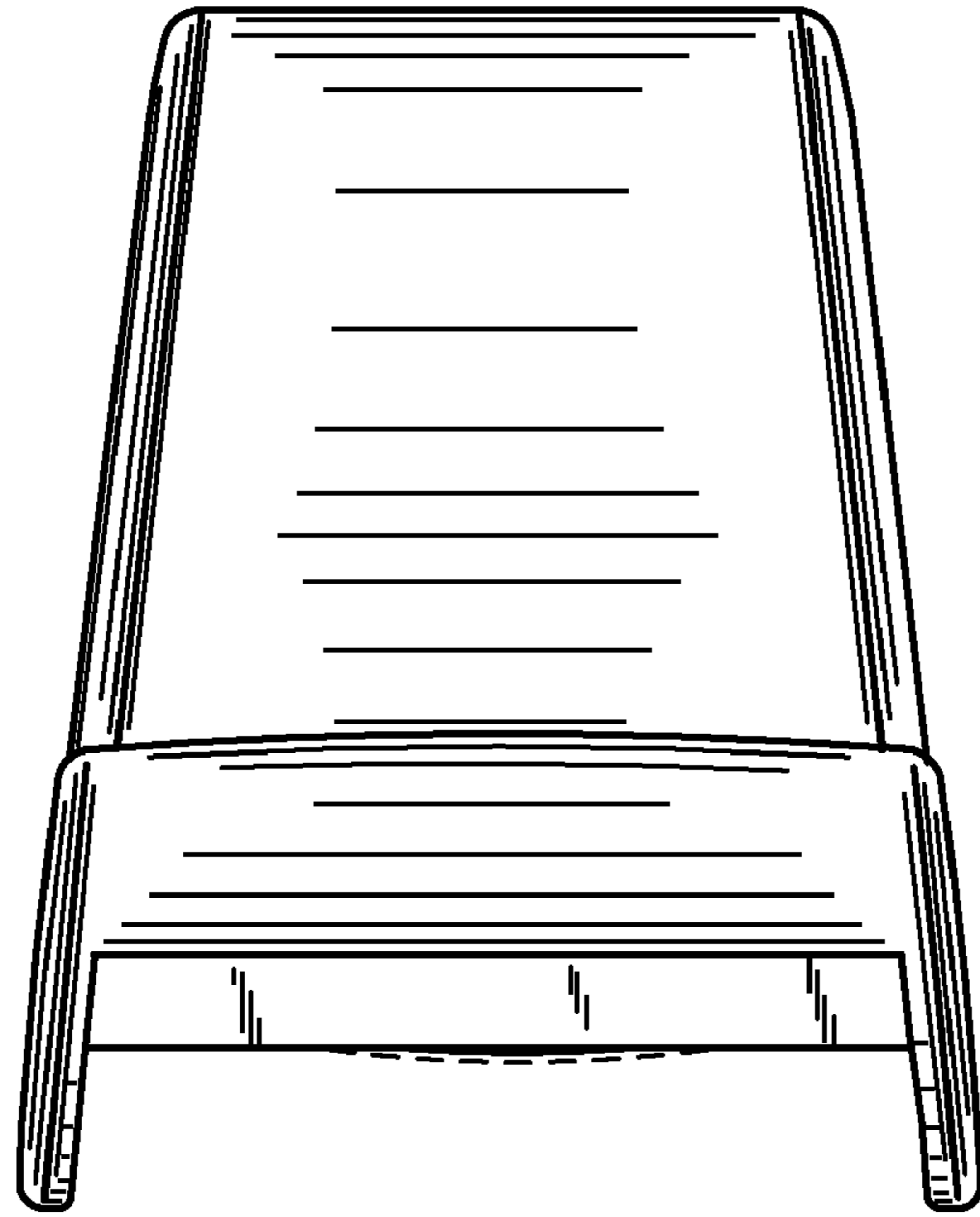

Fig. 4

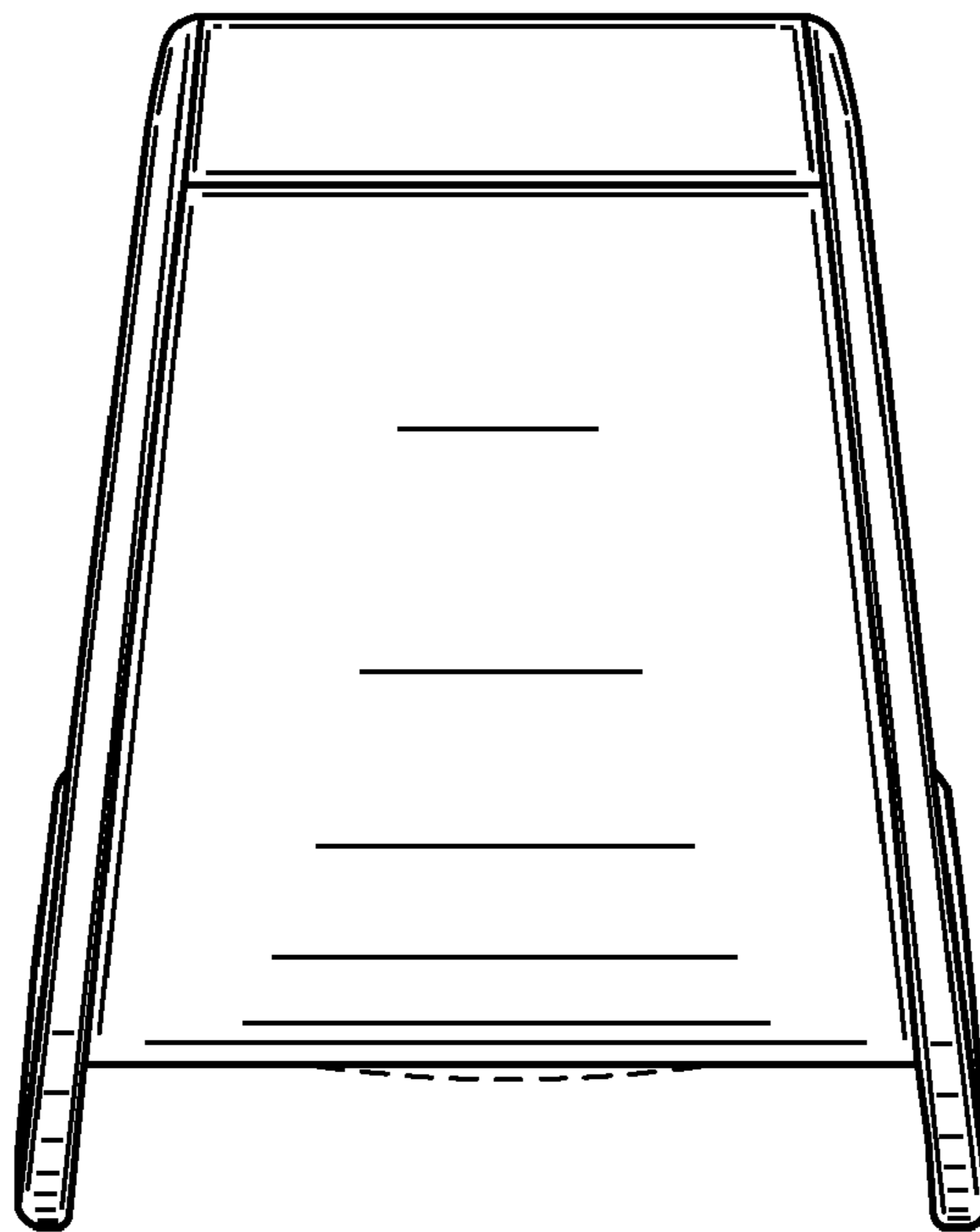

Fig. 5

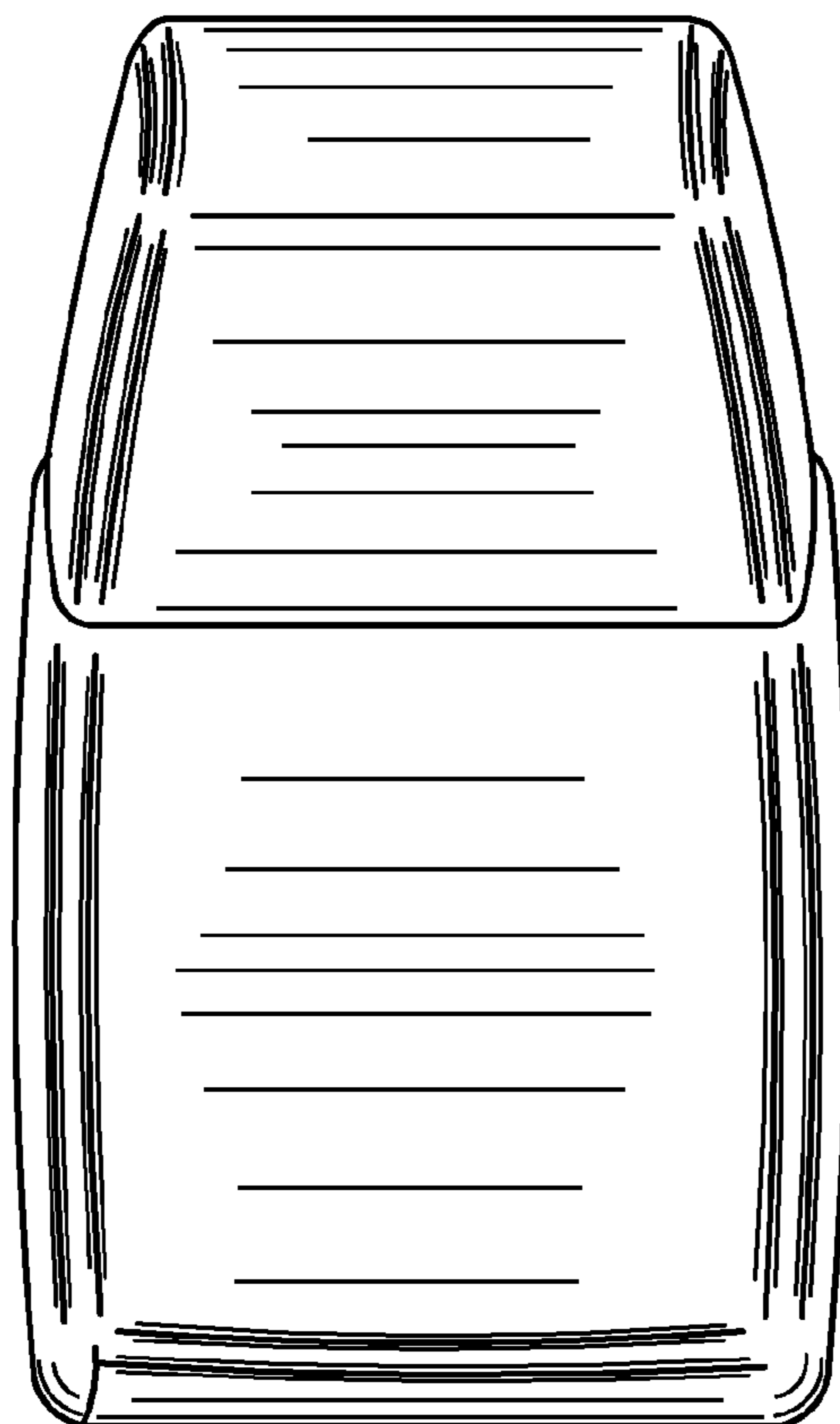

Fig. 6

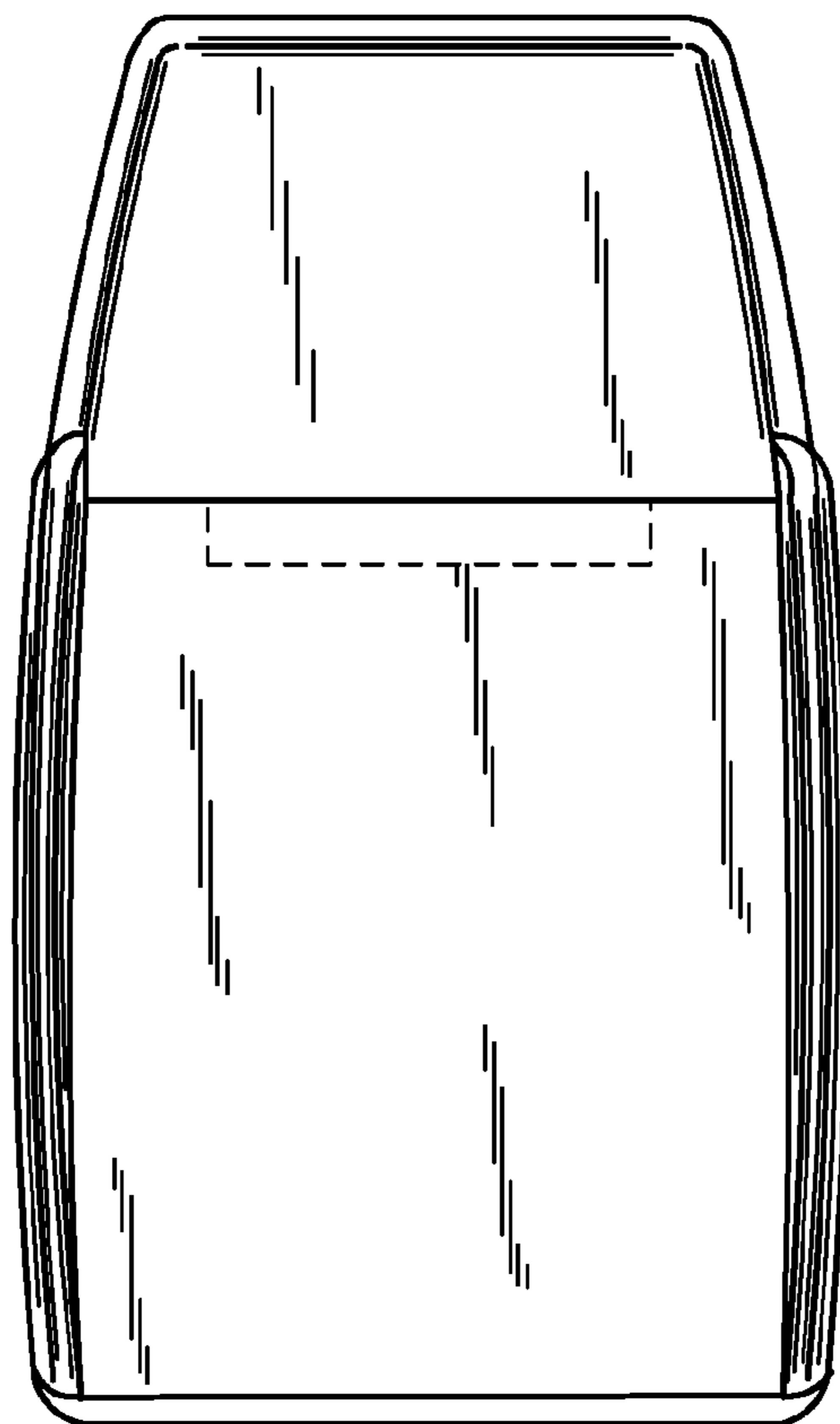

Fig. 7

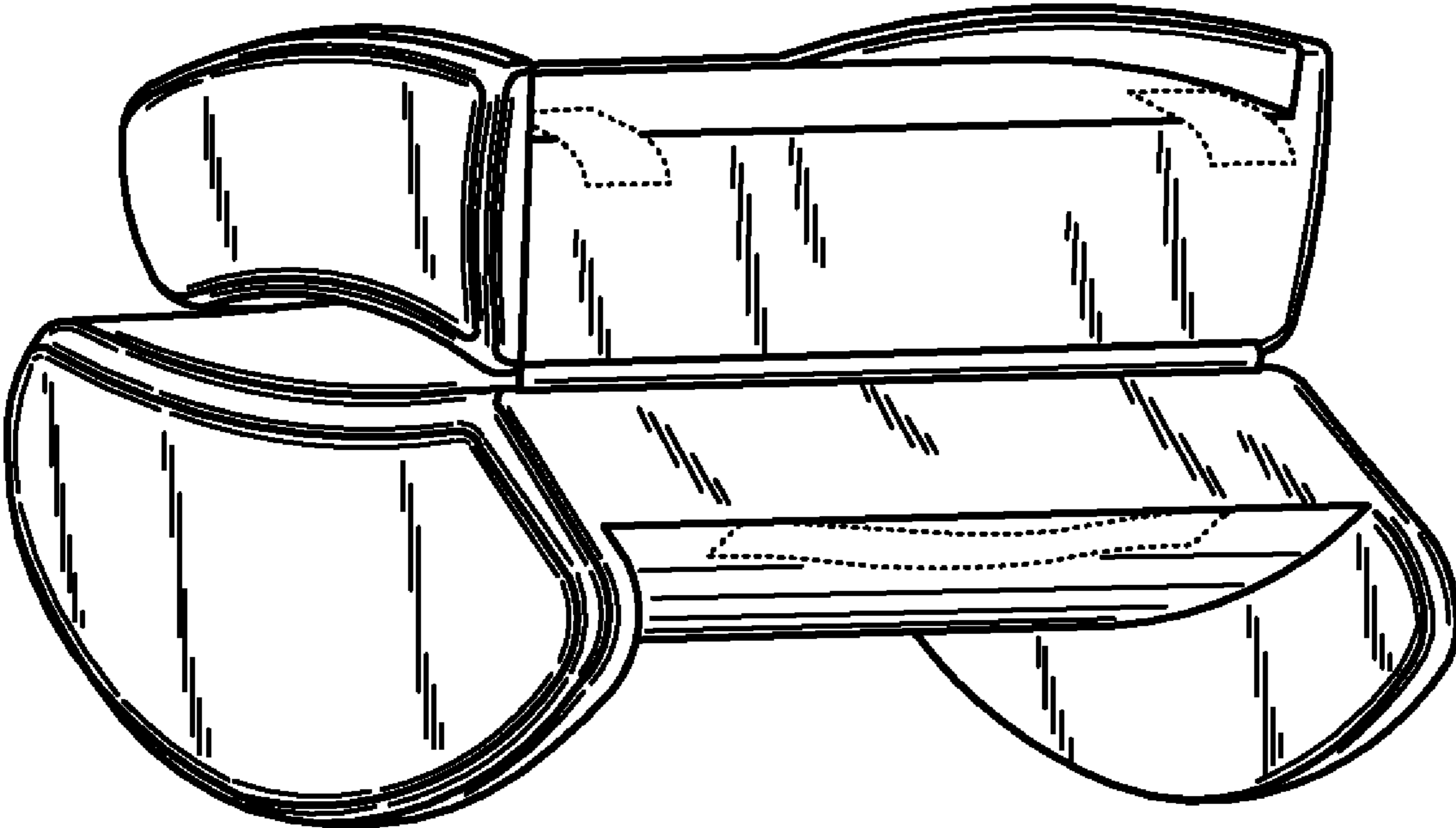

Fig. 8

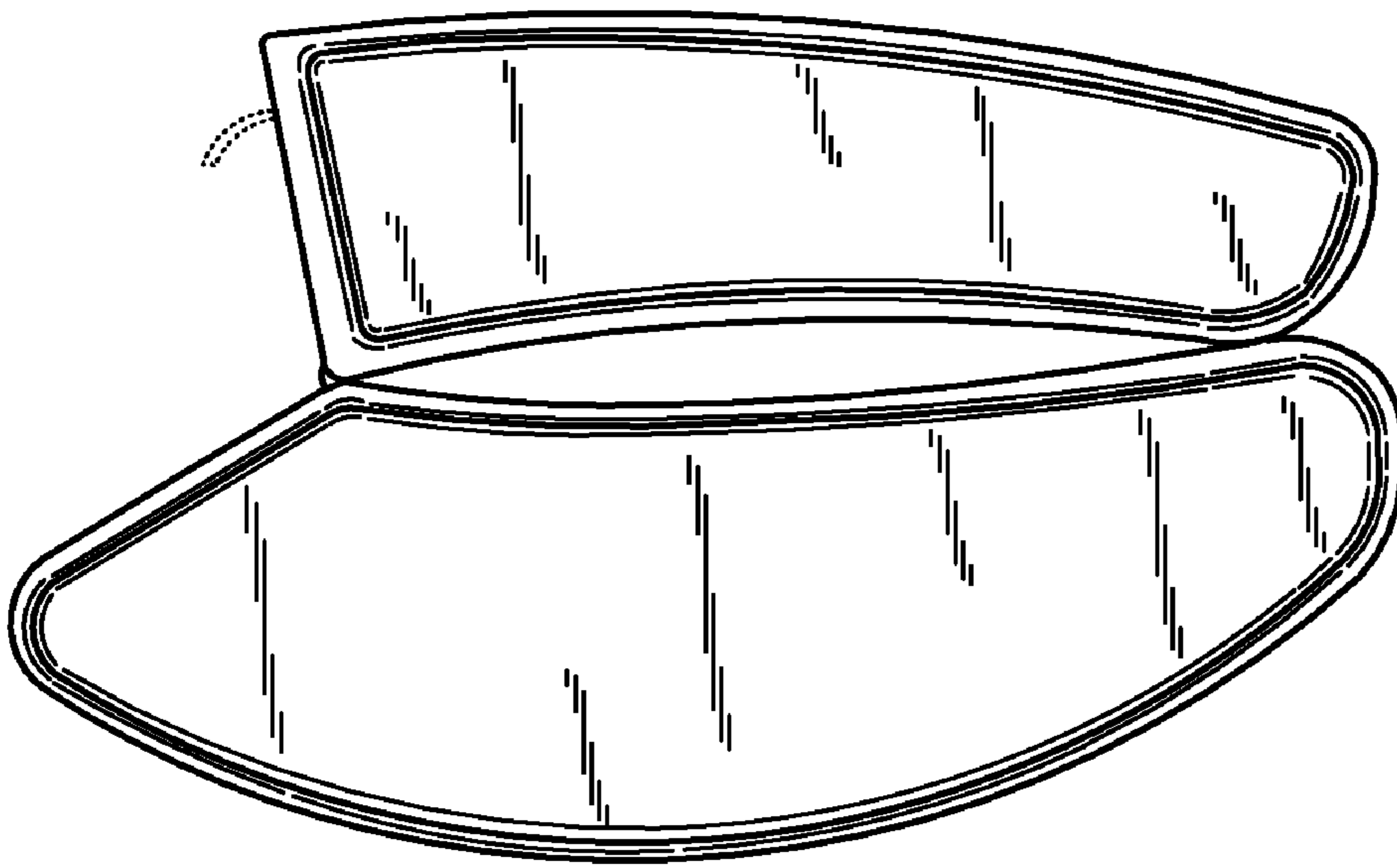

Fig. 9

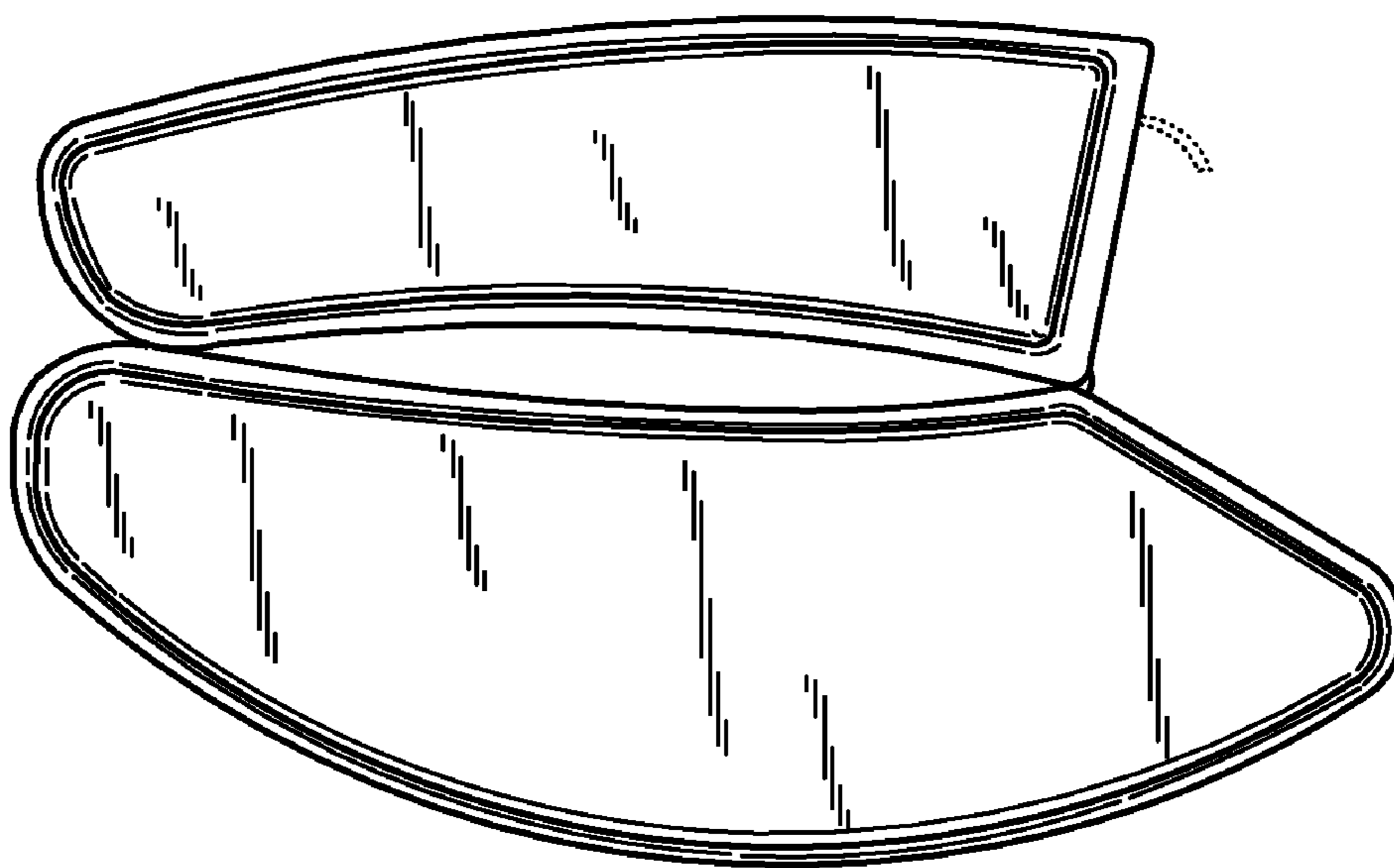

Fig. 10

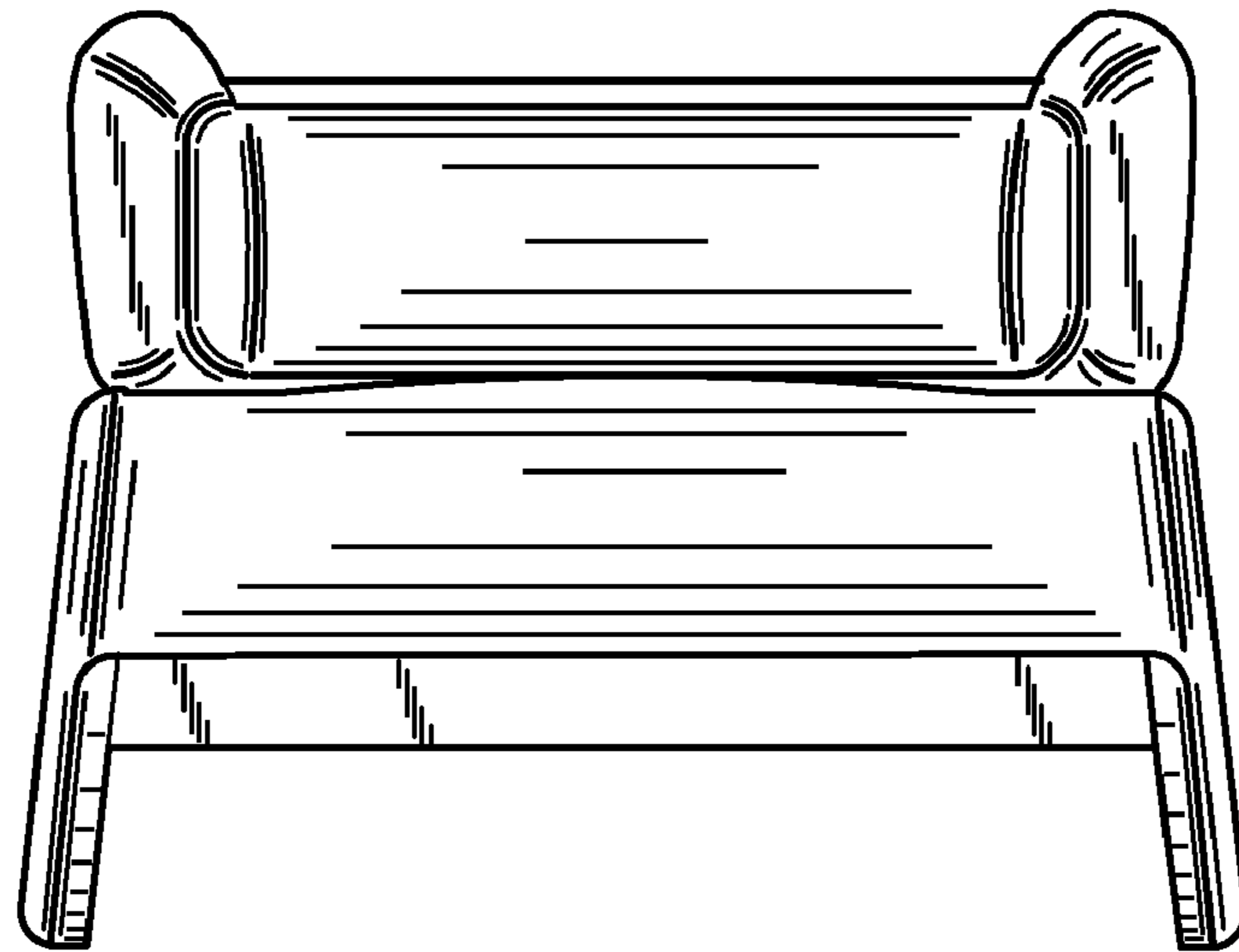

Fig. 11

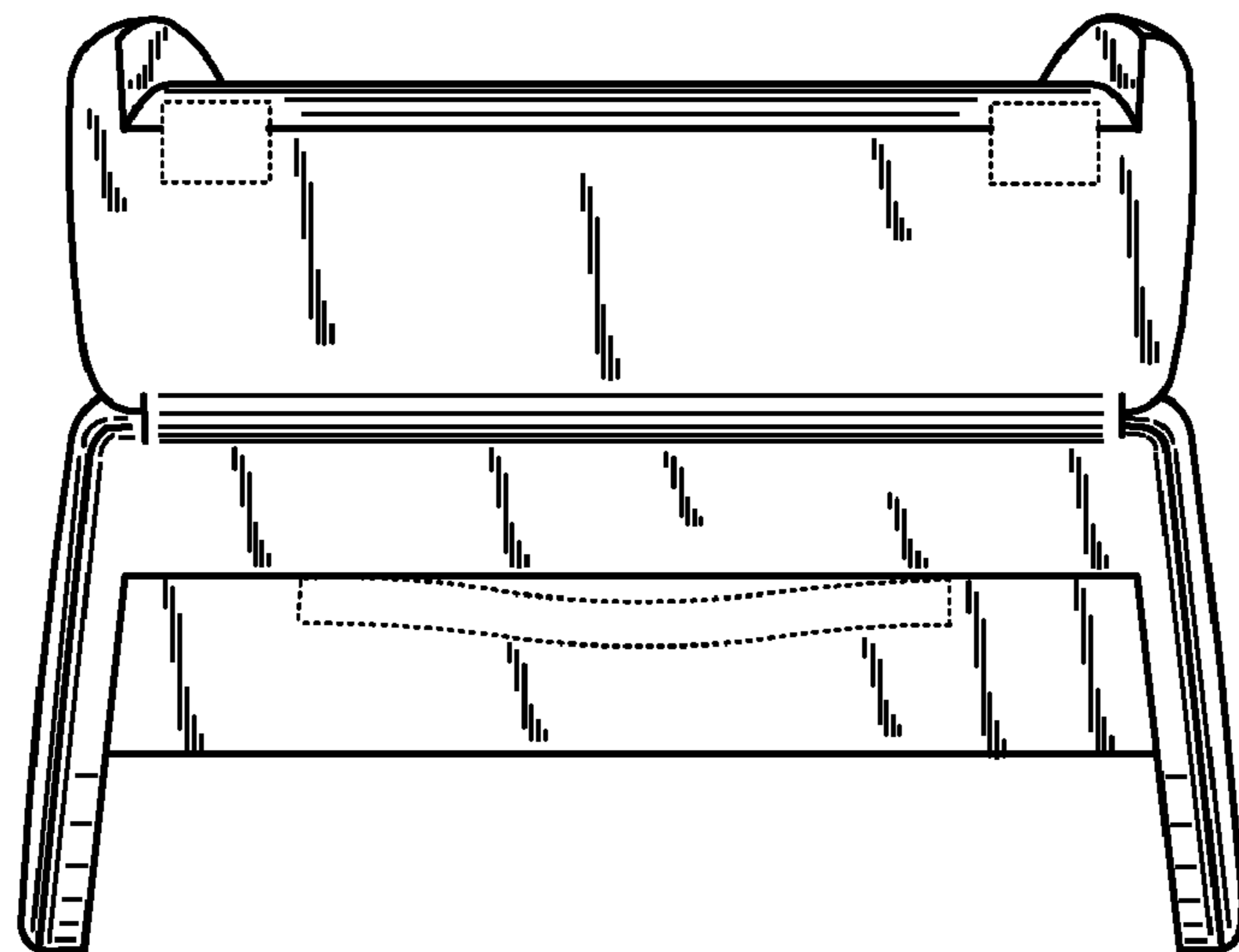

Fig. 12

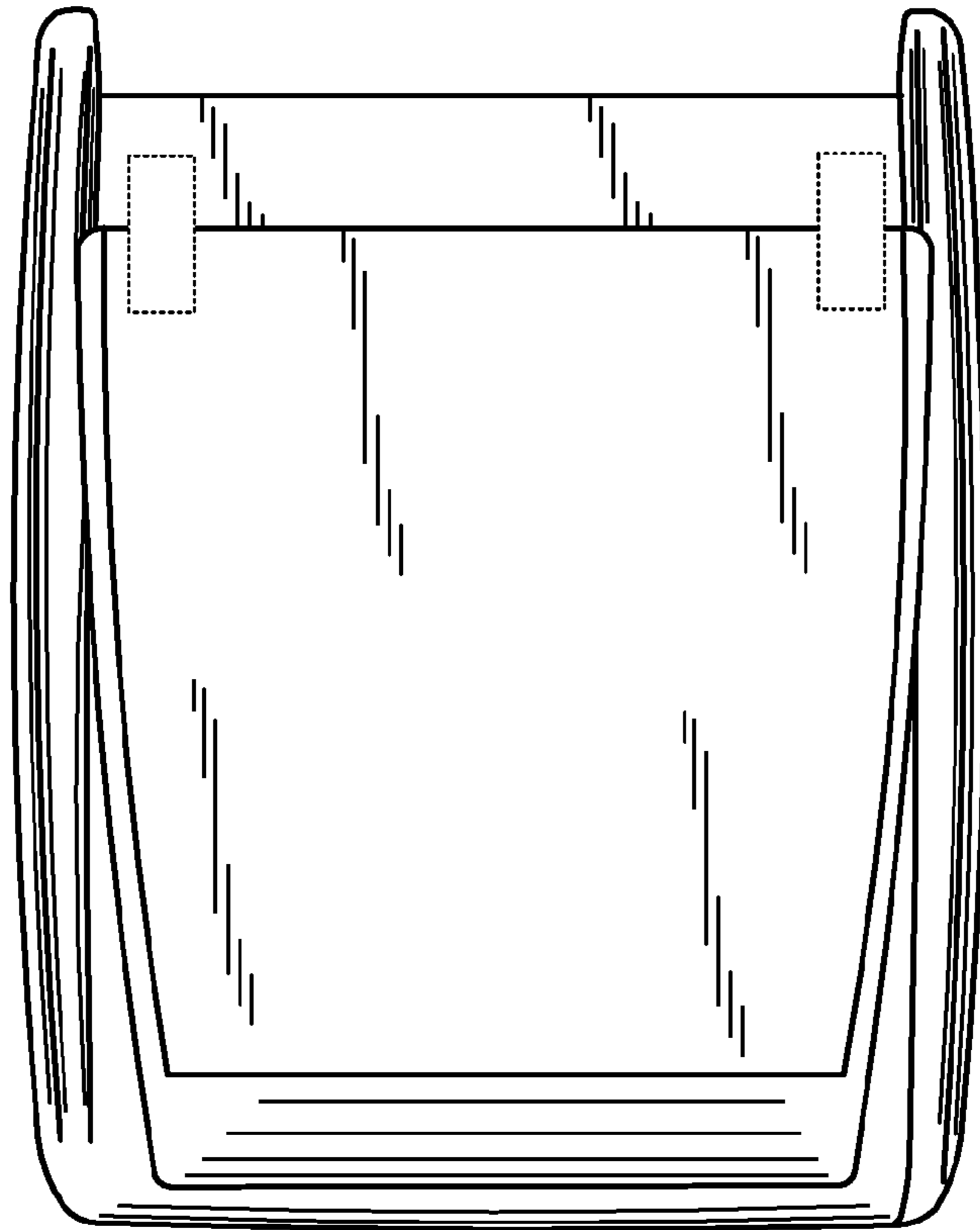

Fig. 13

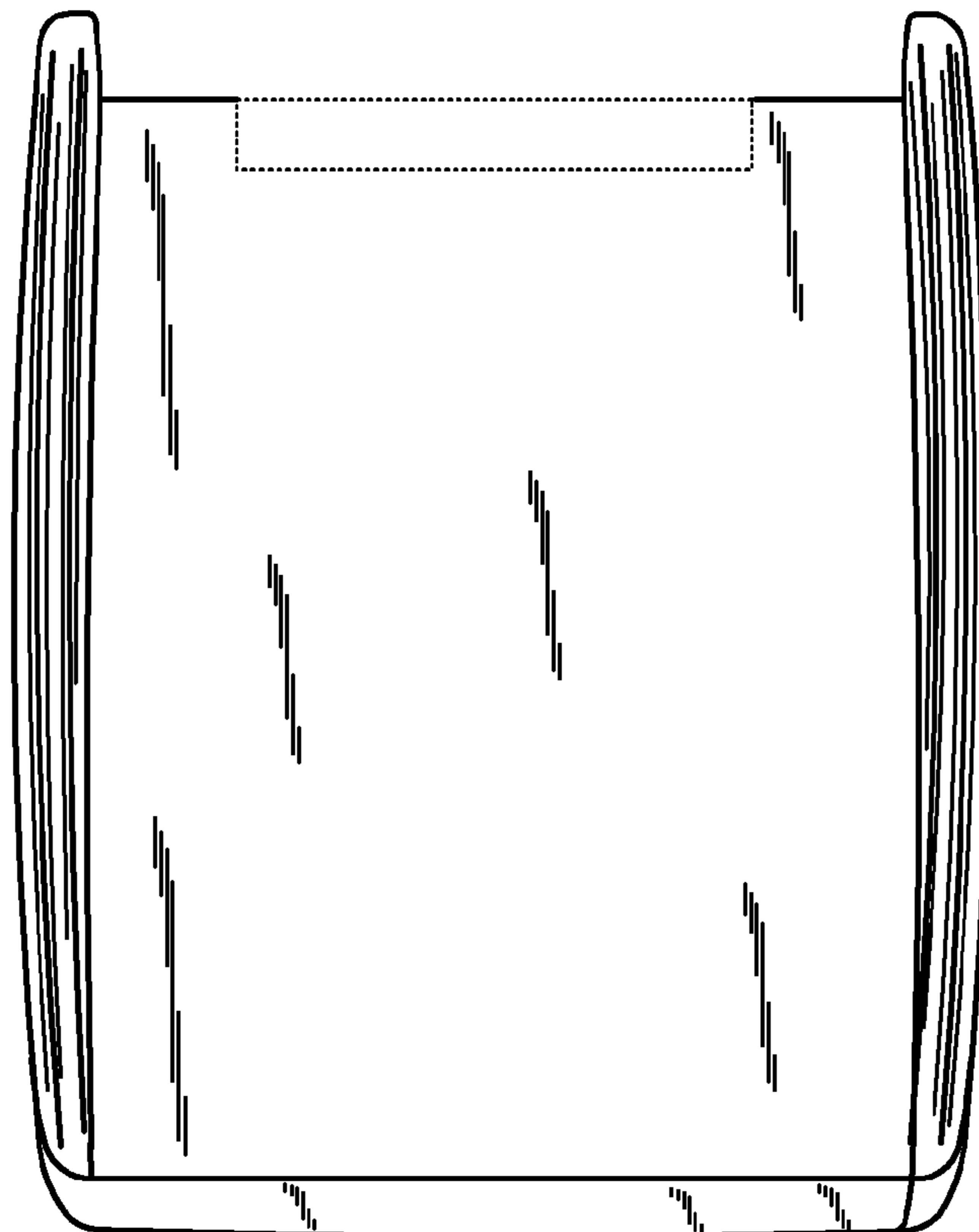

Fig. 14