



US00D588363S

(12) **United States Design Patent**
Nanda

(10) **Patent No.:** **US D588,363 S**
(45) **Date of Patent:** **** *Mar. 17, 2009**

(54) **TOOTHBRUSH**

(75) Inventor: **Puneet Nanda**, Cerritos, CA (US)

(73) Assignee: **Dr. Fresh, Inc.**, Buena Park, CA (US)

(*) Notice: This patent is subject to a terminal disclaimer.

(**) Term: **14 Years**

(21) Appl. No.: **29/277,243**

(22) Filed: **Feb. 19, 2007**

Related U.S. Application Data

(63) Continuation-in-part of application No. 11/503,566, filed on Aug. 11, 2006.

(51) **LOC (9) Cl.** **04-02**

(52) **U.S. Cl.** **D4/104**

(58) **Field of Classification Search** D4/101, D4/104-112, 114, 132, 134, 138; D24/133, D24/146, 152; 15/143.1, 167.1, 167.2; 132/308-311
See application file for complete search history.

(56) **References Cited**

U.S. PATENT DOCUMENTS

- 851,550 A 4/1907 Nevius
- D136,566 S * 10/1943 Watt D4/108
- 2,391,371 A 12/1945 Watt
- 2,456,904 A 12/1948 Wahlstrom
- 3,019,572 A 2/1962 Berry et al.
- 3,324,997 A 6/1967 Bonanno
- 3,333,536 A 8/1967 Messersmith
- 3,884,635 A 5/1975 Sloan
- 4,214,657 A 7/1980 Winston
- 5,000,376 A 3/1991 Wojdyla
- D317,718 S 6/1991 Carol
- 5,617,884 A 4/1997 Allison
- 5,875,796 A 3/1999 Silver-Isenstadt et al.
- 5,956,796 A 9/1999 Lodato
- D414,867 S * 10/1999 Moriwaki et al. D24/152
- 6,231,904 B1 5/2001 Mueller
- 6,309,088 B1 10/2001 Chen
- D458,454 S 6/2002 Nanda
- D458,758 S 6/2002 Nanda
- 6,606,755 B1 8/2003 Robinson et al.
- D490,247 S 5/2004 Nanda

- D492,116 S 6/2004 Nanda
- D492,996 S * 7/2004 Rehkemper et al. D24/152
- D508,399 S 8/2005 Nanda
- 7,201,172 B2 4/2007 Nanda
- 2002/0124864 A1 * 9/2002 Gross et al. 132/311
- 2004/0143920 A1 7/2004 Nanda
- 2006/0174431 A1 8/2006 Nanda
- 2007/0039109 A1 2/2007 Nanda
- 2007/0131241 A1 6/2007 Nanda

FOREIGN PATENT DOCUMENTS

- DE 3523891 A1 * 6/1986
- KR 30-0413356 S * 5/2006
- WO WO 2004024016 A2 * 3/2004

OTHER PUBLICATIONS

International Search Report for Application No. PCT-US06-31350 (the PCT counterpart of the parent application) mailed Jul. 30, 2007.

* cited by examiner

Primary Examiner—Melanie H Tung

Assistant Examiner—Lavone D Tabor

(74) *Attorney, Agent, or Firm*—Knobbe, Martens, Olson & Bear, LLP

(57) **CLAIM**

The ornamental design for a toothbrush, as shown and described.

DESCRIPTION

FIG. 1 is a top, front, and left side perspective of a toothbrush embodying my new design.

FIG. 2 is a top, rear, and right perspective of FIG. 1.

FIG. 3 is a front elevation view of FIG. 1.

FIG. 4 is a rear elevation view of FIG. 1.

FIG. 5 is a left side elevation view of FIG. 1.

FIG. 6 is a right side elevation view of FIG. 1.

FIG. 7 is a top plan view of FIG. 1; and,

FIG. 8 is a bottom plan view of FIG. 1.

The broken lines showing bristles illustrate portions of the toothbrush that form no part of the claimed design.

1 Claim, 5 Drawing Sheets

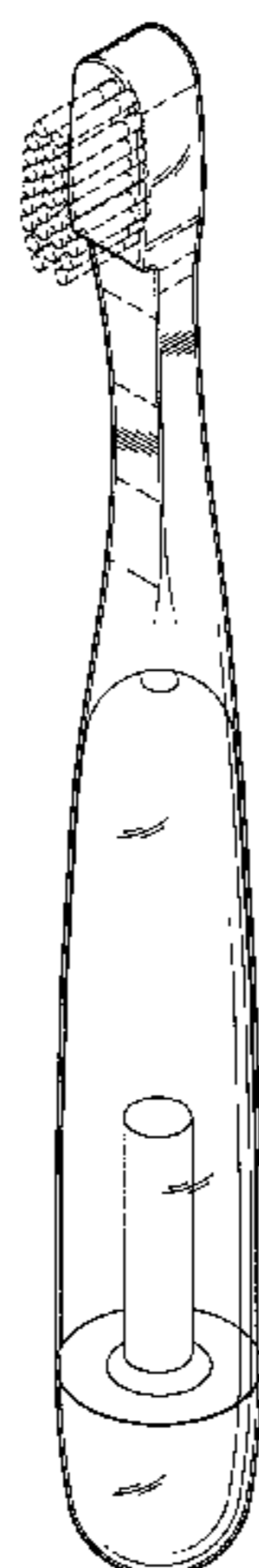

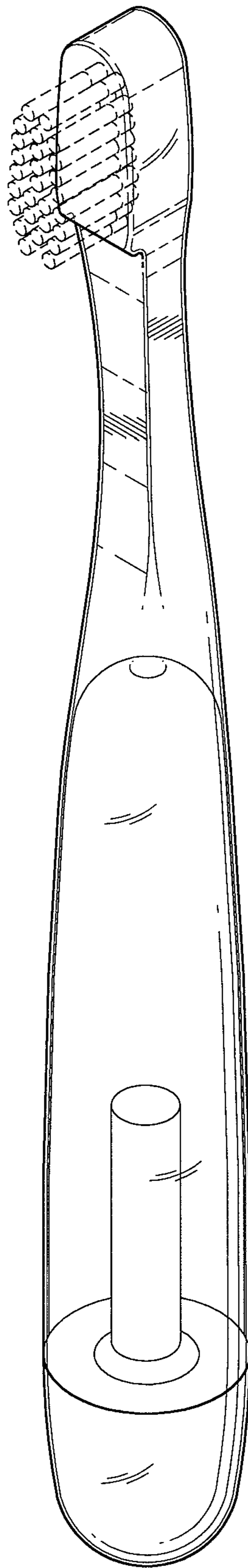

FIG. 1

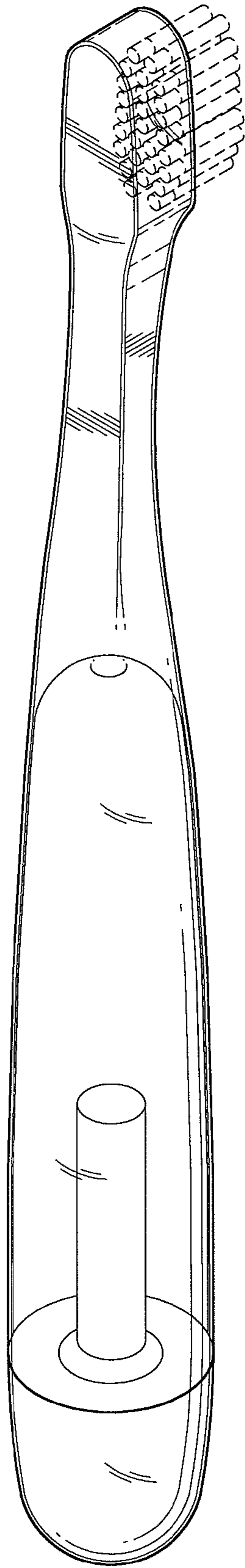

FIG. 2

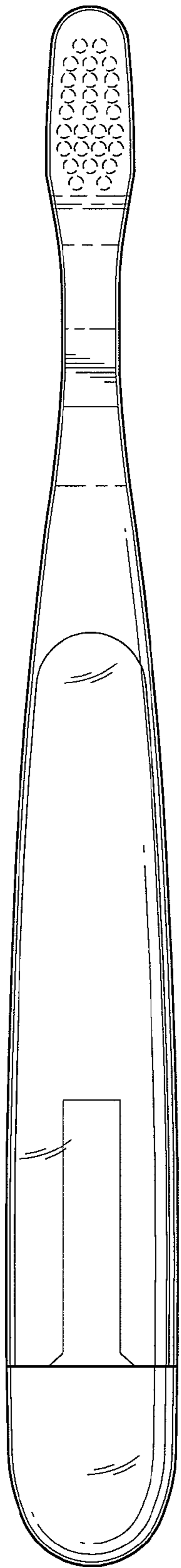

FIG. 3

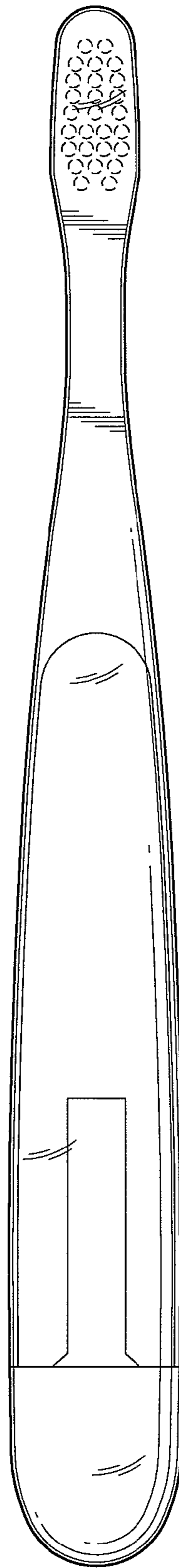

FIG. 4

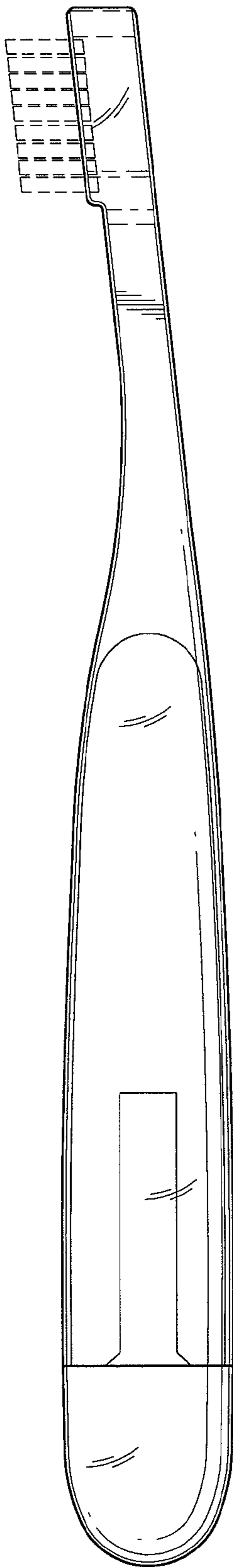

FIG. 5

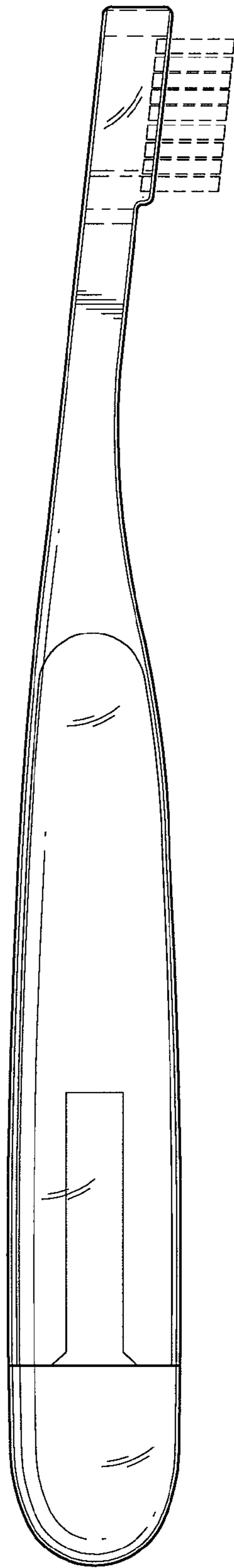

FIG. 6

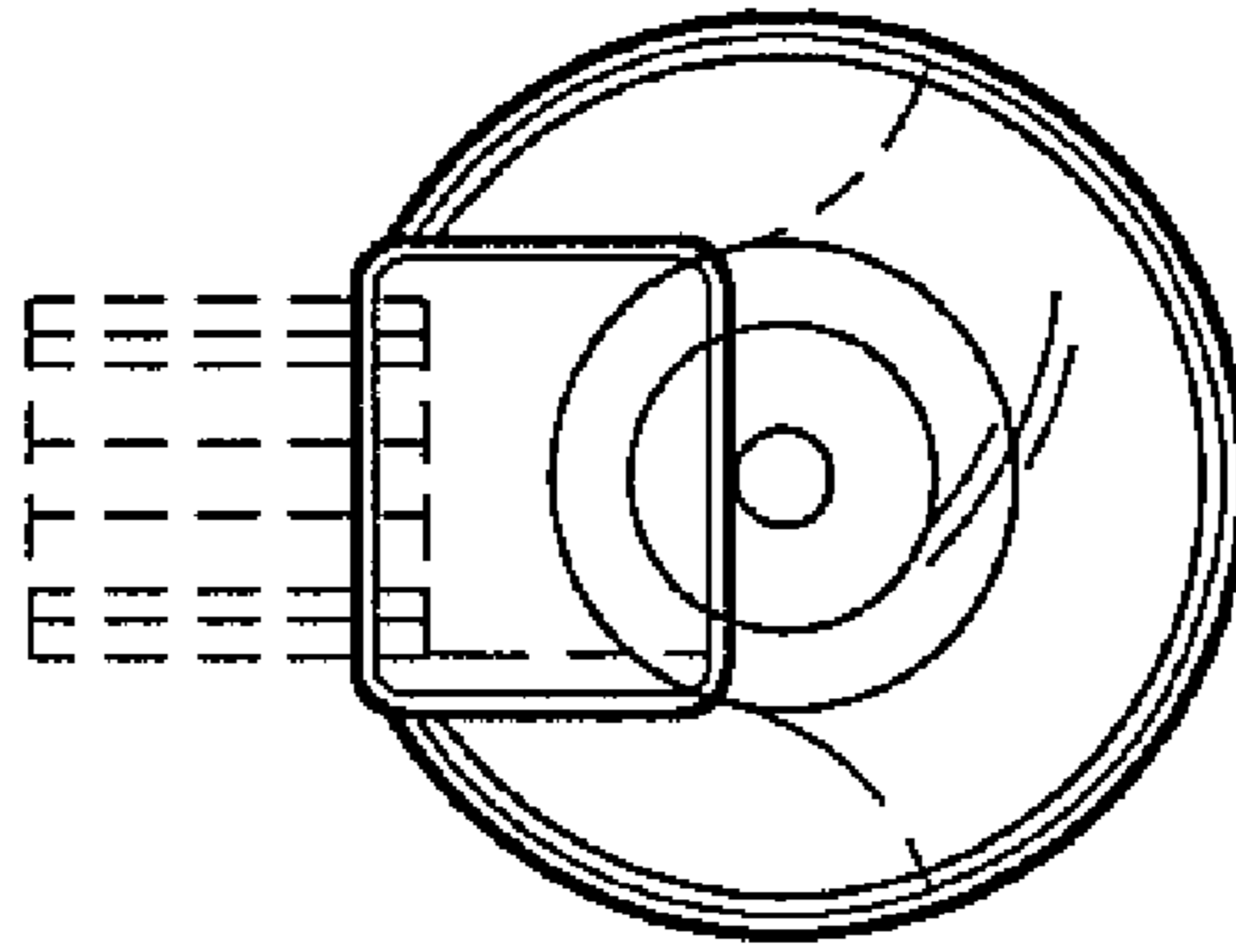

FIG. 7

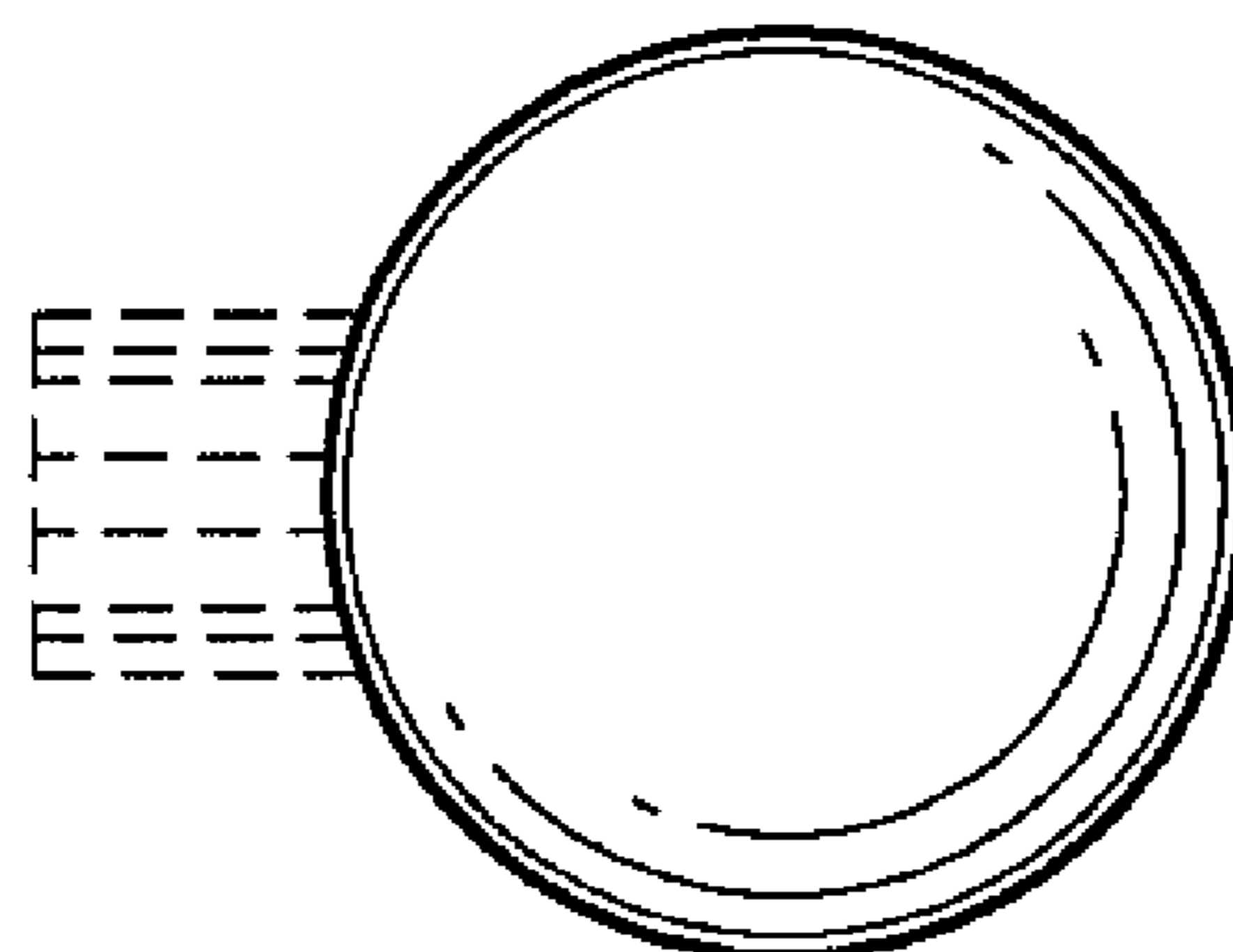

FIG. 8