



US00D588358S

(12) **United States Design Patent**
Gonzalez

(10) **Patent No.:** **US D588,358 S**
(45) **Date of Patent:** **** Mar. 17, 2009**

(54) **HANDBAG**

(75) Inventor: **Alvaro Gonzalez**, Florence (IT)

(73) Assignee: **J. Choo Limited**, London (GB)

(**) Term: **14 Years**

(21) Appl. No.: **29/271,659**

(22) Filed: **Jan. 23, 2007**

(51) **LOC (9) Cl.** **03-01**

(52) **U.S. Cl.** **D3/243**

(58) **Field of Classification Search** D3/232–233,
D3/240–246, 318, 322, 324; 150/100, 103–104,
150/107–110, 114, 118–119

See application file for complete search history.

(56) **References Cited**

U.S. PATENT DOCUMENTS

D246,680 S *	12/1977	Sabol	D3/243
D507,882 S	8/2005	Gonzalez		
D532,200 S	11/2006	Gonzalez		
D543,026 S *	5/2007	Gonzalez	D3/243
D547,945 S *	8/2007	Gonzalez	D3/243
D579,206 S	10/2008	Gonzalez		

* cited by examiner

Primary Examiner—Holly H Baynham

(74) *Attorney, Agent, or Firm*—Fross Zelnick Lehrman & Zissu, P.C.; Lawrence E. Apolzon, Esq.

(57) **CLAIM**

The ornamental design for handbag, as shown and described.

DESCRIPTION

FIG. 1 is a front perspective view of the handbag shown

FIG. 2 is a front view of the handbag;

FIG. 3 is a rear view of the handbag;

FIG. 4 is a left side view of the handbag;

FIG. 5 is a right side view of the handbag;

FIG. 6 is a top view of the handbag; and,

FIG. 7 is a bottom view of the handbag.

The broken line showing of the buckle and hanging strap, front closure flap, and clips of the upper handle strap is for illustrative purposes only and forms no part of the claimed design.

1 Claim, 7 Drawing Sheets

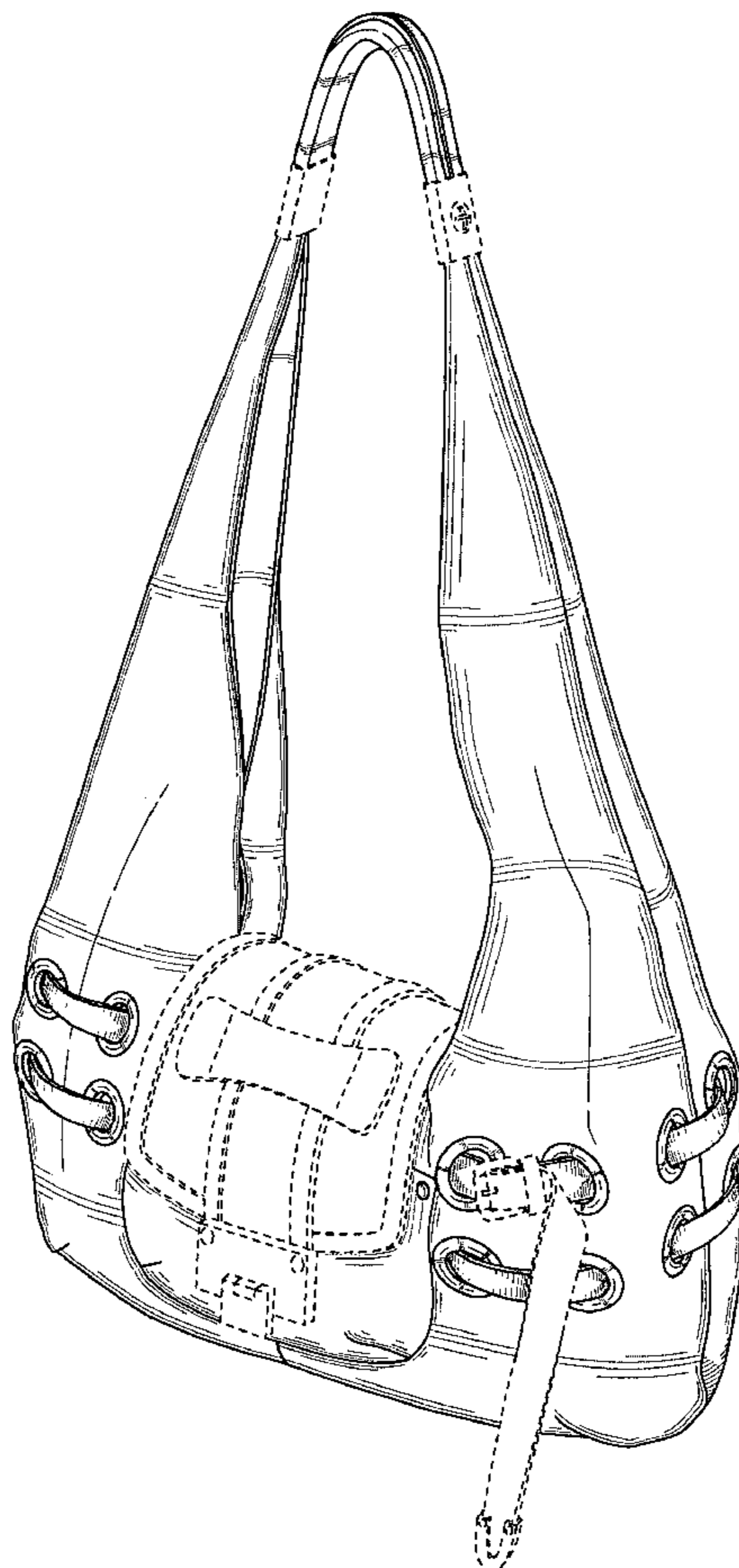

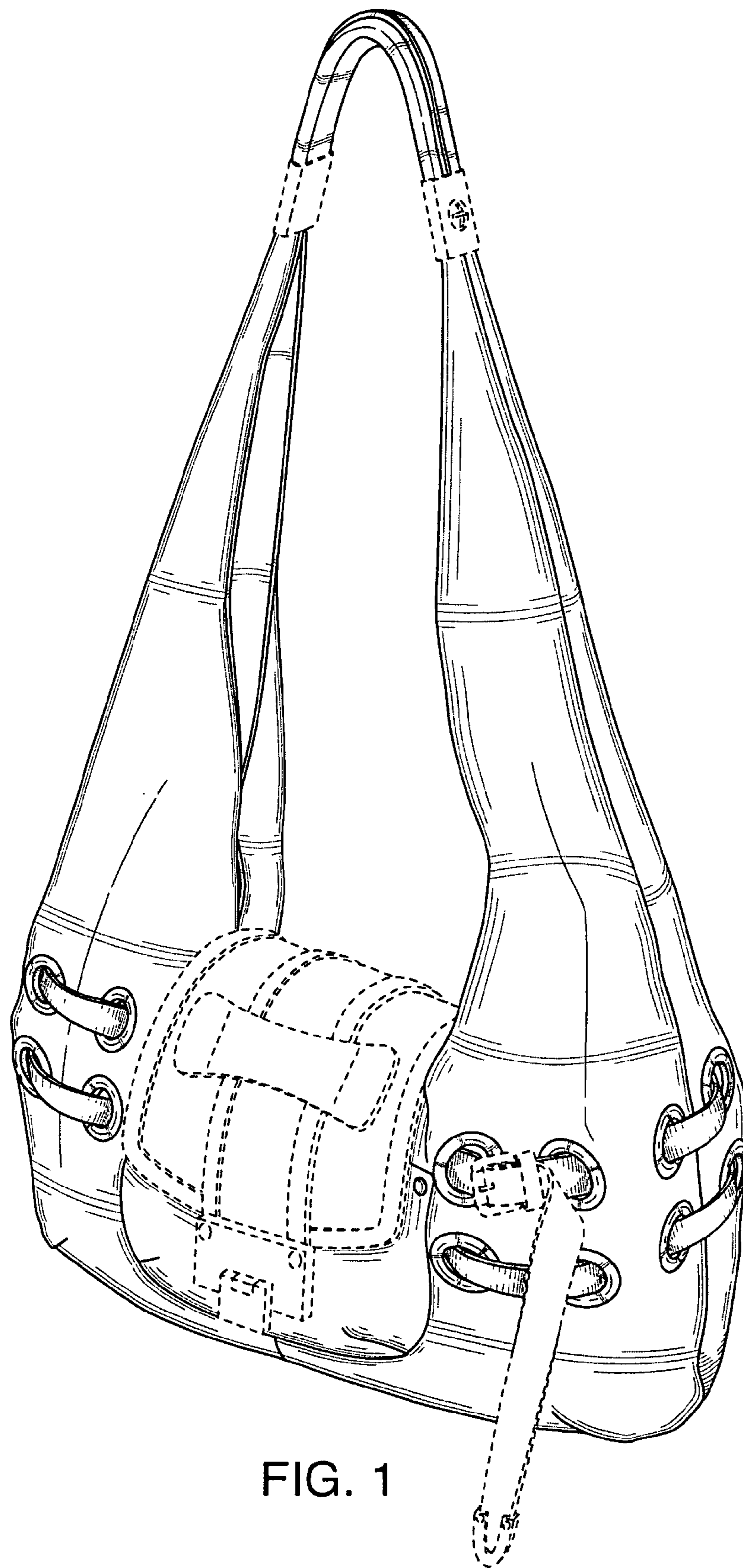

FIG. 1

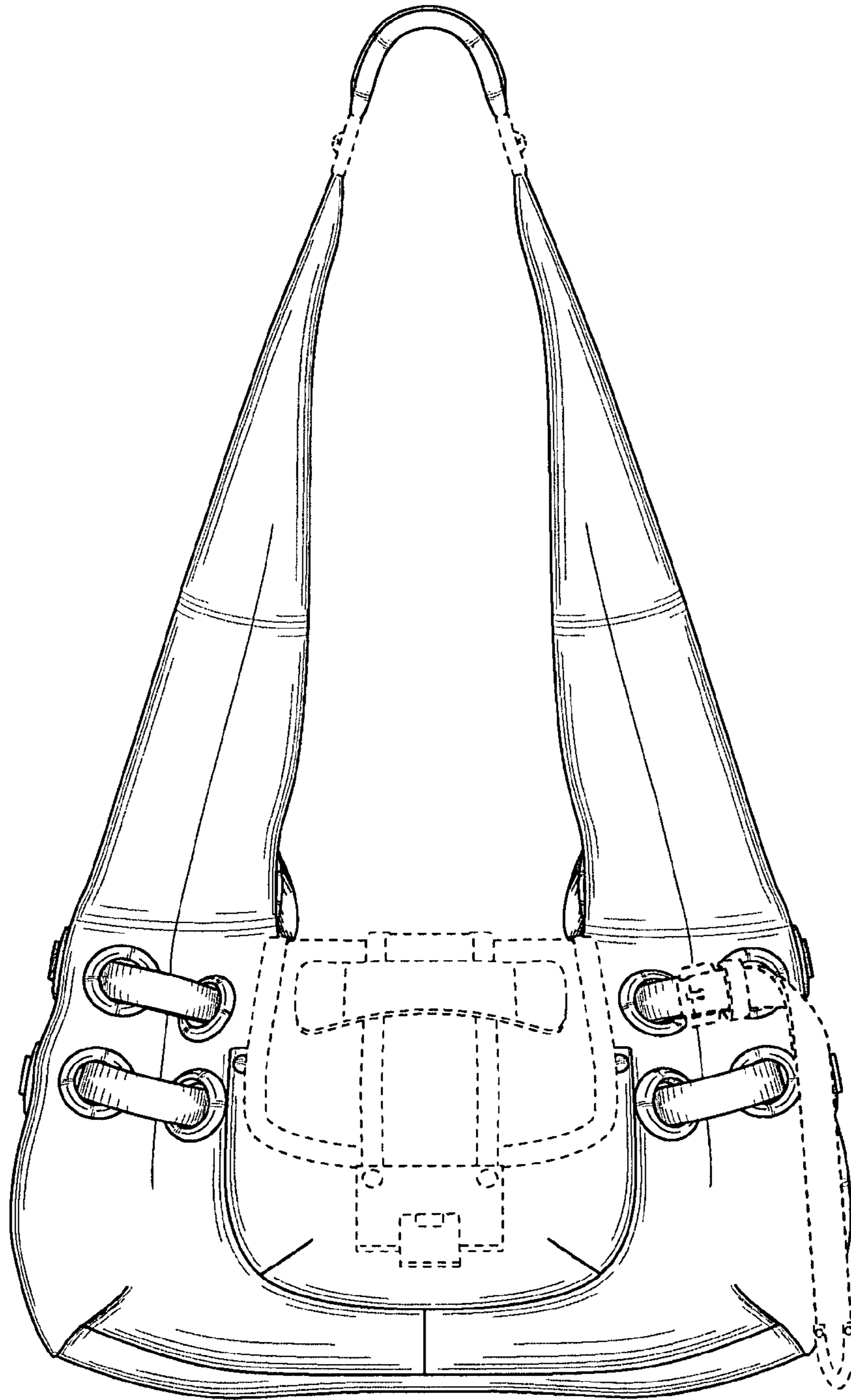

FIG. 2

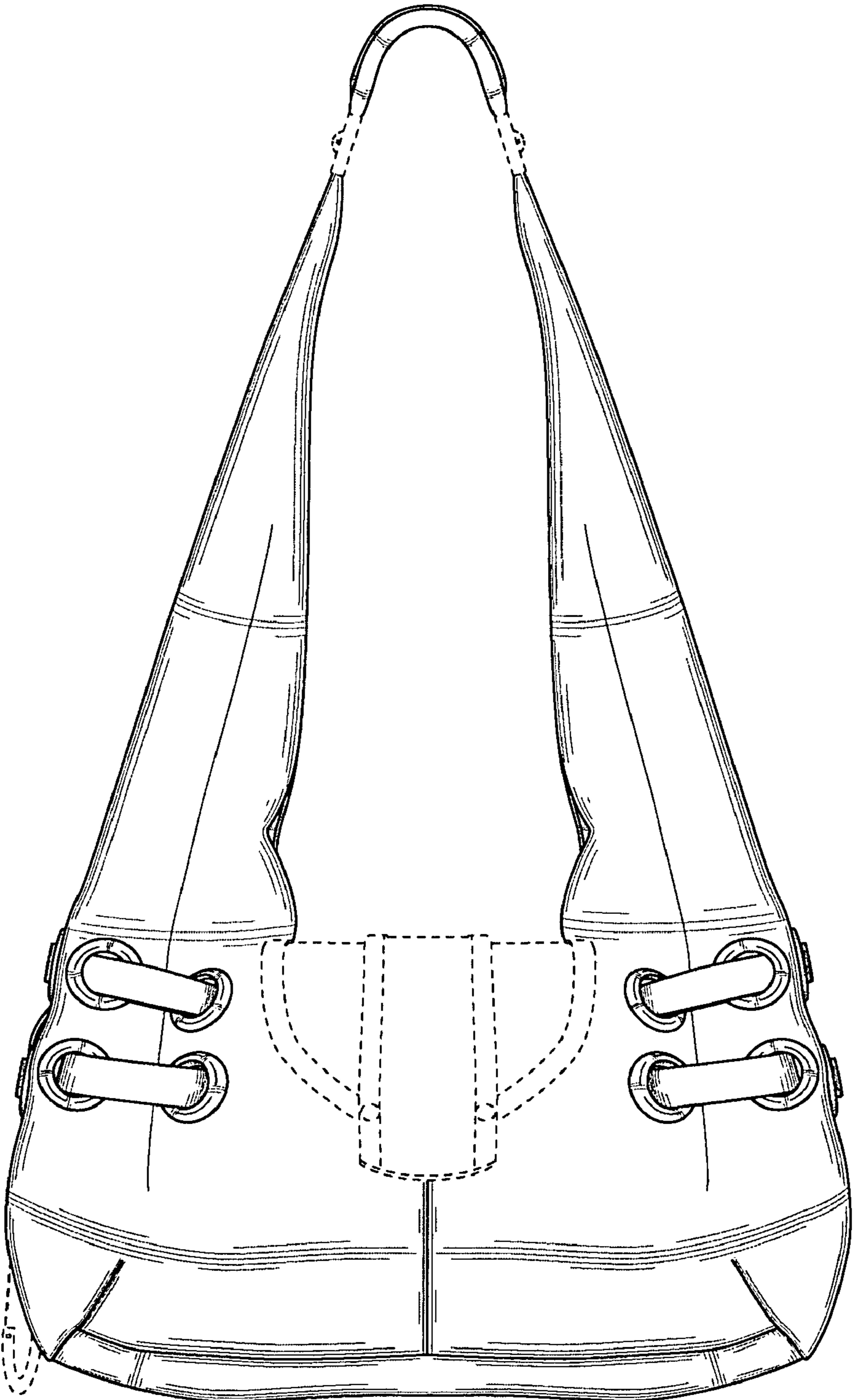

FIG. 3

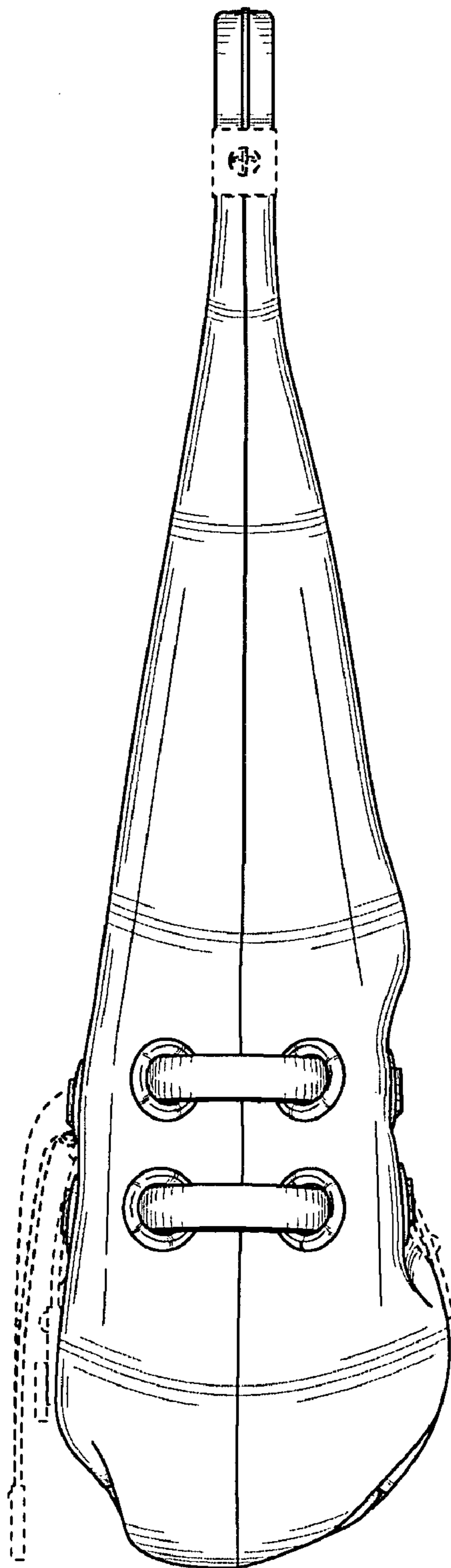

FIG. 4

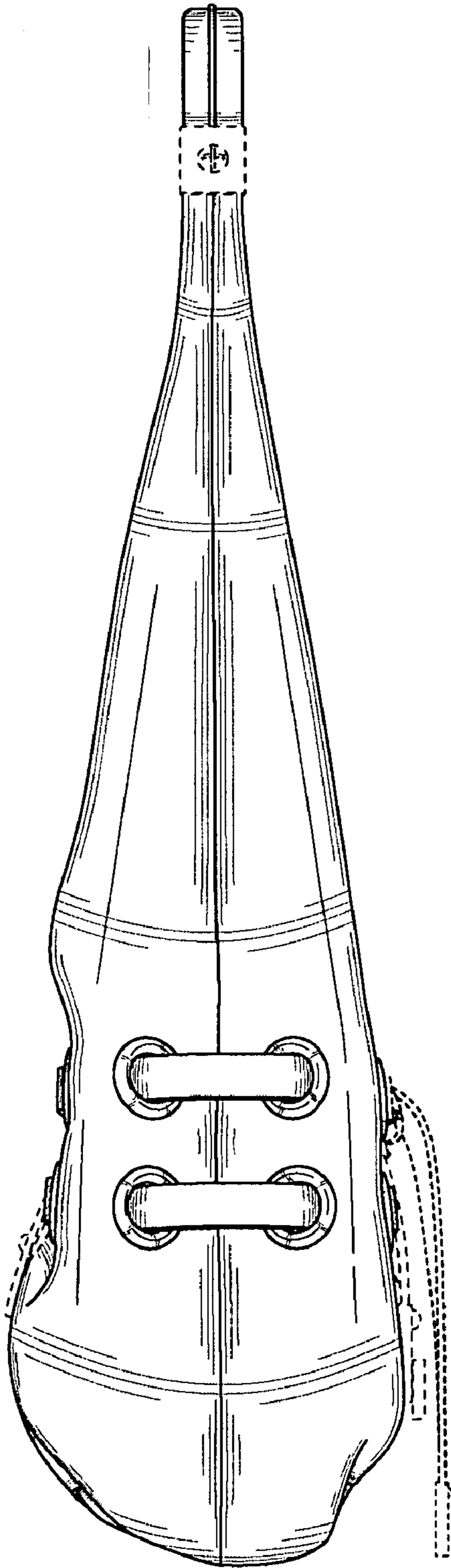

FIG. 5

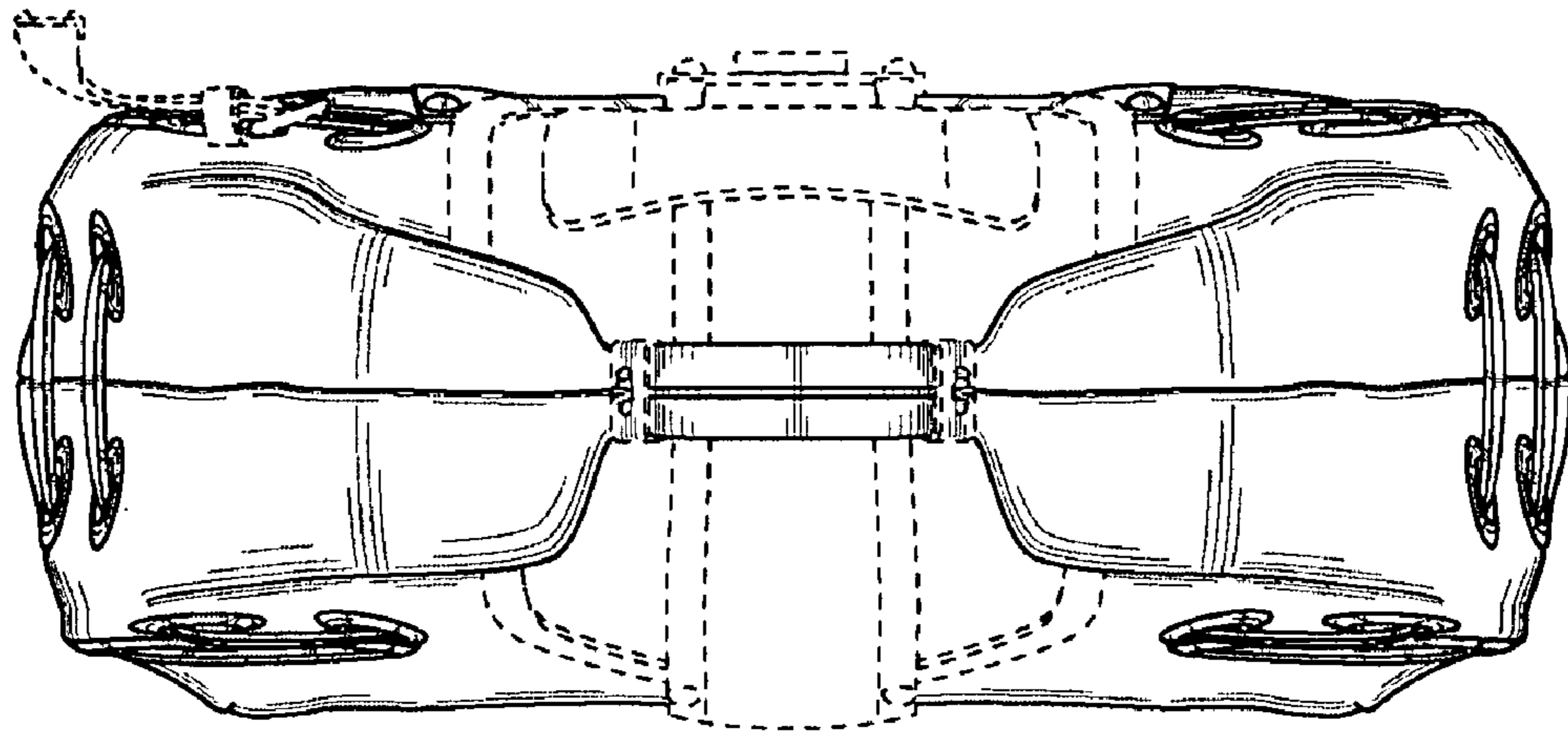

FIG. 6

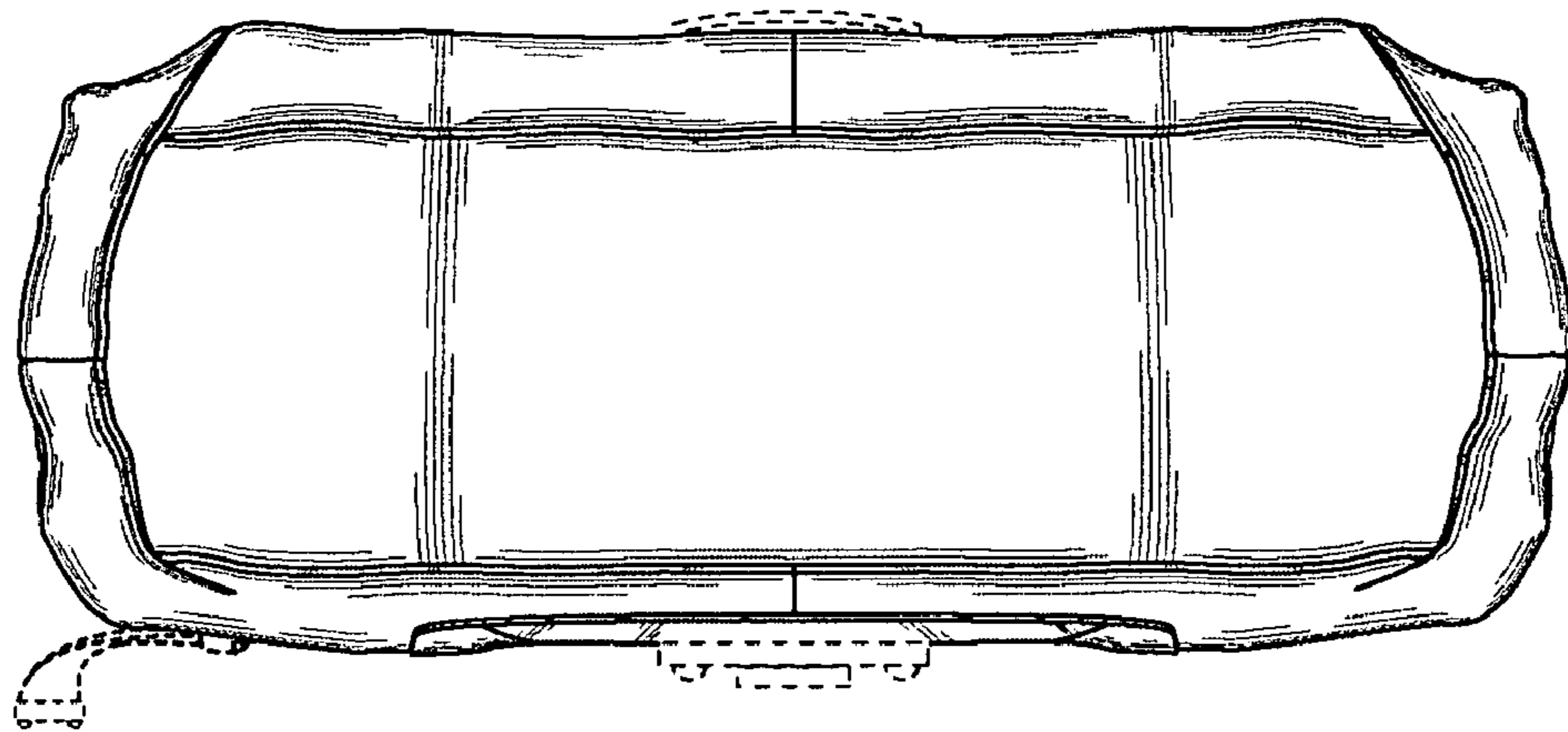

FIG. 7

UNITED STATES PATENT AND TRADEMARK OFFICE
CERTIFICATE OF CORRECTION

PATENT NO. : D588,358 S
APPLICATION NO. : 29/271659
DATED : March 17, 2009
INVENTOR(S) : Alvaro Gonzalez

Page 1 of 1

It is certified that error appears in the above-identified patent and that said Letters Patent is hereby corrected as shown below:

On the face of the patent, (30) Foreign Application Priority Data is missing. This is erroneous.

The corrected face of the patent insert

--(30) Foreign Application Priority Data

July 28, 2006 (EM).....000571591-0010--

Signed and Sealed this
Fifth Day of April, 2011



David J. Kappos
Director of the United States Patent and Trademark Office