



US00D588354S

(12) **United States Design Patent**
Chamberlain

(10) **Patent No.:** **US D588,354 S**

(45) **Date of Patent:** **** *Mar. 17, 2009**

(54) **RECIPE BOX AND EASEL**

D533,596 S * 12/2006 Braddock et al. D19/88

(76) Inventor: **Joan Chamberlain**, 3200 Main St., #3.5,
Dallas, TX (US) 75226

* cited by examiner

(*) Notice: This patent is subject to a terminal disclaimer.

Primary Examiner—Catherine R Oliver
(74) *Attorney, Agent, or Firm*—Colin P. Cahoon; James R. Gourley; Carstens & Cahoon, LLP

(**) Term: **14 Years**

(57) **CLAIM**

The ornamental design for a recipe box and easel, as shown and described.

(21) Appl. No.: **29/319,133**

(22) Filed: **Jun. 4, 2008**

DESCRIPTION

Related U.S. Application Data

(63) Continuation-in-part of application No. 29/297,009,
filed on Nov. 1, 2007, now Pat. No. Des. 581,150.

FIG. 1 is a perspective view of the recipe box and easel of the present invention, with the easel extended;

FIG. 2 is a perspective view of the recipe box and easel of the present invention, with the easel collapsed;

(51) **LOC (9) Cl.** **03-01**

(52) **U.S. Cl.** **D3/201; D19/91**

(58) **Field of Classification Search** D3/201,
D3/276, 290; 206/213, 8, 243.8, 278.9; D19/88-91;
D6/420, 406.3, 553, 310-314, 419; 24/67.3,
24/67.5; 211/50; 248/447, 455, 460, 463,
248/464, 451-452, 450

FIG. 3 is a top elevation view of the recipe box and easel of the present invention;

FIG. 4 is a right side view of the recipe box and easel of the present invention, with the easel collapsed;

FIG. 5 is a left side view of the recipe box and easel of the present invention, with the easel collapsed;

FIG. 6 is a back side perspective of the recipe box and easel of the present invention, with the easel collapsed;

See application file for complete search history.

FIG. 7 is another perspective view of the recipe box and easel of the present invention with the lid opened; and,

FIG. 8 is another back side perspective view of the recipe box and easel of the present invention, with the easel extended.

(56) **References Cited**

U.S. PATENT DOCUMENTS

2,902,785 A * 9/1959 Nichols D19/91
D380,610 S * 7/1997 Corrales D3/276
D381,197 S * 7/1997 Green et al. D3/201
D388,263 S * 12/1997 Amerault D6/419

The broken lines are for illustrative purposes only and form no part of the claimed design.

1 Claim, 7 Drawing Sheets

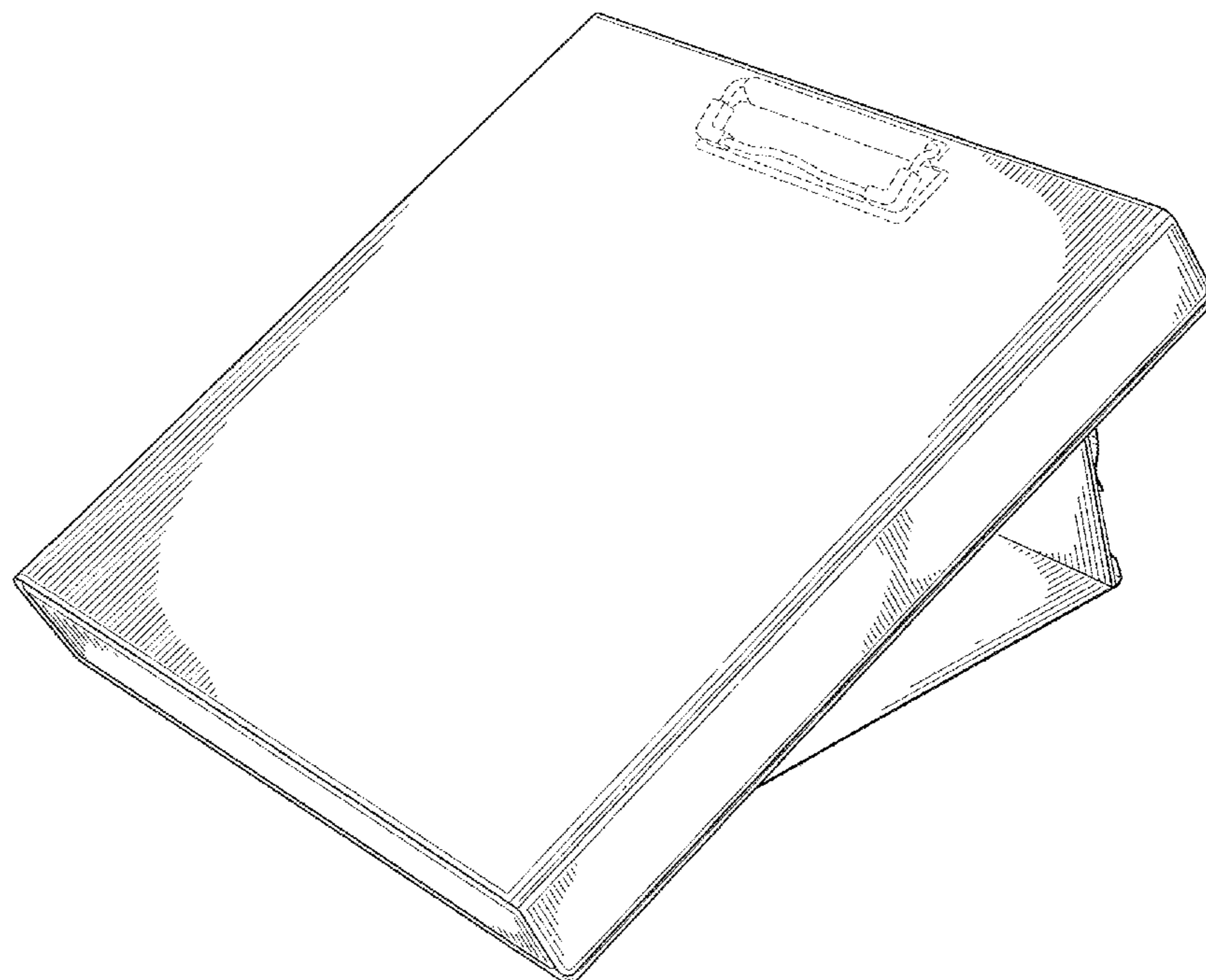

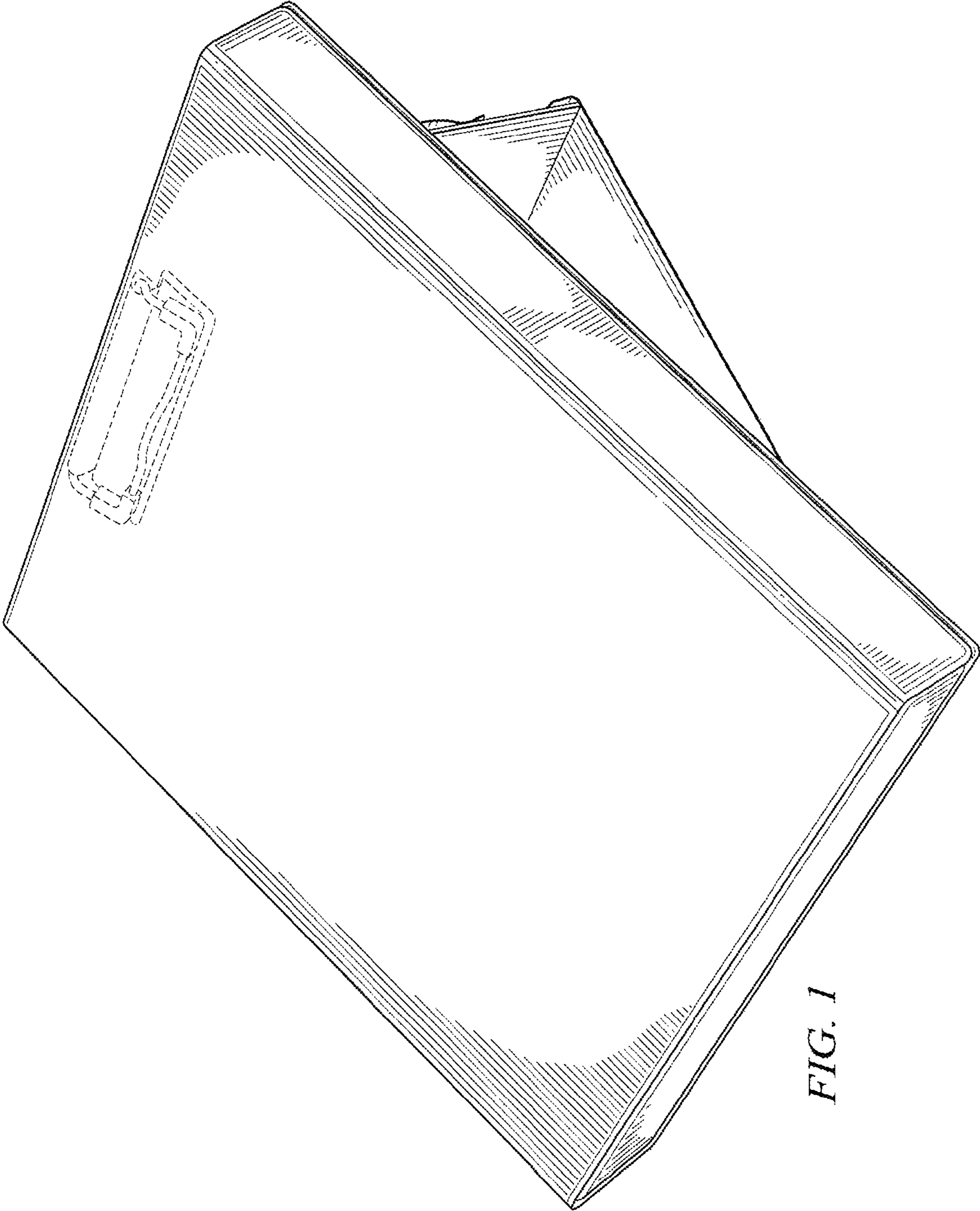

FIG. 1

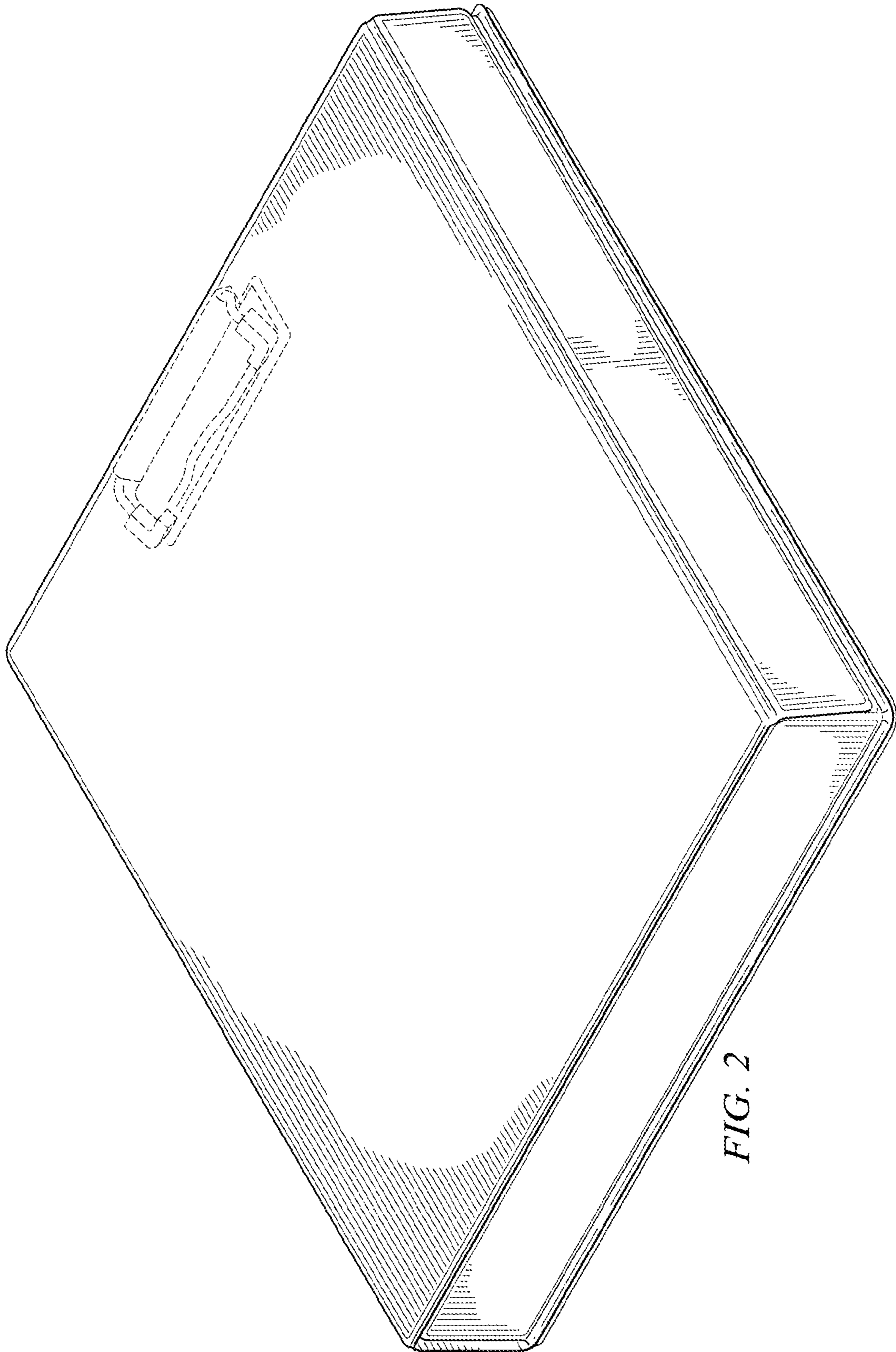

FIG. 2

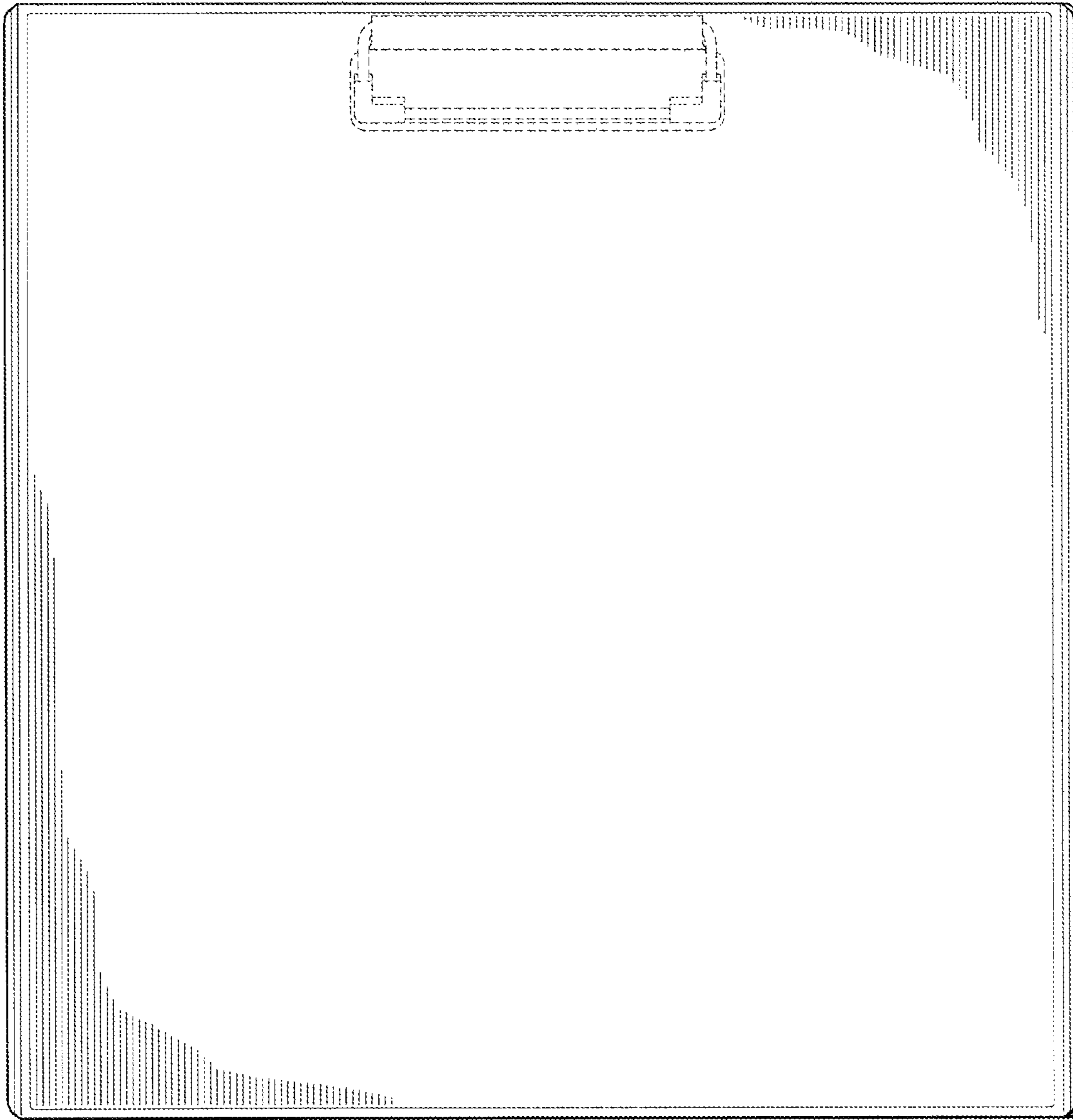

FIG. 3

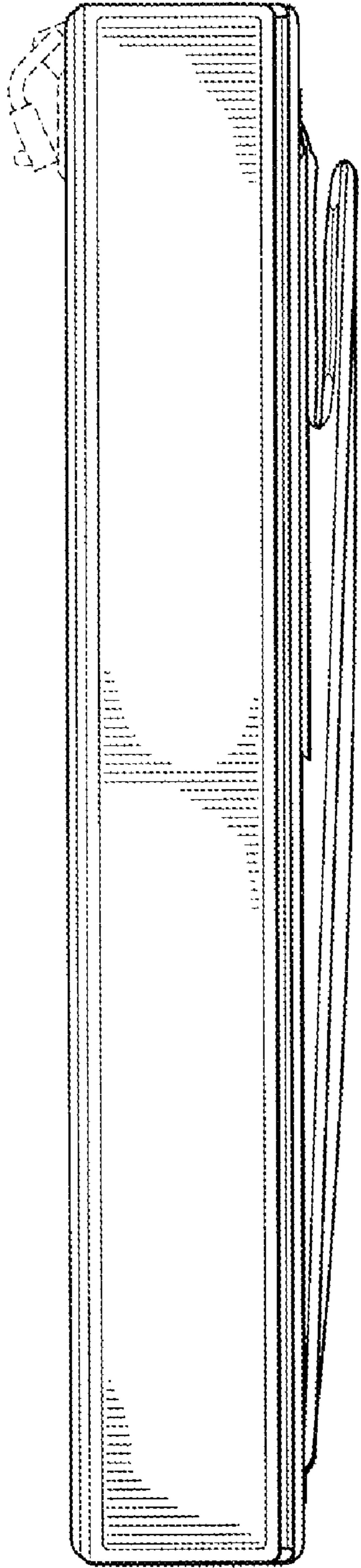

FIG. 4

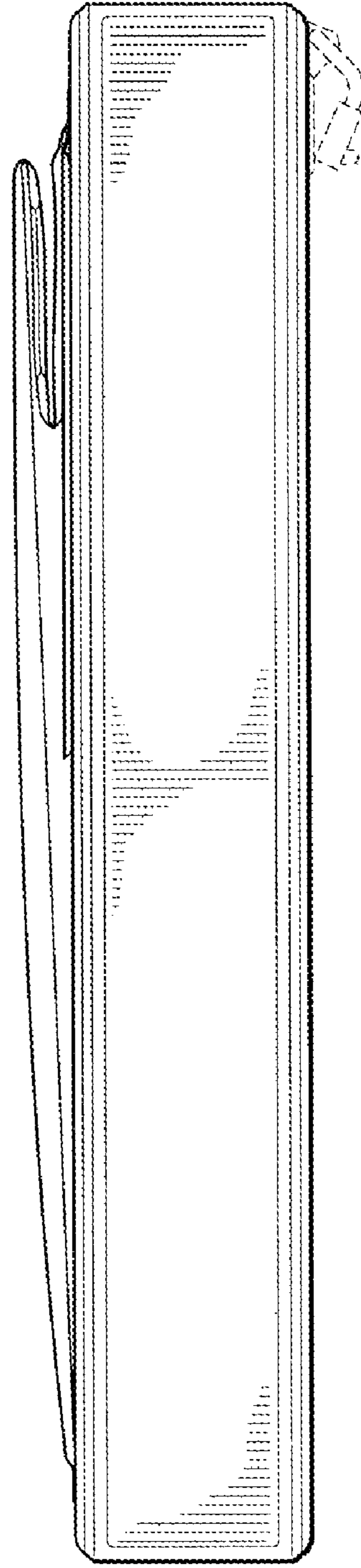

FIG. 5

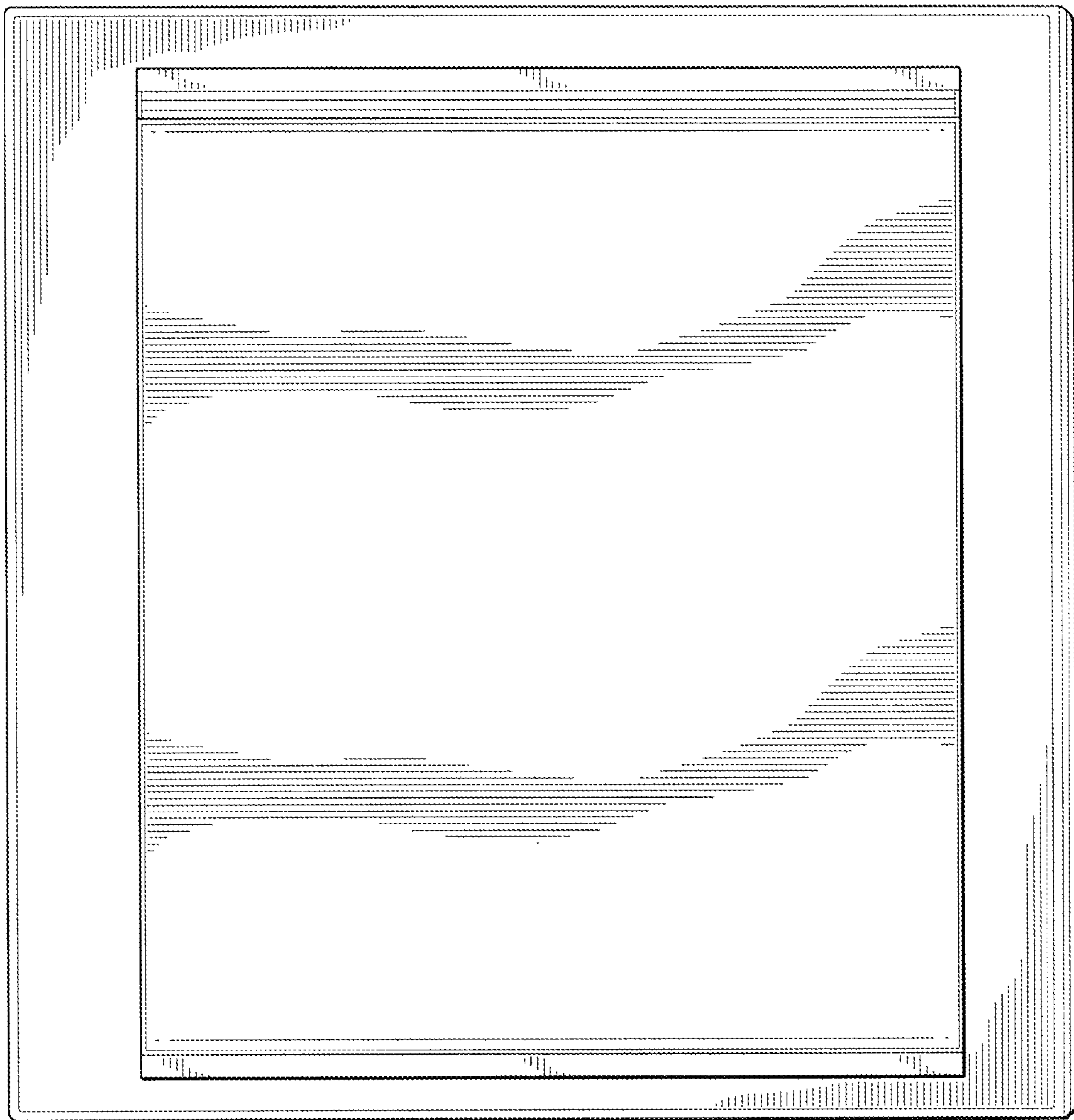

FIG. 6

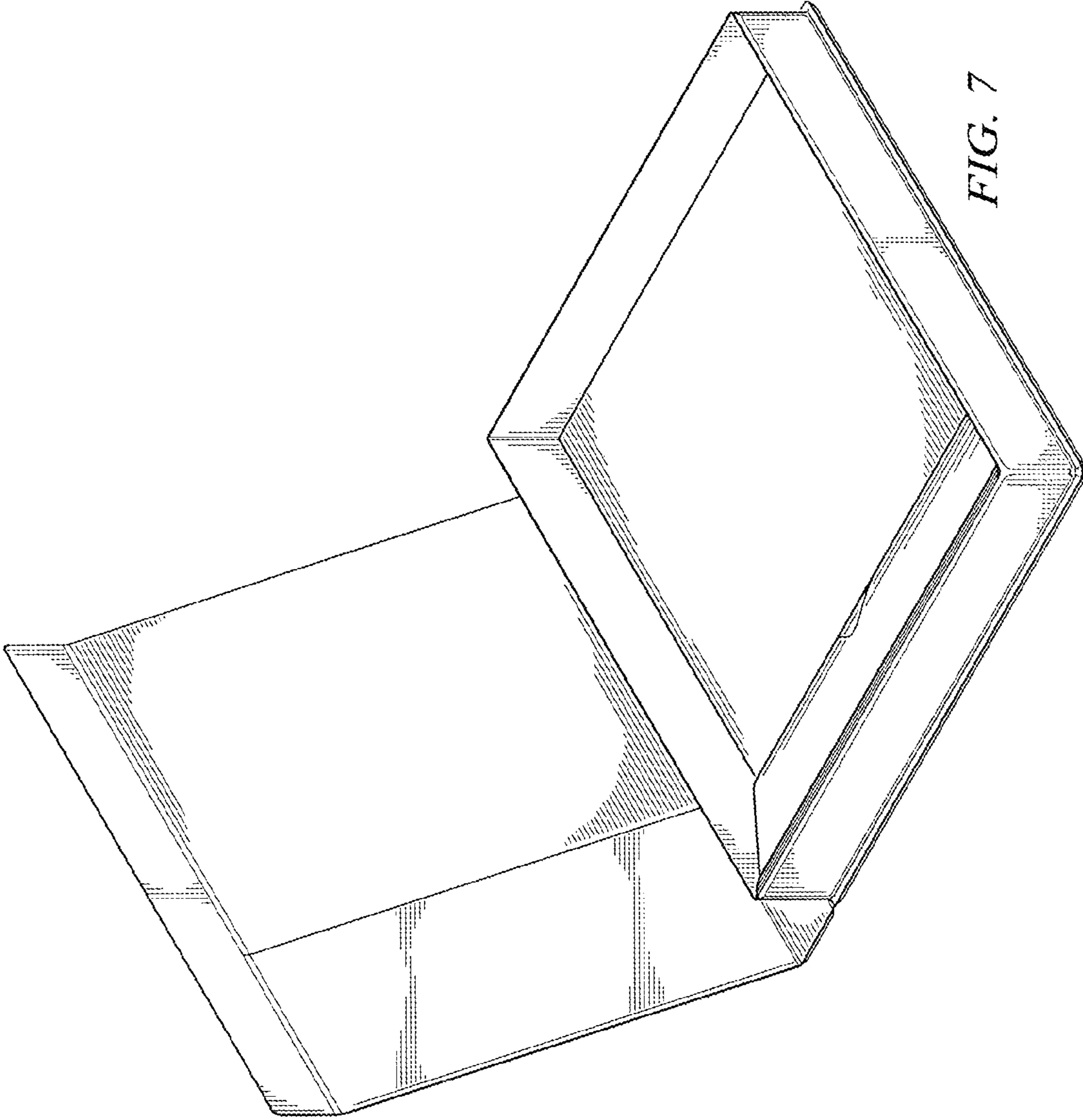

FIG. 7

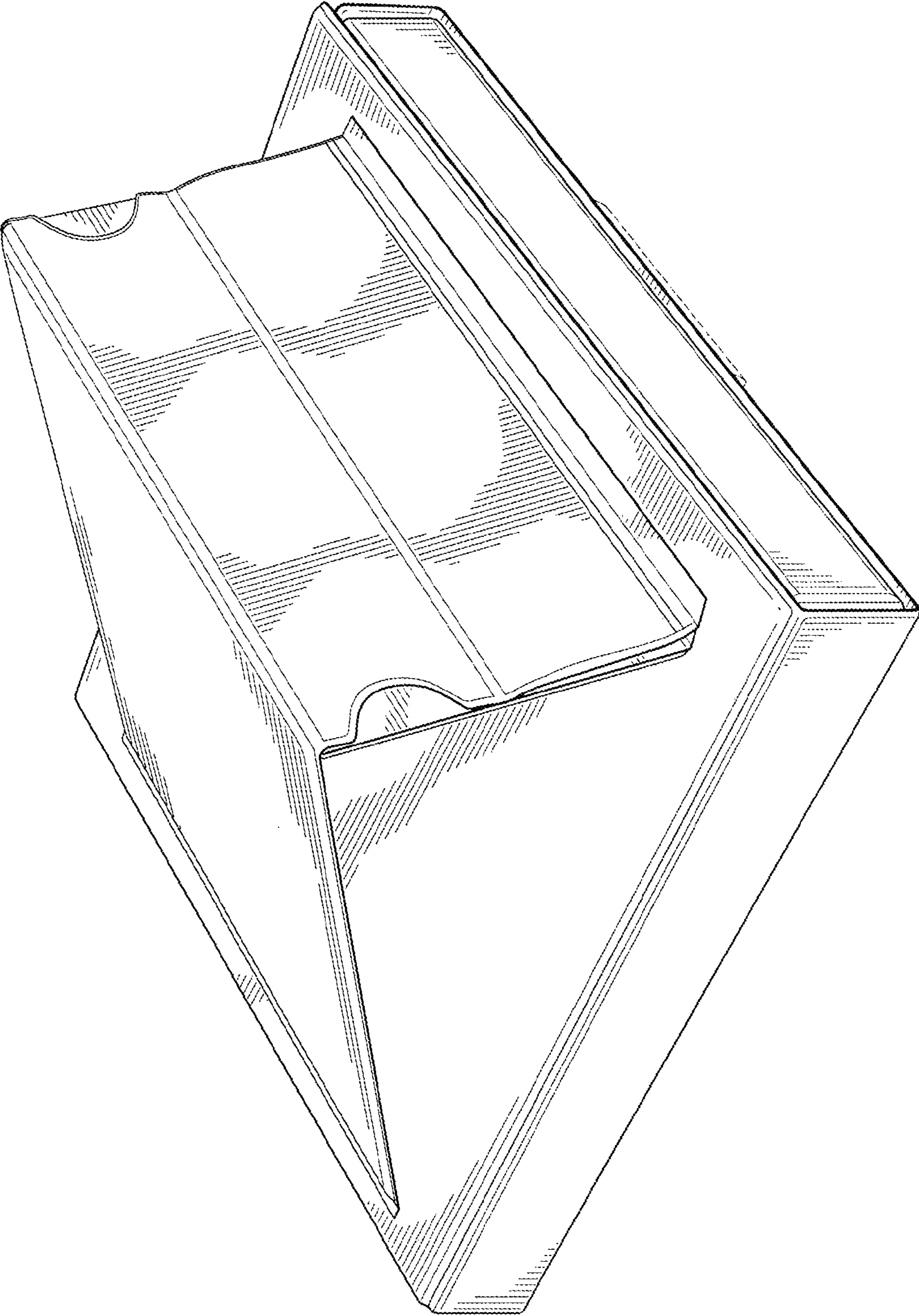

FIG. 8