



US00D588318S

(12) **United States Design Patent**
van Deursen et al.

(10) **Patent No.:** **US D588,318 S**
(45) **Date of Patent:** **** Mar. 10, 2009**

(54) **FLOOR STRIPPER**

(75) Inventors: **Gary E. van Deursen**, Essex, CT (US);
David W. Kaiser, North Haven, CT
(US); **Luke Johnson**, Seymour, CT (US)

(73) Assignee: **American Safety Razor**, Verona, VA
(US)

(**) Term: **14 Years**

(21) Appl. No.: **29/290,895**

(22) Filed: **Jan. 28, 2008**

(51) **LOC (9) Cl.** **08-05**

(52) **U.S. Cl.** **D32/49**

(58) **Field of Classification Search** D32/45,
D32/17, 51-52, 46, 48-49, 42; 401/136-140;
15/236.01, 236.04-236.07, 1.7, 244.1, 147.1,
15/228; 30/169, 171-172, 337

See application file for complete search history.

(56) **References Cited**

U.S. PATENT DOCUMENTS

812,055	A	2/1906	Linville	
839,994	A	1/1907	Hase	
851,010	A	4/1907	Kelling	
888,775	A	5/1908	Ackermann	
890,849	A	6/1908	Dosch	
903,868	A	11/1908	Kepplinger	
917,890	A	4/1909	Peltier	
953,098	A	3/1910	Mowry et al.	
989,726	A	4/1911	Rudd	
999,051	A	7/1911	McCurdy	
1,079,587	A	11/1913	Anthony	
1,241,577	A	10/1917	Thompson	
2,535,253	A *	12/1950	Anderson	30/128
2,846,785	A	8/1958	Underwood	
2,977,130	A	3/1961	Jordan	
3,074,090	A *	1/1963	Thompson	15/93.1
3,467,405	A	9/1969	Fogg	
4,048,735	A	9/1977	Brunty	
4,549,350	A	10/1985	Patillo	

D303,027	S *	8/1989	Gray	D32/49
D364,717	S *	11/1995	Trapp	D32/42
5,915,794	A	6/1999	Neff		
5,918,921	A	7/1999	Samuelson		
6,237,225	B1 *	5/2001	Tarrant	30/169
6,354,570	B1	3/2002	Christensen et al.		
D459,641	S	7/2002	Guneysu		

(Continued)

FOREIGN PATENT DOCUMENTS

CA 2141827 8/1996

(Continued)

OTHER PUBLICATIONS

“Rolling Speed Shovel” retrieved from <http://www.mysimon.com>.

(Continued)

Primary Examiner—Pamela J Burgess

(74) *Attorney, Agent, or Firm*—McDermott Will & Emery LLP

(57) **CLAIM**

The ornamental design for a floor stripper, as shown and described.

DESCRIPTION

FIG. 1 is a front perspective view of the floor stripper, showing the new design;

FIG. 2 is a front view of the floor stripper;

FIG. 3 is a rear view of the floor stripper;

FIG. 4 is a side view of the floor stripper;

FIG. 5 is another side view of the floor stripper;

FIG. 6 is a top view of the floor stripper; and,

FIG. 7 is a bottom view of the floor stripper.

The broken lines showing various elements of the floor stripper are included for the purpose of illustrating non-claimed subject matter and forms no part of the claimed design.

1 Claim, 5 Drawing Sheets

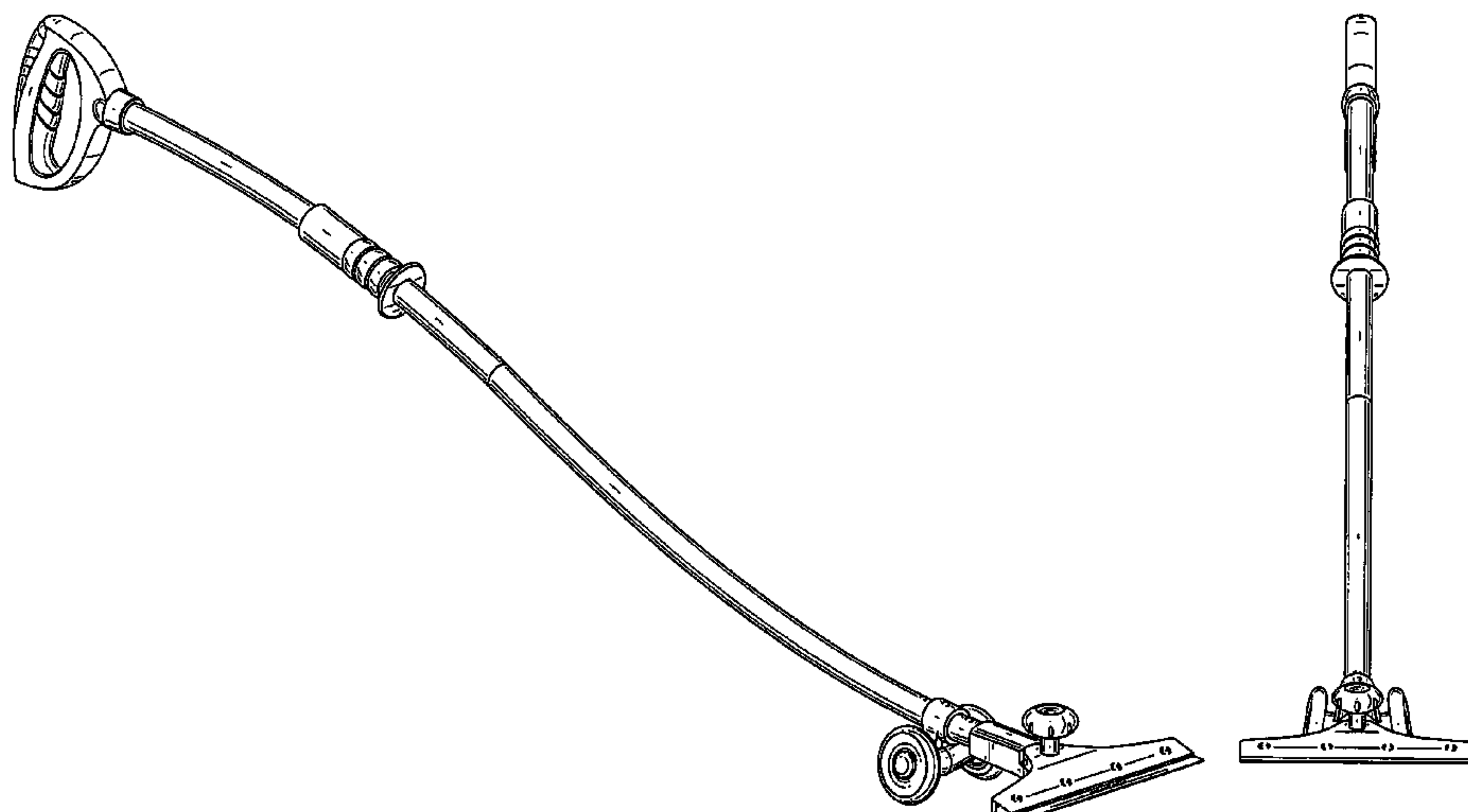

US D588,318 S

Page 2

U.S. PATENT DOCUMENTS

D485,656 S * 1/2004 Anderson et al. D32/42
D494,721 S * 8/2004 Kotani D32/50
D498,129 S 11/2004 Parker et al.
D500,239 S 12/2004 Parker et al.
6,918,321 B1 7/2005 Whittaker
D511,032 S * 10/2005 Roberts D32/41
D513,068 S * 12/2005 Blateri D23/335
7,048,804 B2 * 5/2006 Kisela et al. 134/21
D539,629 S * 4/2007 Demar et al. D8/107
7,281,288 B1 * 10/2007 McKay 15/144.2
7,293,361 B1 11/2007 Miller
D563,618 S * 3/2008 Jiang et al. D32/50
2005/0046131 A1 3/2005 Gunderson

2007/0113430 A1 5/2007 Chang
2008/0012369 A1 1/2008 Helton

FOREIGN PATENT DOCUMENTS

DE 299 19 571 U1 4/2000
DE 101 28 602 A1 1/2003
EP 0 138 571 4/1985
GB 2 277 900 A 11/1994

OTHER PUBLICATIONS

“Floor Attachments for all Industrial Vacuum Cleaning Systems
1.5"Φ and 2"Φ” retrieved from <http://www.industrial-vacuum-cleaner.com>.

* cited by examiner

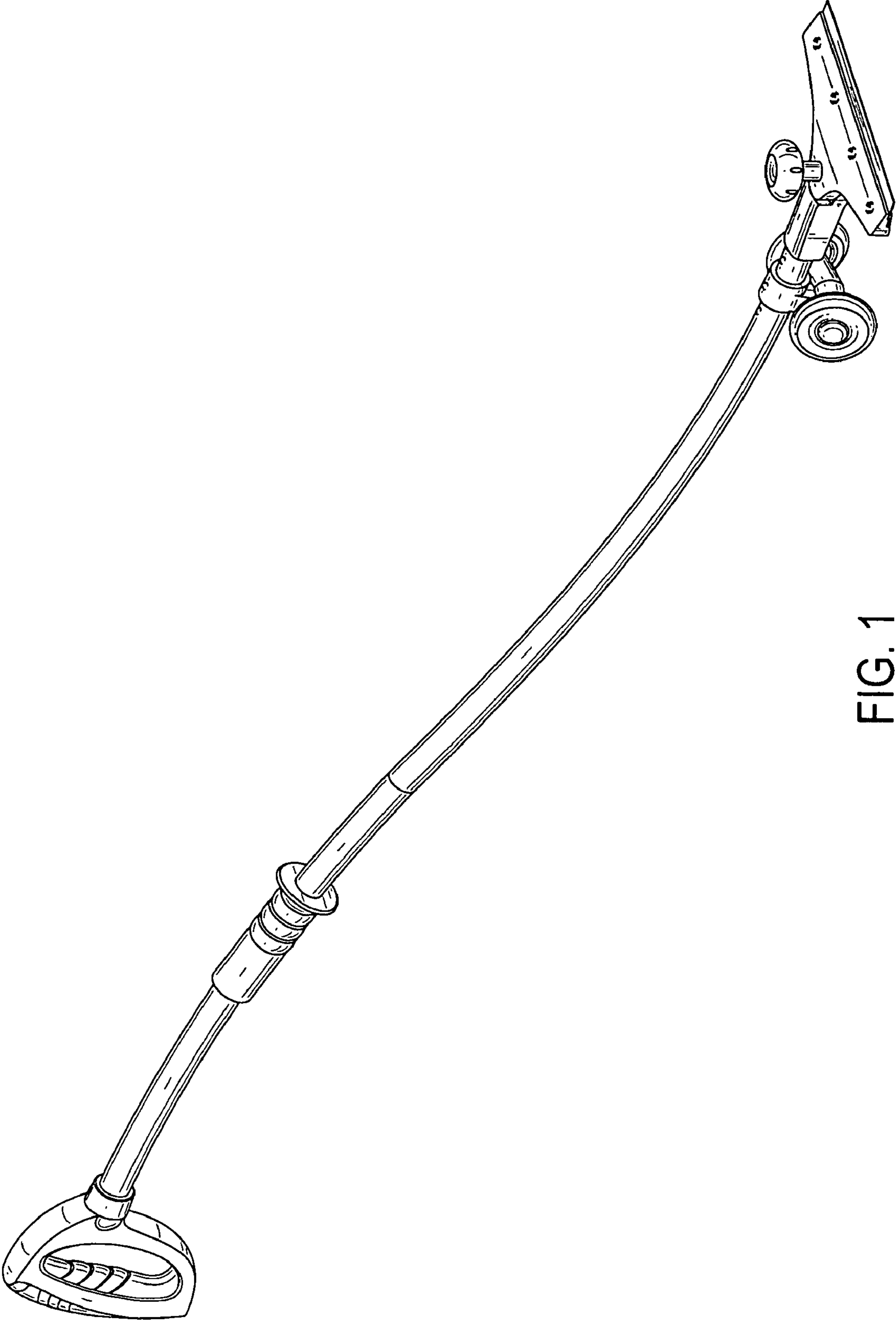

FIG. 1

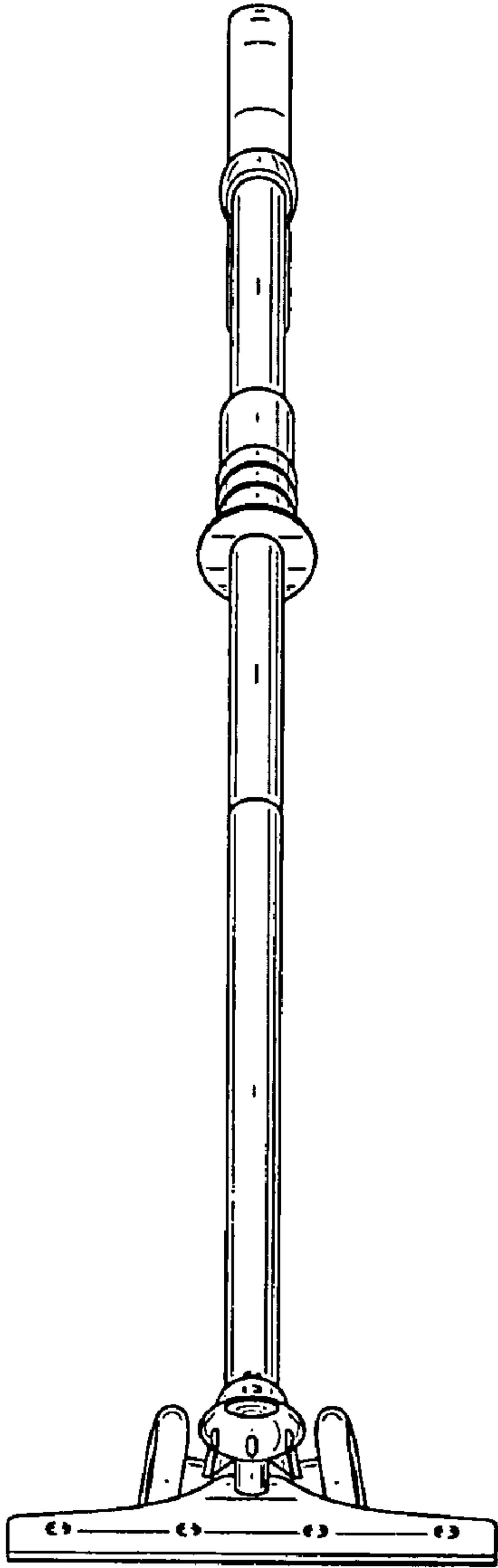

FIG. 2

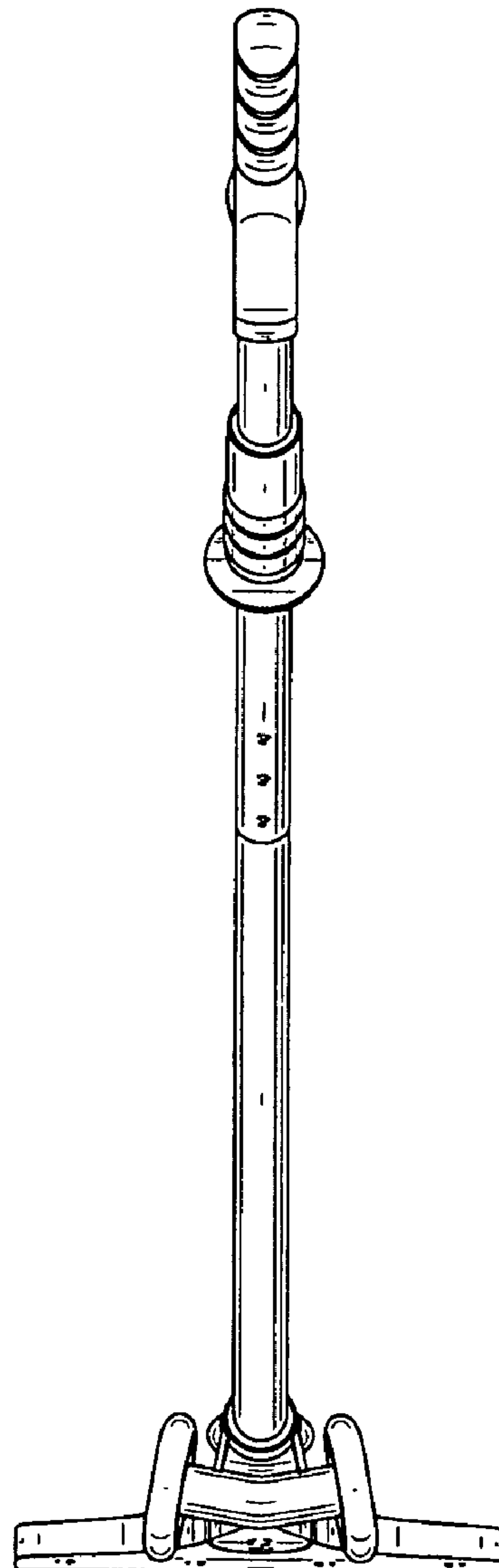

FIG. 3

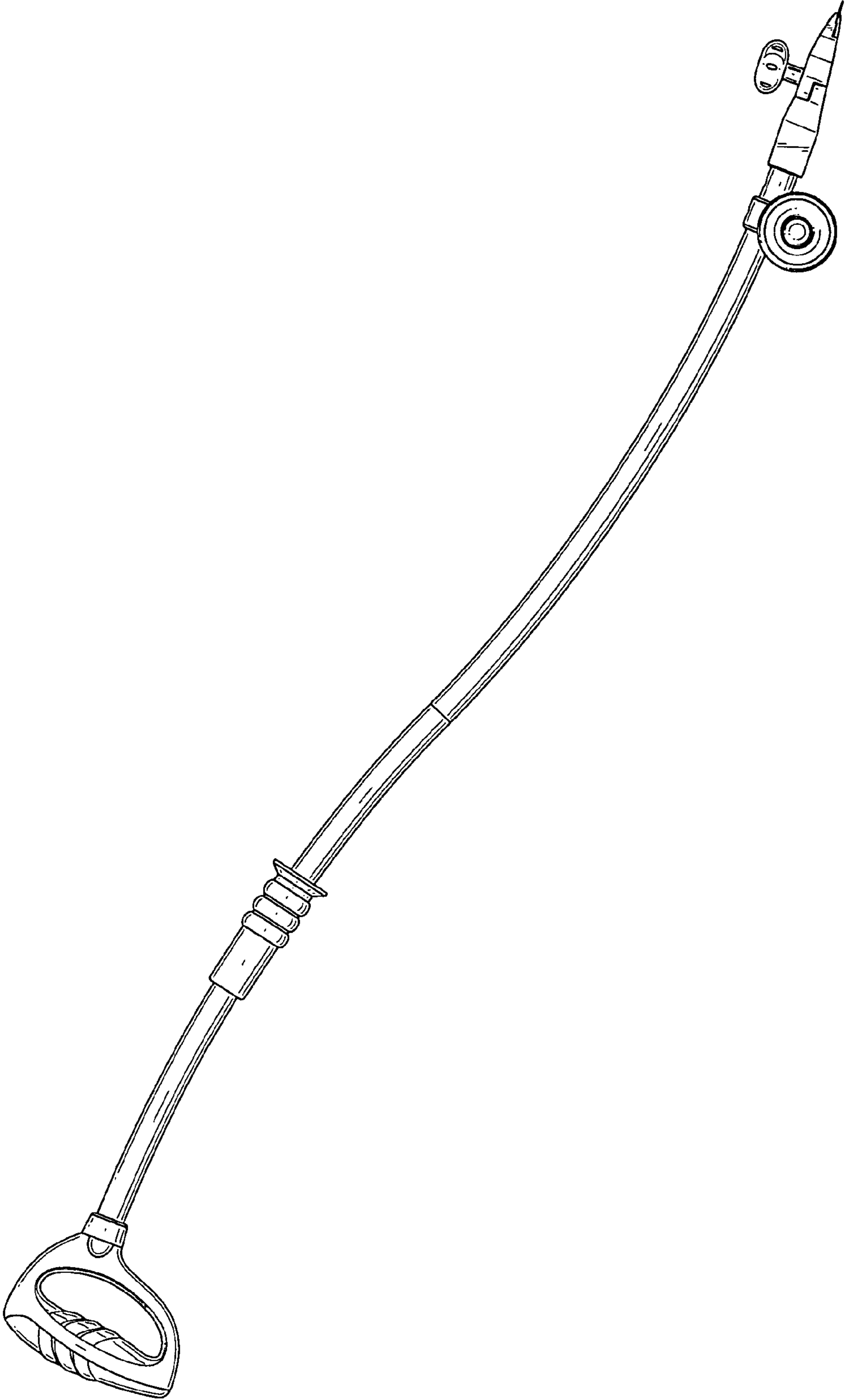

FIG. 4

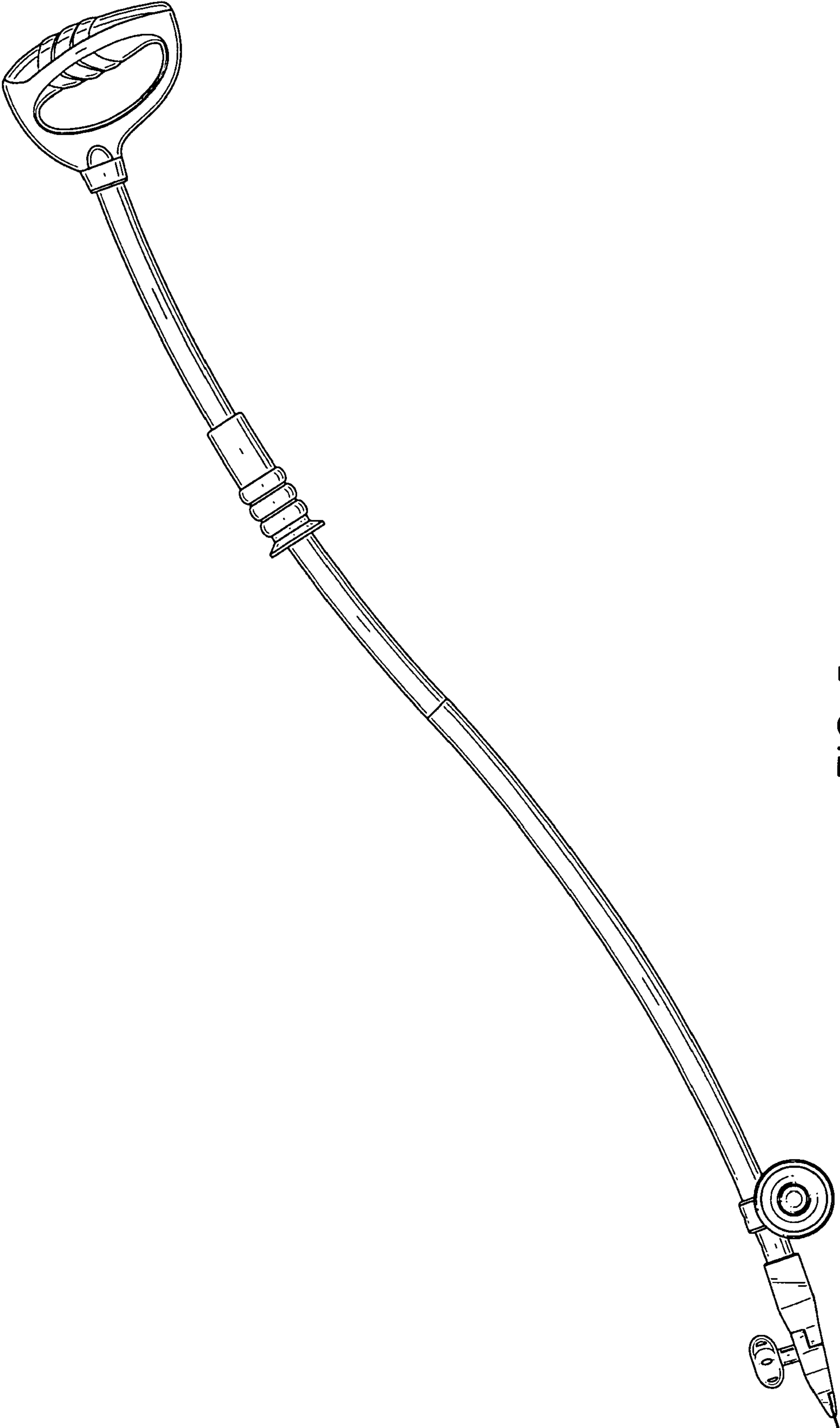

FIG. 5

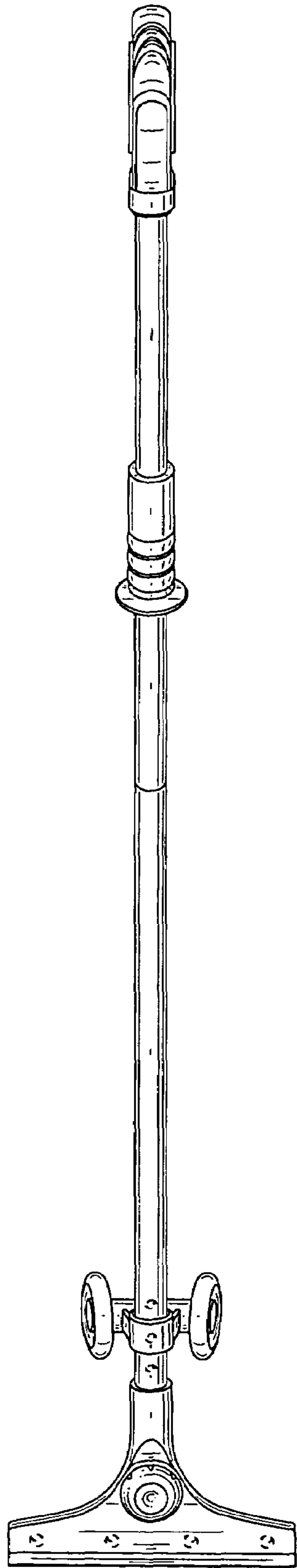

FIG. 6

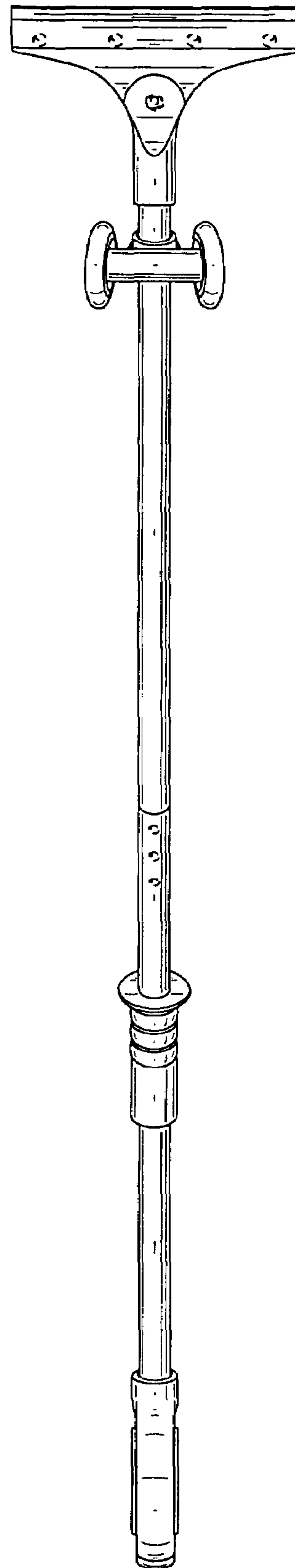

FIG. 7