



US00D588309S

(12) **United States Design Patent**  
**Wonderley**

(10) **Patent No.:** **US D588,309 S**  
(45) **Date of Patent:** **\*\* Mar. 10, 2009**

- (54) **RAZOR CARTRIDGE**
- (75) Inventor: **Jeffrey W. Wonderley**, Fort Defiance, VA (US)
- (73) Assignee: **American Safety Razor**, Verona, VA (US)
- (\*\*) Term: **14 Years**
- (21) Appl. No.: **29/300,063**
- (22) Filed: **Feb. 15, 2008**
- (51) **LOC (9) Cl.** ..... **28-03**
- (52) **U.S. Cl.** ..... **D28/47**
- (58) **Field of Classification Search** ..... D30/32, D30/34.05, 34.1-34.2, 41-41.8, 44-45, 48-50, D30/526-533, 77-83, 346-346.61; D28/44, D28/45-48

- D534,686 S 1/2007 Provost et al.
- D534,688 S 1/2007 Provost et al.
- D535,784 S \* 1/2007 Wonderley et al. .... D28/47
- 7,168,173 B2 1/2007 Worrick, III
- 7,191,523 B2 3/2007 Miyazaki et al.
- 7,197,825 B2 4/2007 Walker et al.
- 7,210,229 B2 5/2007 Coffin
- D575,454 S \* 8/2008 Keene et al. .... D28/47
- 2004/0055156 A1 3/2004 Brown, Jr.
- 2005/0022386 A1 2/2005 Macove
- 2005/0198829 A1 9/2005 Gray et al.
- 2005/0198830 A1 9/2005 Walker et al.
- 2005/0198837 A1 9/2005 Rawle et al.
- 2005/0198839 A1 9/2005 Walker
- 2006/0162167 A1 7/2006 Walker
- 2006/0196054 A1 9/2006 Luxton
- 2007/0062044 A1 3/2007 Walker et al.

See application file for complete search history.

(56) **References Cited**  
U.S. PATENT DOCUMENTS

- 5,426,851 A 6/1995 Gilder et al.
- 5,557,851 A 9/1996 Ortiz
- 5,661,907 A 9/1997 Apprille, Jr.
- 5,689,883 A 11/1997 Ortiz et al.
- 5,784,790 A 7/1998 Carson, III et al.
- 5,787,586 A 8/1998 Apprille, Jr. et al.
- 5,813,293 A 9/1998 Apprille, Jr. et al.
- 6,029,354 A 2/2000 Apprille, Jr. et al.
- D422,751 S \* 4/2000 Gray ..... D28/47
- 6,112,412 A 9/2000 Richard
- 6,131,287 A 10/2000 Prochaska et al.
- 6,138,361 A 10/2000 Richard et al.
- 6,167,625 B1 1/2001 King et al.
- 6,182,366 B1 2/2001 Richard
- 6,192,586 B1 2/2001 Metcalf et al.
- 6,212,777 B1 4/2001 Gilder et al.
- 6,216,349 B1 4/2001 Gilder et al.
- 6,276,061 B1 8/2001 Rozenkranc
- 6,941,659 B2 9/2005 Gilder
- 7,047,646 B2 5/2006 Coffin
- D526,089 S \* 8/2006 Fischer et al. .... D28/47
- 7,131,202 B2 11/2006 Pennell et al.
- D533,684 S 12/2006 Gray et al.
- D534,313 S 12/2006 Provost et al.
- D534,315 S 12/2006 Provost et al.

FOREIGN PATENT DOCUMENTS

- EP 0 578 658 B1 1/1994
- WO WO 2005/090018 A1 9/2005
- WO WO 2005/090019 A1 9/2005

\* cited by examiner

*Primary Examiner*—Jennifer Rivard  
(74) *Attorney, Agent, or Firm*—McDermott Will & Emery LLP

(57) **CLAIM**

The ornamental design for a razor cartridge, as shown and described.

**DESCRIPTION**

FIG. 1 is a front perspective view of the razor cartridge, showing the new design;  
FIG. 2 is a front view of the razor cartridge;  
FIG. 3 is a rear view of the razor cartridge;  
FIG. 4 is a side view of the razor cartridge;  
FIG. 5 is another side view of the razor cartridge;  
FIG. 6 is a top view of the razor cartridge; and,  
FIG. 7 is a bottom view of the razor cartridge.

**1 Claim, 4 Drawing Sheets**

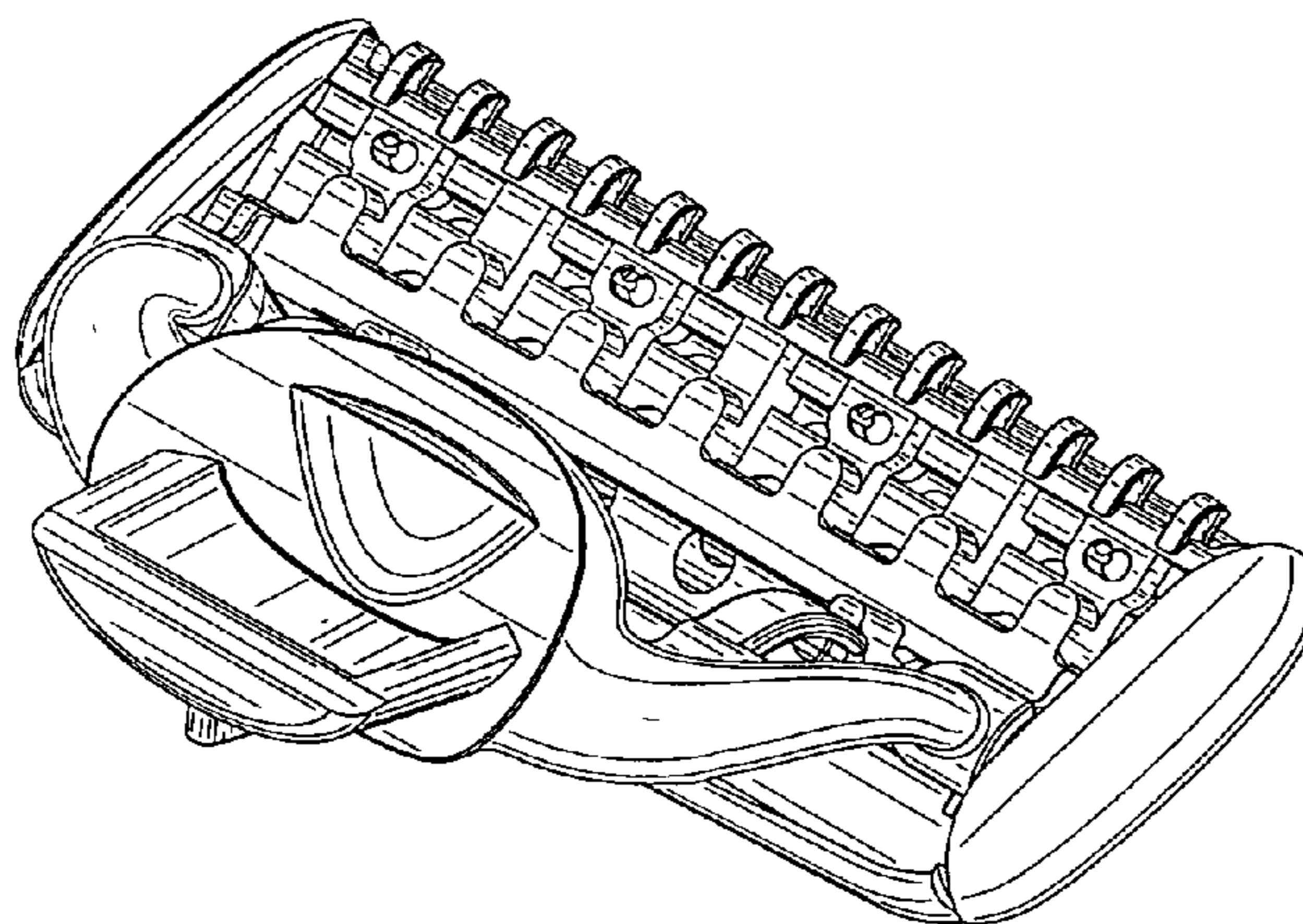

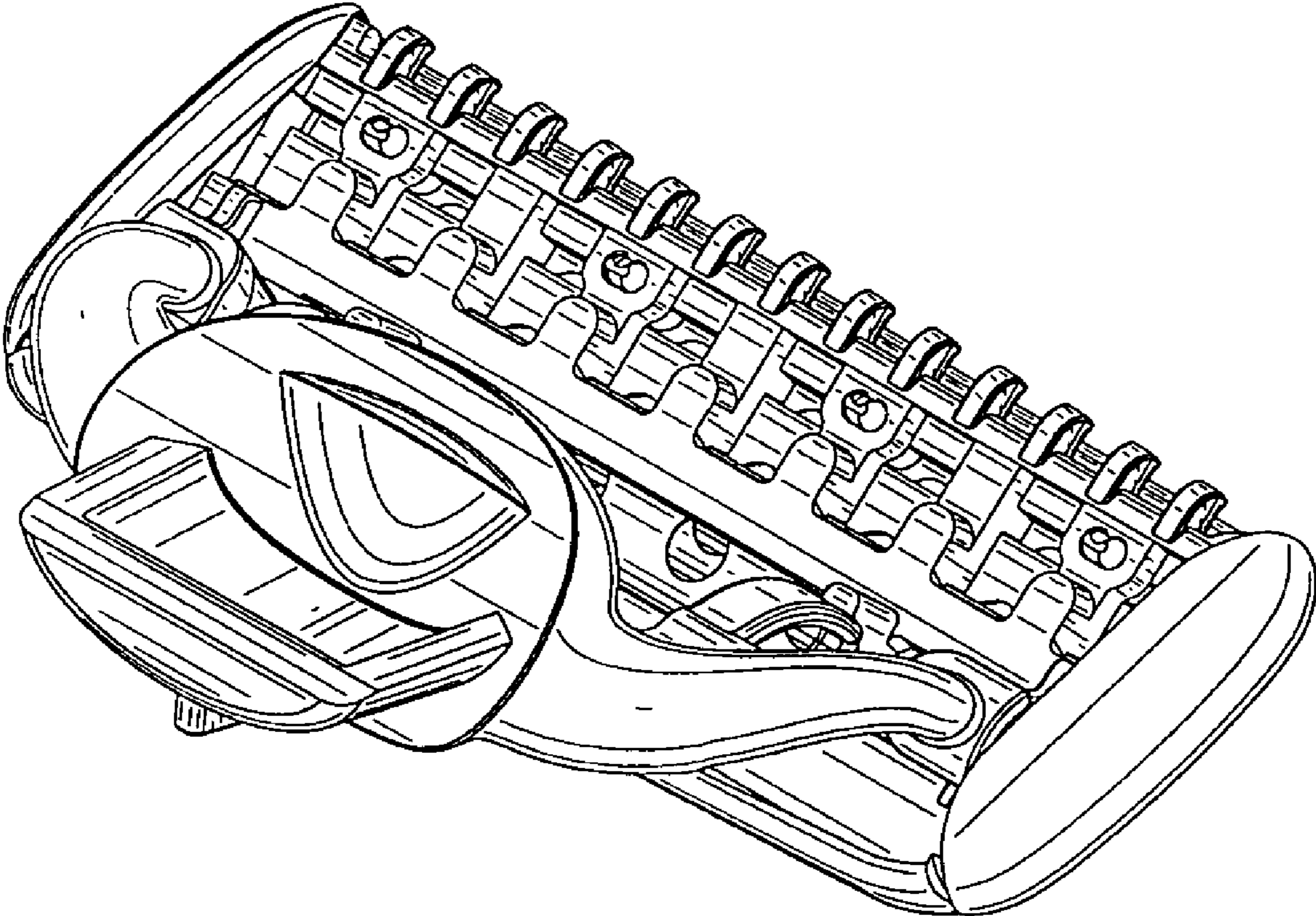

FIG. 1

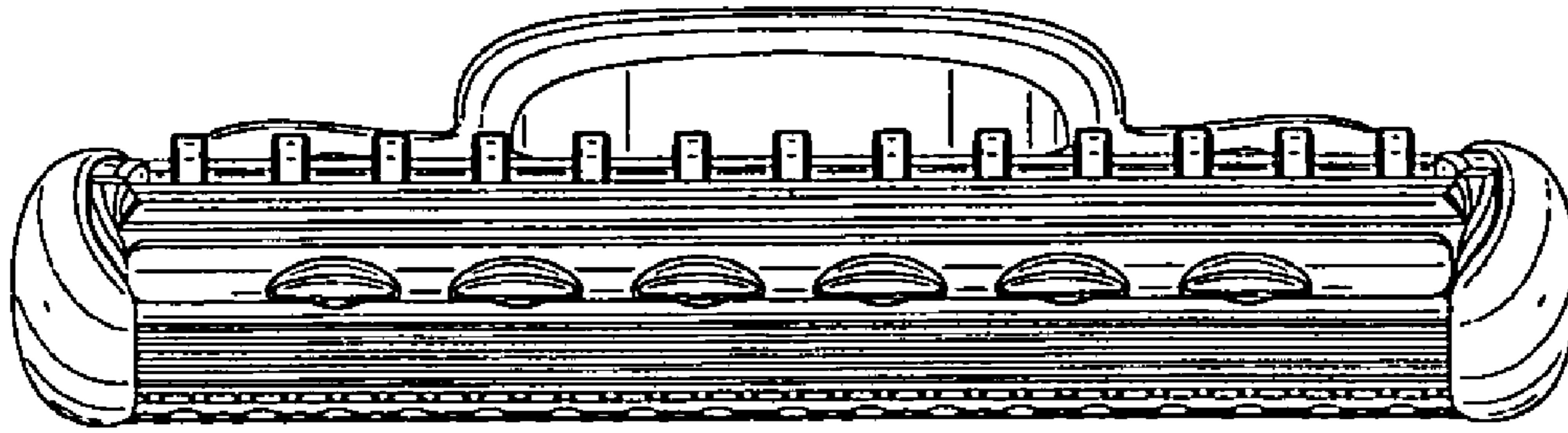

FIG. 2

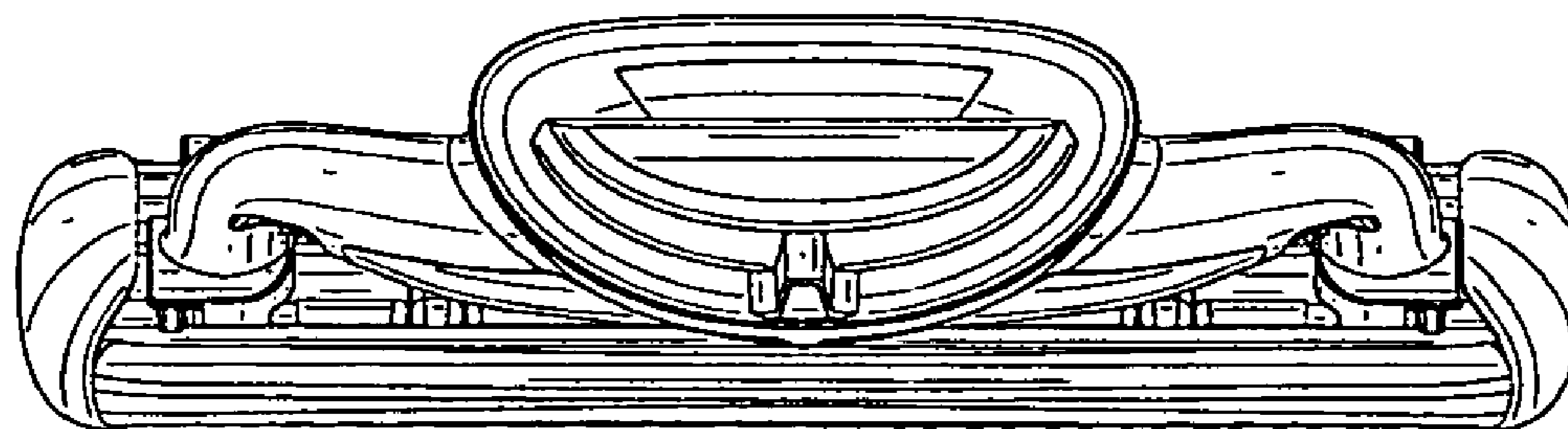

FIG. 3

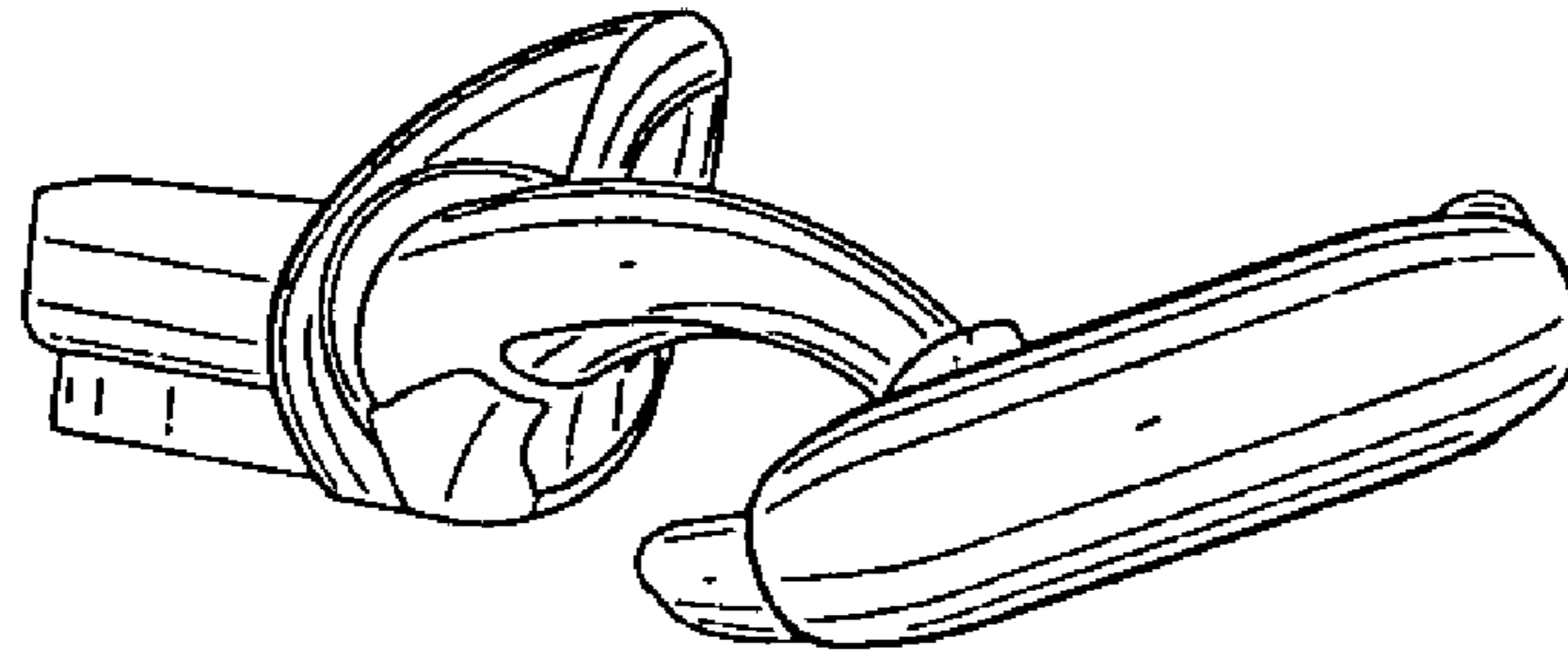

FIG. 4

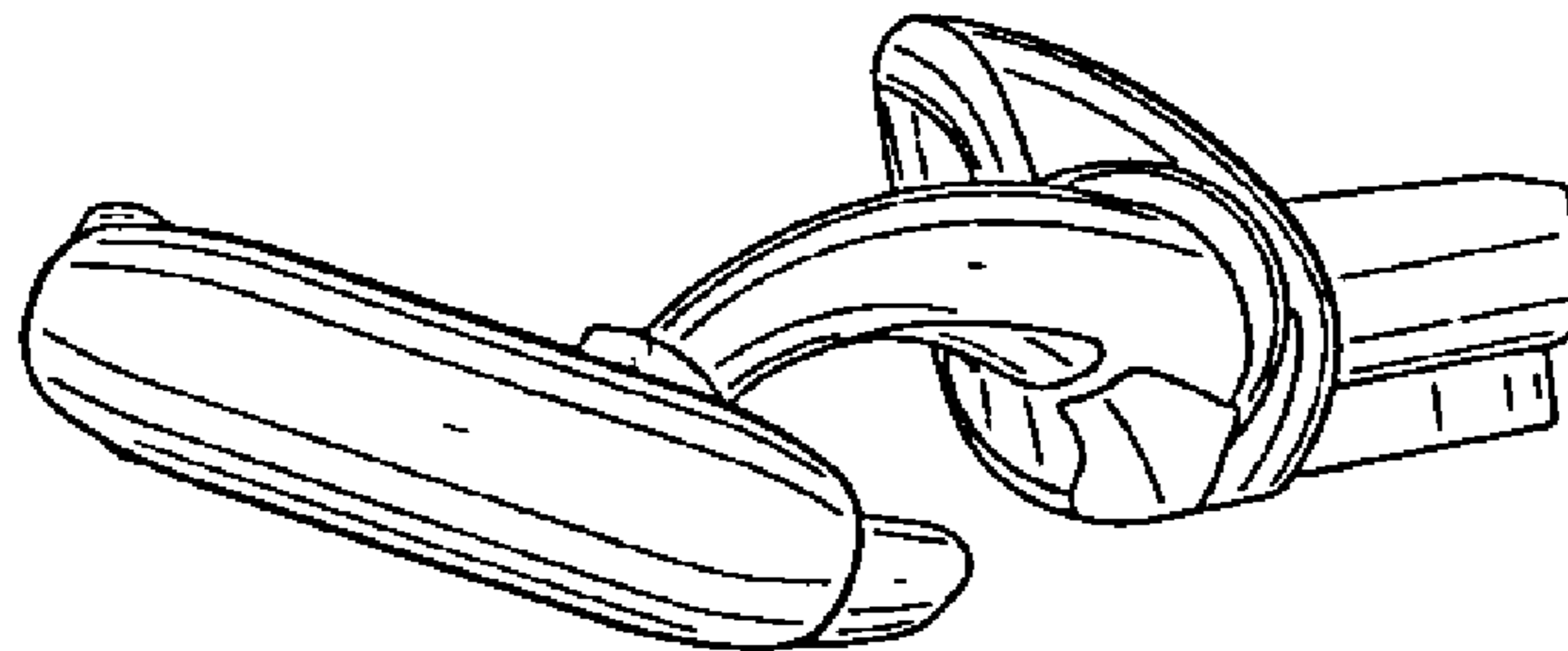

FIG. 5



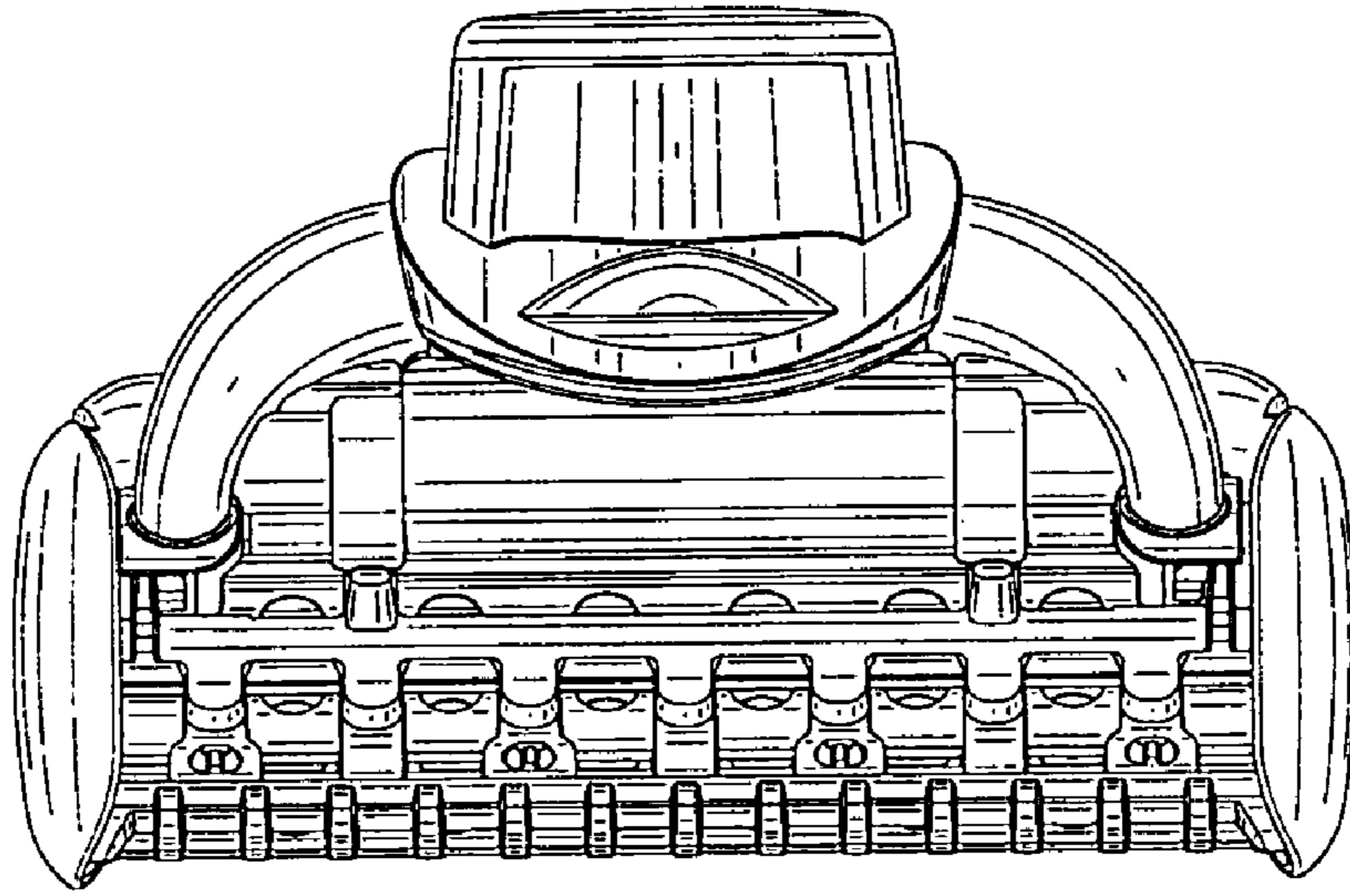

FIG. 6

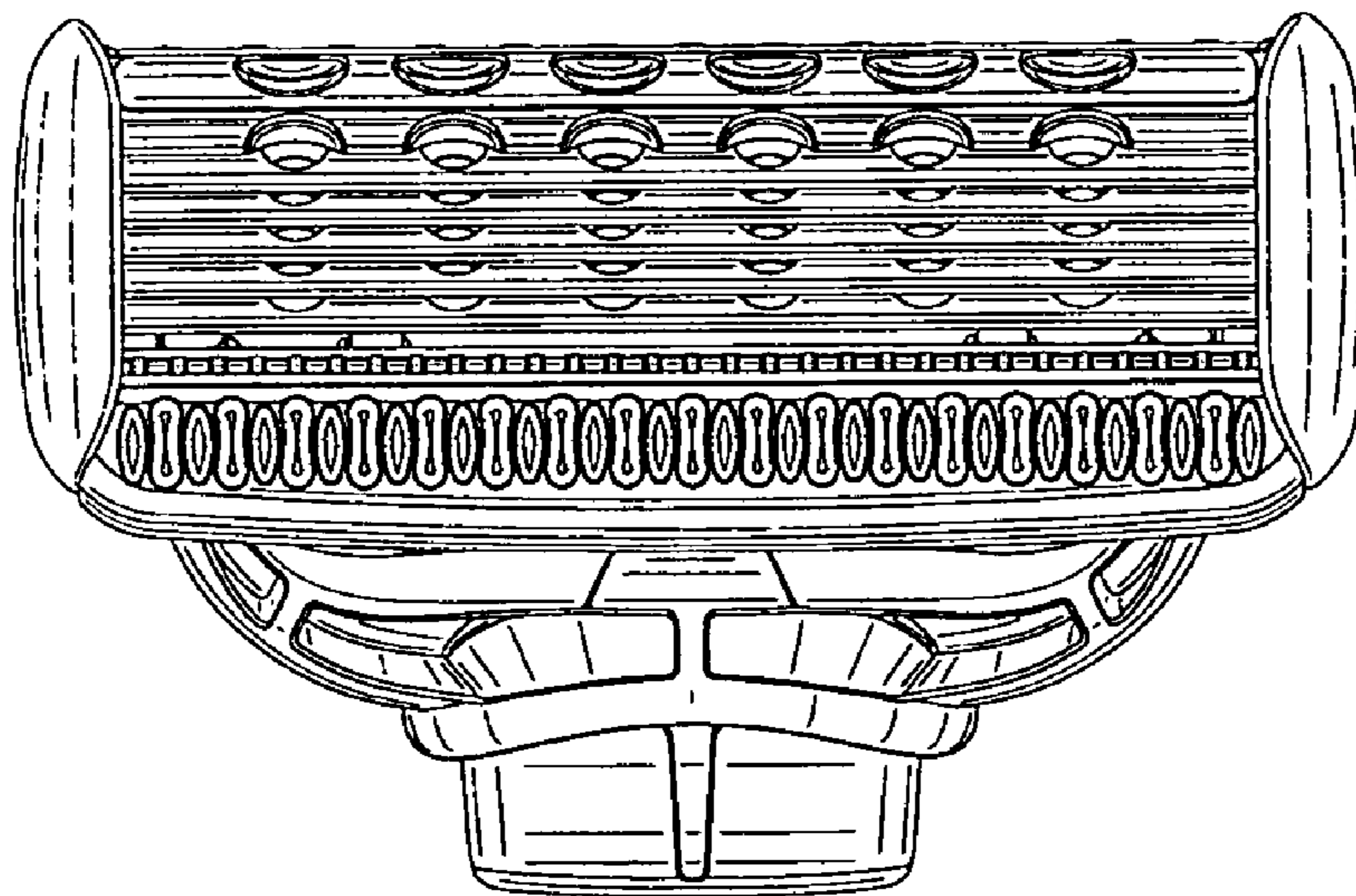

FIG. 7