



US00D588277S

(12) **United States Design Patent**
Unertl

(10) **Patent No.:** **US D588,277 S**

(45) **Date of Patent:** **** Mar. 10, 2009**

(54) **BOW BLIND**

(76) Inventor: **Russell J. Unertl**, 112 Mill St., Neosho,
WI (US) 53059

(**) Term: **14 Years**

(21) Appl. No.: **29/320,837**

(22) Filed: **Jul. 7, 2008**

(51) **LOC (9) Cl.** **25-03**

(52) **U.S. Cl.** **D25/16**

(58) **Field of Classification Search** D25/1,
D25/16; D21/834; 43/1; 135/90, 98, 117,
135/901, 908

See application file for complete search history.

(56) **References Cited**

U.S. PATENT DOCUMENTS

1,102,418	A *	7/1914	Lindsay et al.	135/90
3,874,398	A *	4/1975	Hendrickson	135/144
4,517,230	A	5/1985	Crawford		
4,637,415	A *	1/1987	Dalo et al.	135/98
5,944,041	A *	8/1999	Kitchens	135/98
6,296,415	B1 *	10/2001	Johnson et al.	403/170
D470,907	S *	2/2003	Ju	D21/834
7,275,532	B2 *	10/2007	Niemackl et al.	124/86

2007/0119441 A1* 5/2007 Niemackl et al. 124/86

* cited by examiner

Primary Examiner—T. Chase Nelson

Assistant Examiner—Kathleen M Sims

(74) *Attorney, Agent, or Firm*—Donald J. Ersler

(57) **CLAIM**

The ornamental design for a bow blind, as shown and described.

DESCRIPTION

FIG. 1 is a perspective view of a bow blind showing my new design;

FIG. 2 is a perspective view of the opposite side thereof;

FIG. 3 is a front elevation view thereof;

FIG. 4 is a rear elevation view thereof;

FIG. 5 is a top plan view thereof;

FIG. 6 is a bottom plan view thereof; and,

FIG. 7 is a right side view thereof.

The broken line showing of blind sleeves in FIGS. 2 and 3 and of a bow in FIG. 7 is included for the purpose of showing environmental portions of the bow blind and forms no part of the claimed design.

1 Claim, 6 Drawing Sheets

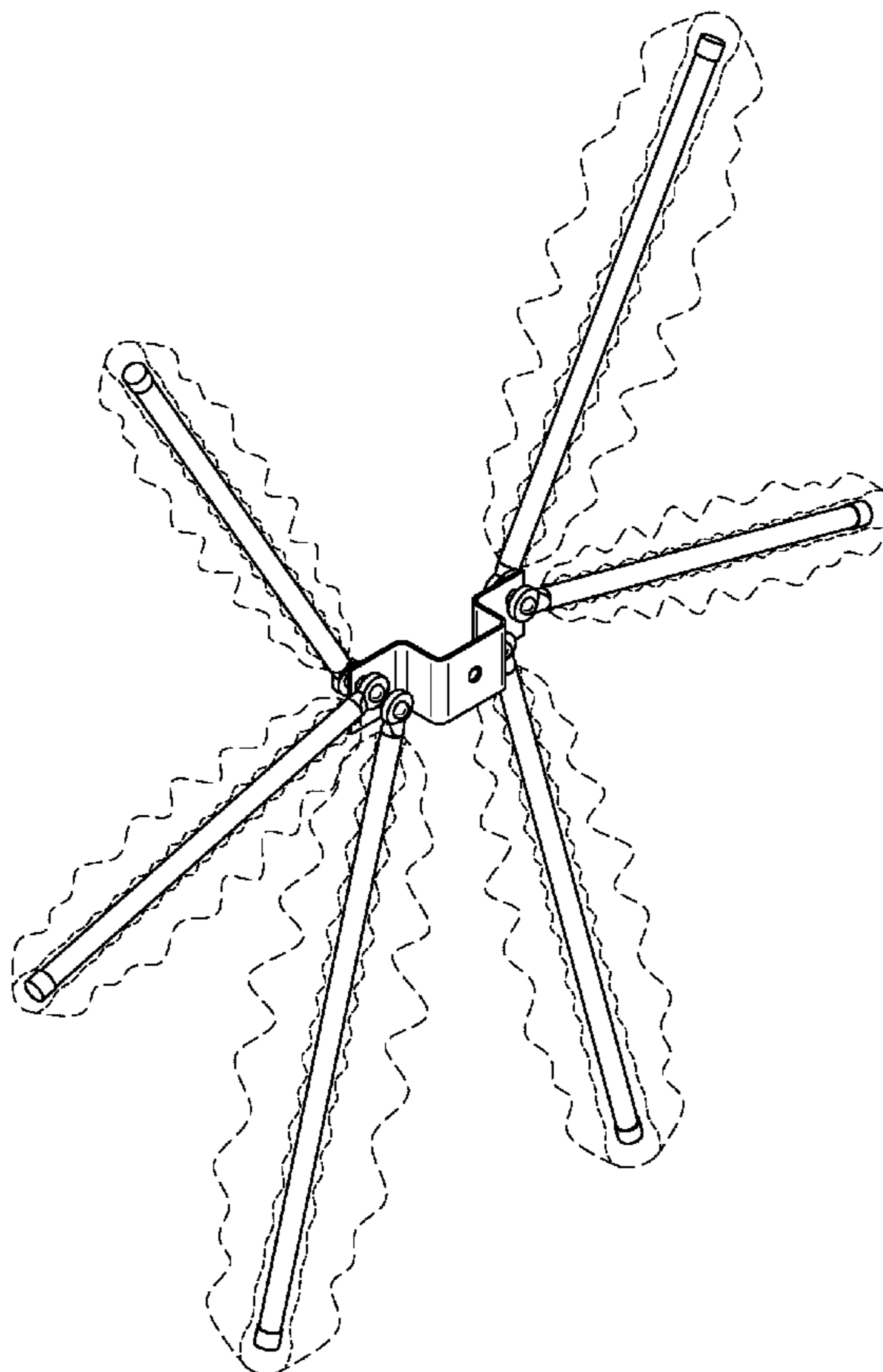

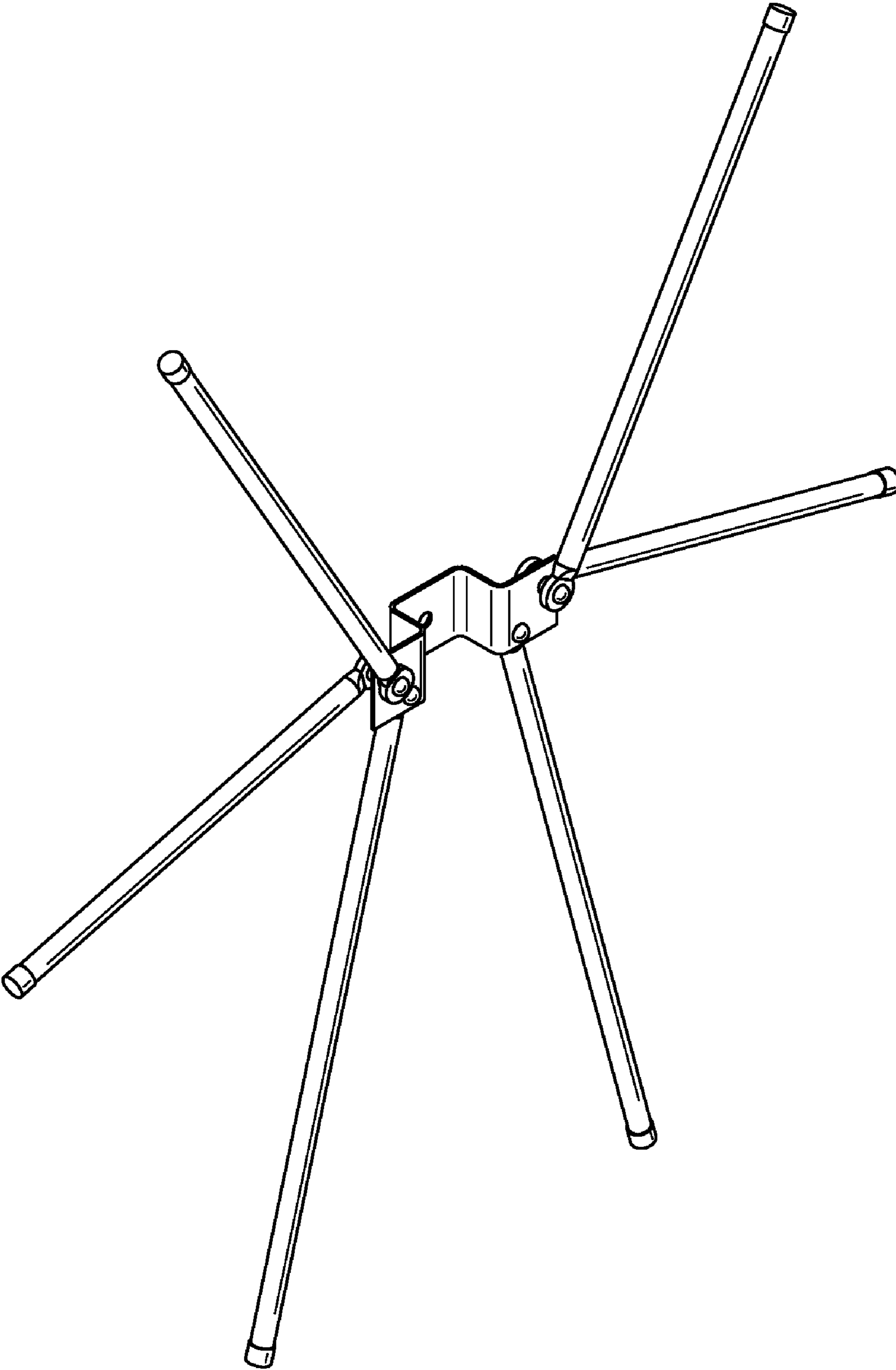

FIG. 1

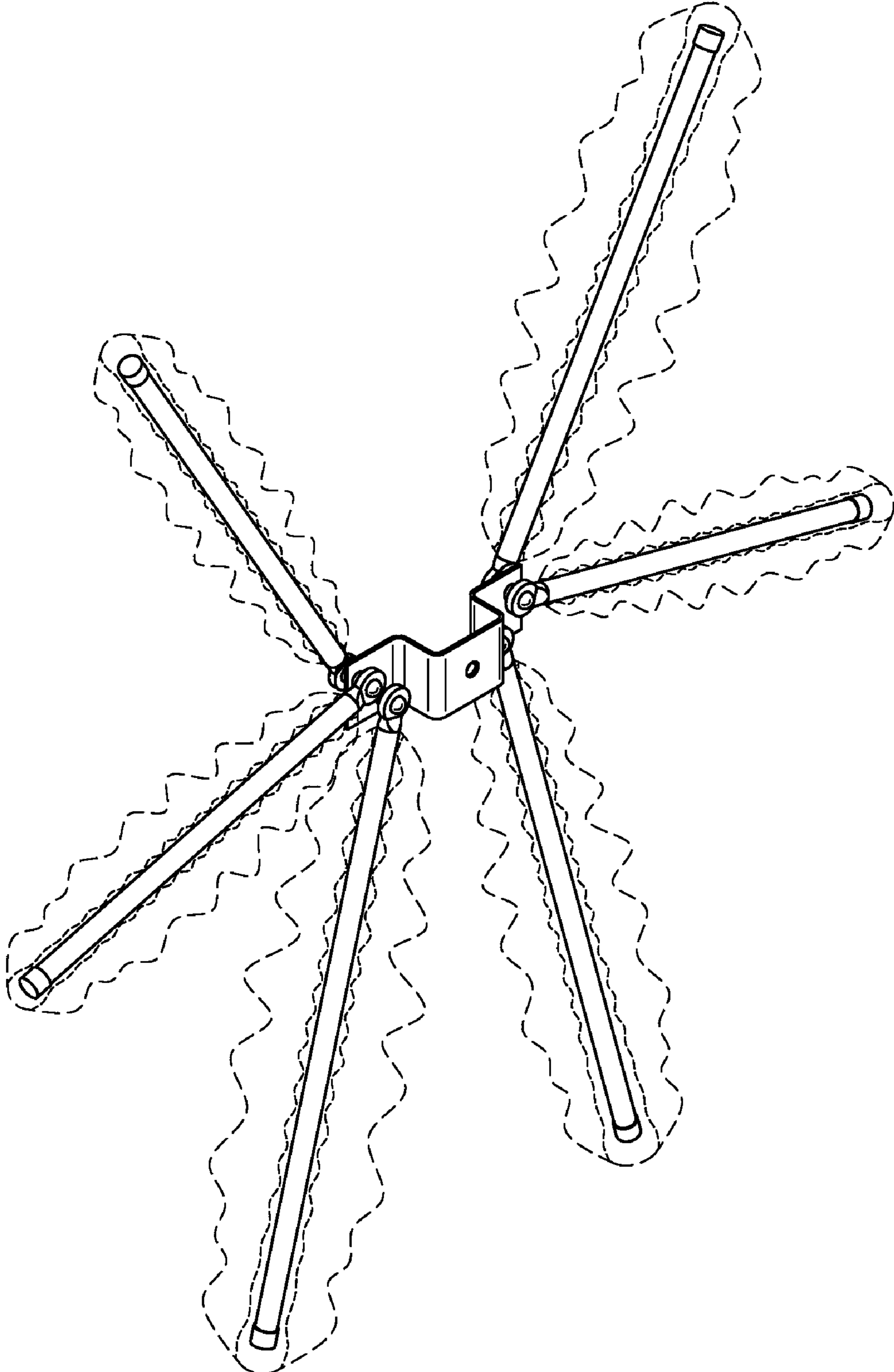

FIG. 2

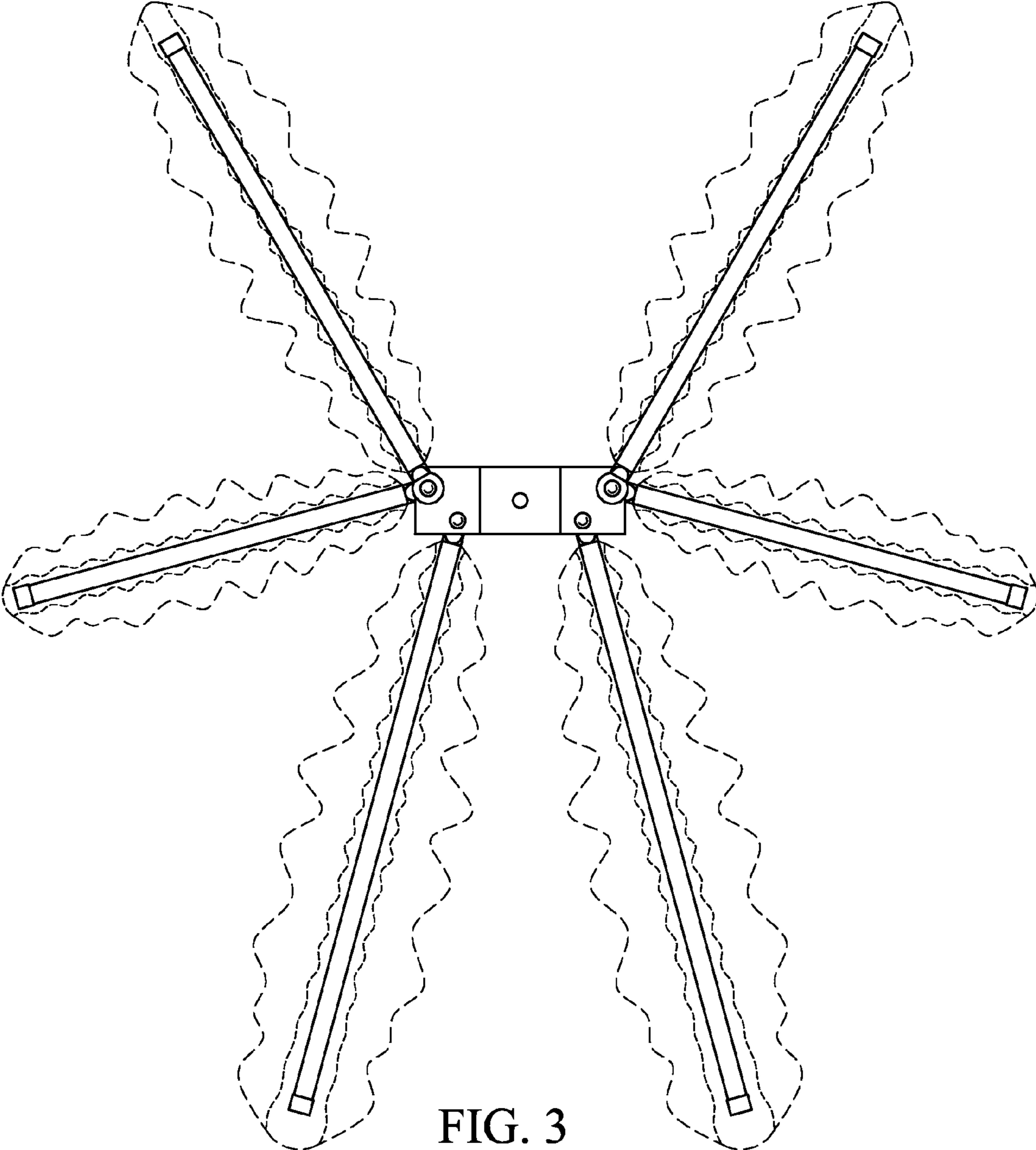

FIG. 3

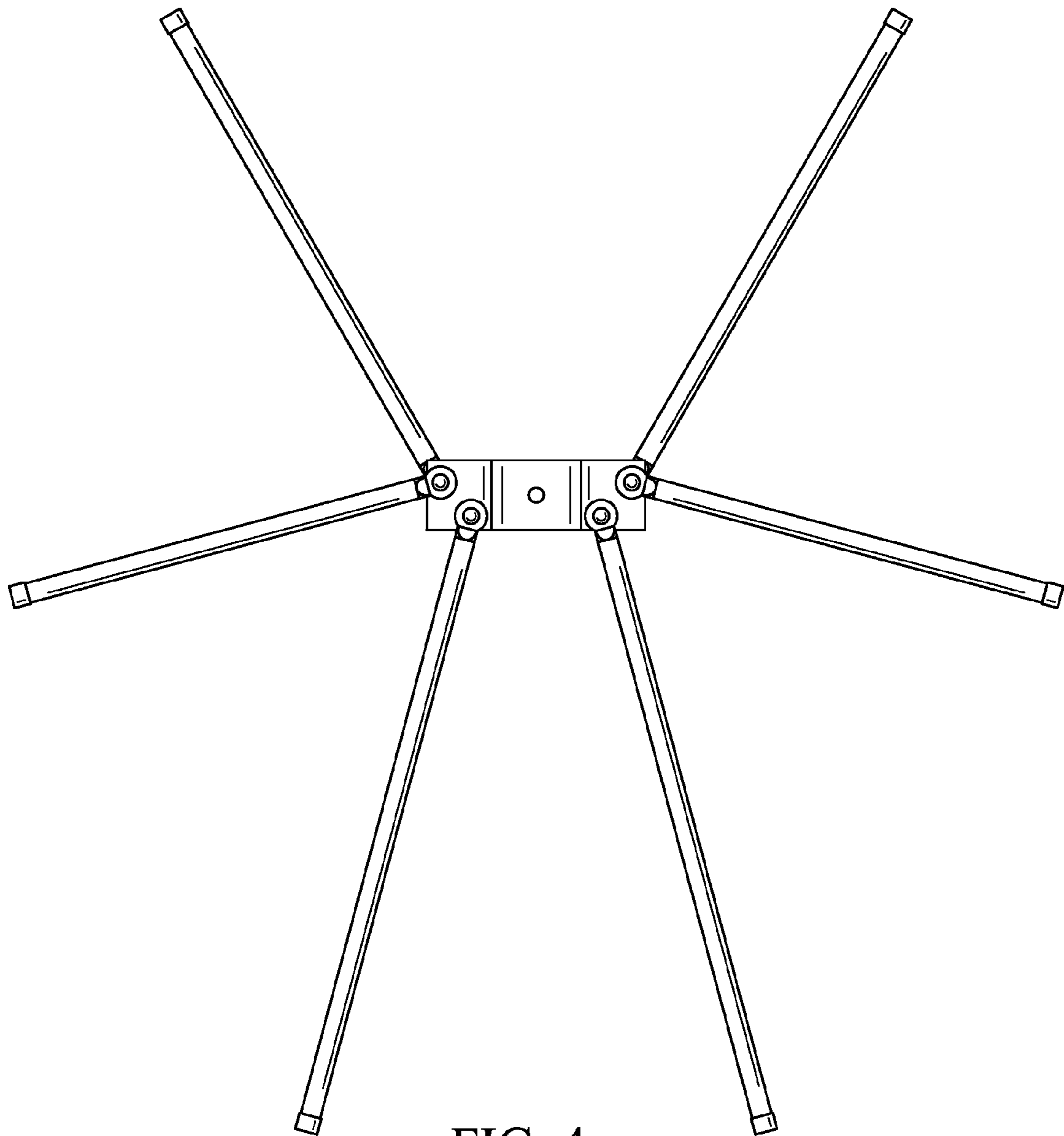

FIG. 4

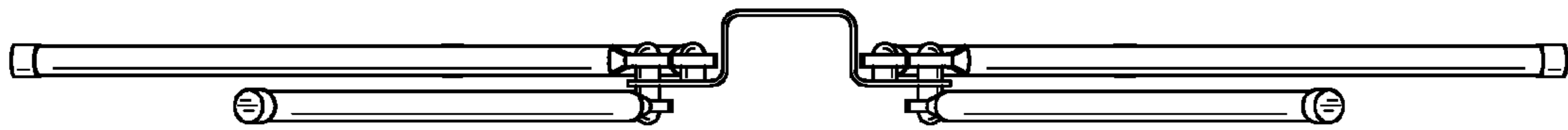

FIG. 5

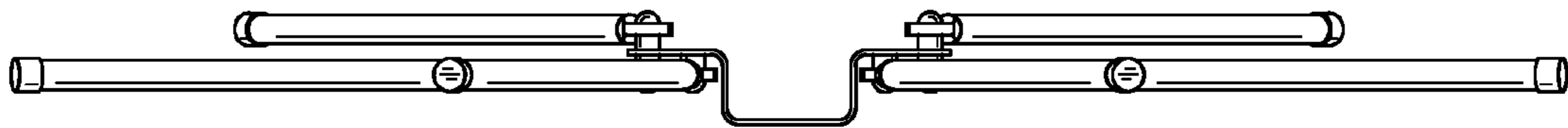

FIG. 6

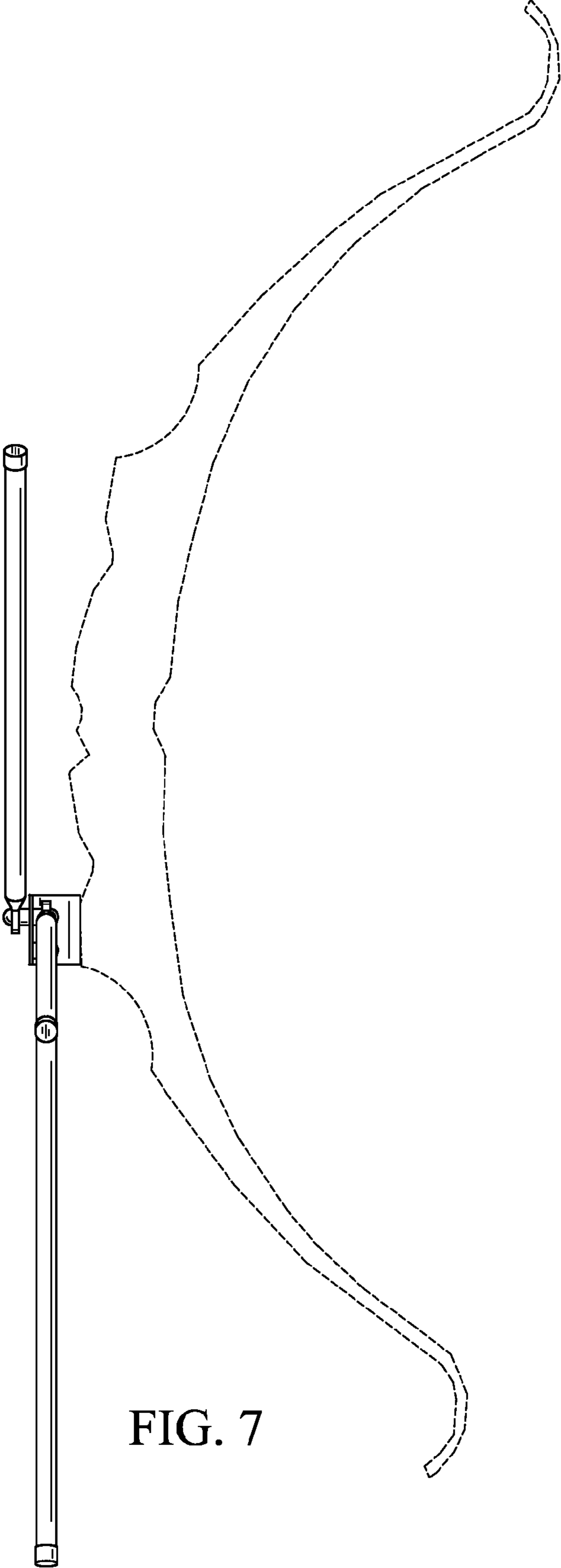

FIG. 7