



US00D588242S

(12) **United States Design Patent**
Hanna

(10) **Patent No.:** **US D588,242 S**
(45) **Date of Patent:** **** Mar. 10, 2009**

(54) **LAVATORY**

(57) **CLAIM**

(75) Inventor: **Ken S. Hanna**, Adell, WI (US)

The ornamental design for a lavatory, as shown and described.

(73) Assignee: **Kohler Co.**, Kohler, WI (US)

DESCRIPTION

(**) Term: **14 Years**

In a preferred embodiment, the nature of this product is as a plumbing fixture in the form of a lavatory which is primarily useful for washing various items and the body parts of humans.

(21) Appl. No.: **29/306,360**

(22) Filed: **Apr. 8, 2008**

FIG. 1 is a right, top, front perspective view of a lavatory embodying my new design;

(51) **LOC (9) Cl.** **23-02**

FIG. 2 is a top plan view thereof;

(52) **U.S. Cl.** **D23/284**

FIG. 3 is a front elevational view thereof, the rear elevational view thereof being a mirror image of the front shown;

(58) **Field of Classification Search** D23/271-274,
D23/284, 287, 291-293.1, 303, 308, 290;
4/630, 631, 637, 638, 661, 639-642, 619,
4/663-664

FIG. 4 is a right side elevational view thereof, the left side elevational view thereof being a mirror image of the right side shown;

See application file for complete search history.

FIG. 5 is a bottom plan view thereof;

(56) **References Cited**

FIG. 6 is a sectional view taken along line 6-6 in FIG. 2;

U.S. PATENT DOCUMENTS

FIG. 7 is a sectional view taken along line 7-7 in FIG. 2;

D538,903 S * 3/2007 Paterson D23/293.1

FIG. 8 is a right, top, front perspective view of a lavatory according to another embodiment of my new design having shading lines indicating transparency, the bottom plan view thereof being as shown in FIG. 5;

D560,781 S * 1/2008 Paterson D23/293.1

FIG. 9 is a top plan view thereof;

OTHER PUBLICATIONS

Kohler Co. "Iron Impressions 49" one-piece surface". Model No.: K-3053-4. Kohler Co. online catalog. Copyright 2008 Kohler Co.

FIG. 10 is a front elevational view thereof, the rear elevational view thereof being a mirror image of the front shown;

Duravit. "Starck 3 #030410". Duravit.us online catalog. Copyright 2008 Duravit.

FIG. 11 is a right side elevational view thereof, the left side elevational view thereof being a mirror image of the right side shown;

Atelier Design Group. "Cuadro Collection". Model No.: 522661. HomePortfolio.com online catalog. Copyright 1997-2007 HomePortfolio Inc.

FIG. 12 is a sectional view taken along line 12-12 in FIG. 9; and,

* cited by examiner

FIG. 13 is a sectional view taken along line 13-13 in FIG. 9.

The broken line representations in the figures are for the purpose of illustration only, and form no part of the claimed design.

Primary Examiner—Robert A Delehanty

1 Claim, 5 Drawing Sheets

(74) *Attorney, Agent, or Firm*—Quarles & Brady LLP

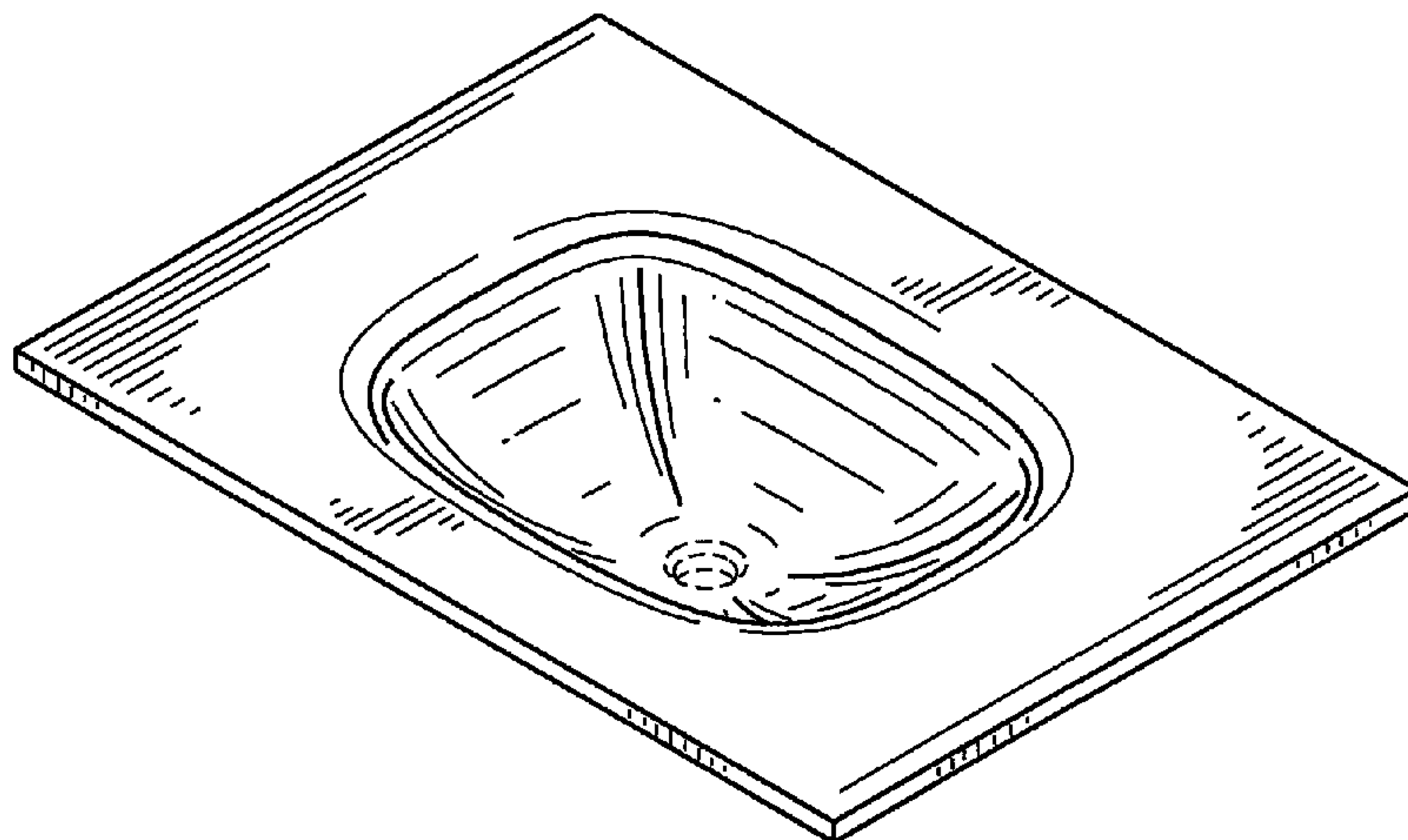

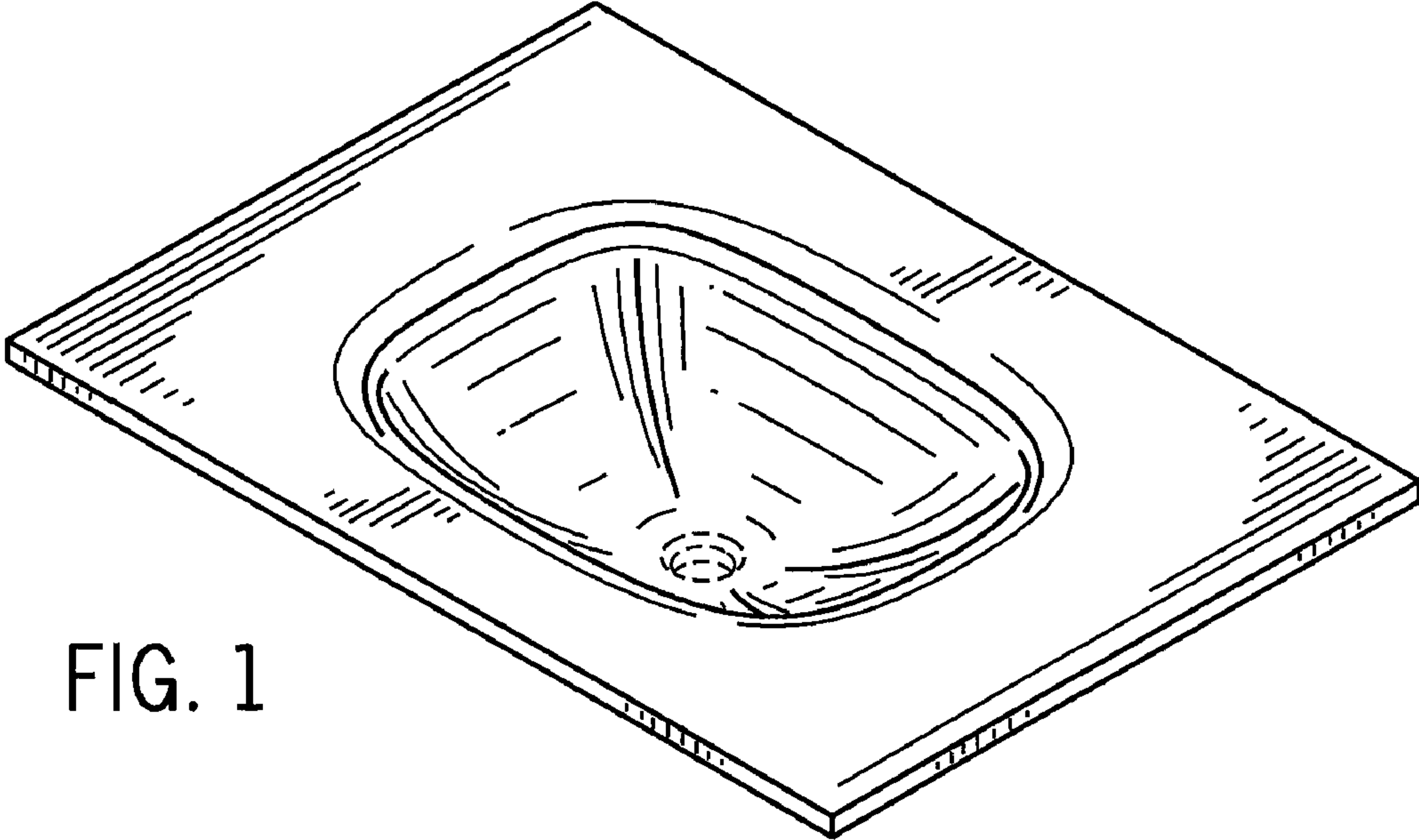

FIG. 1

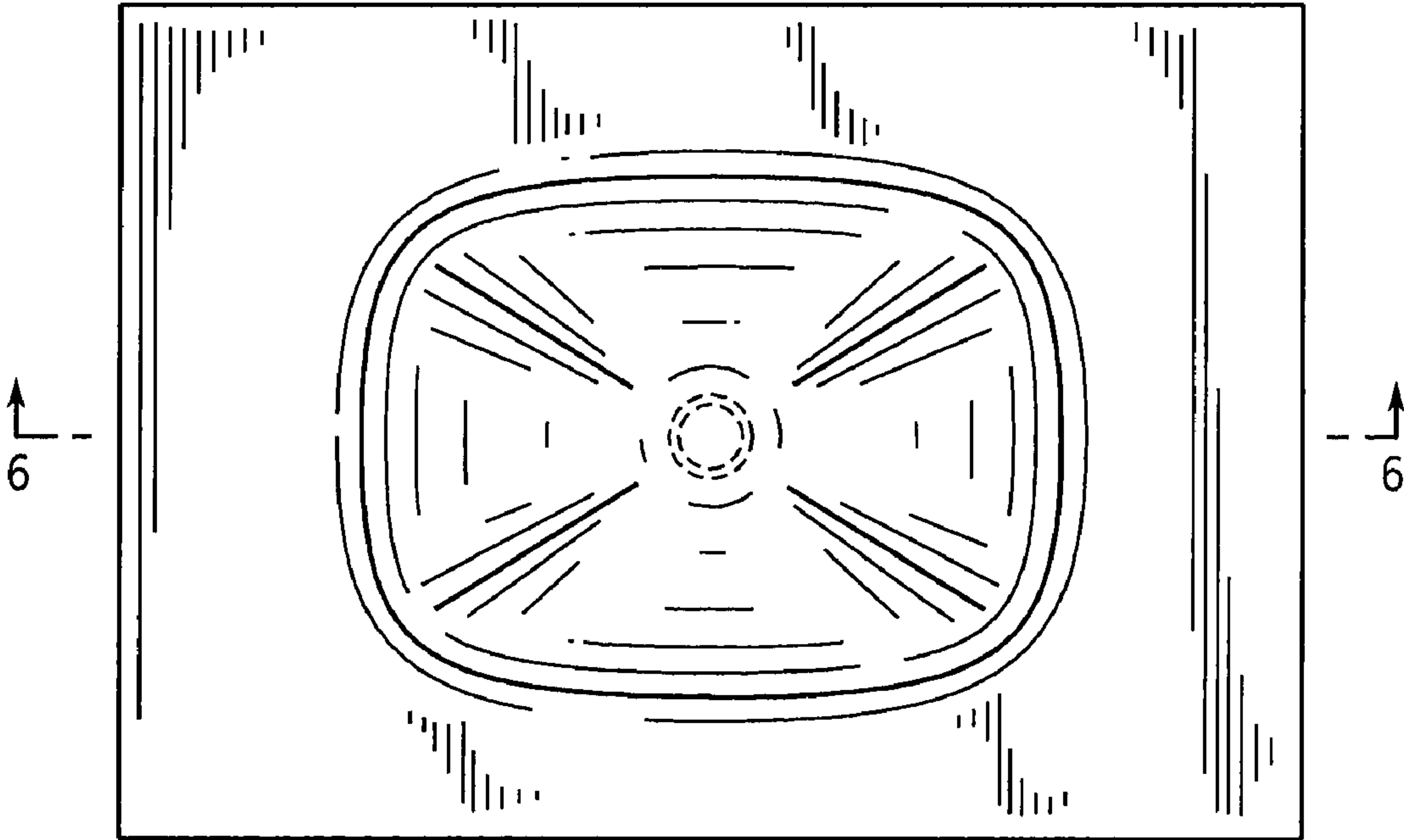
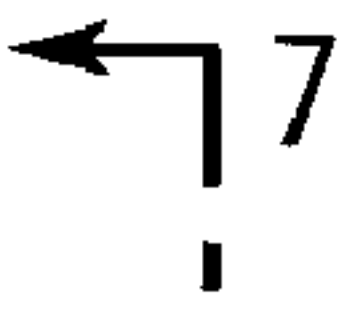

FIG. 2

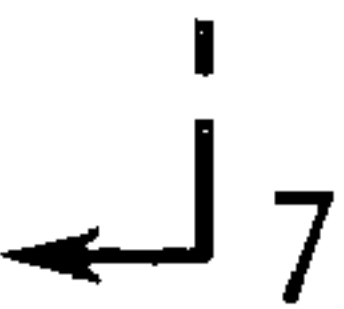

FIG. 3

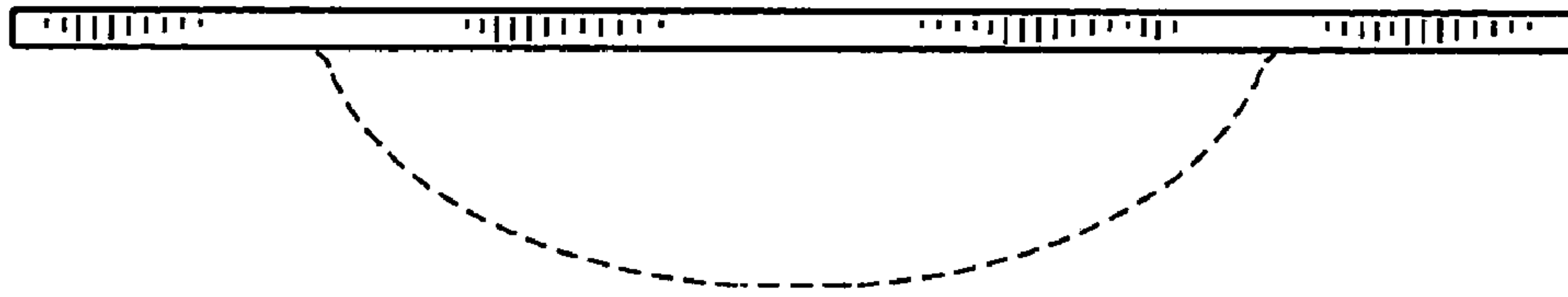

FIG. 4

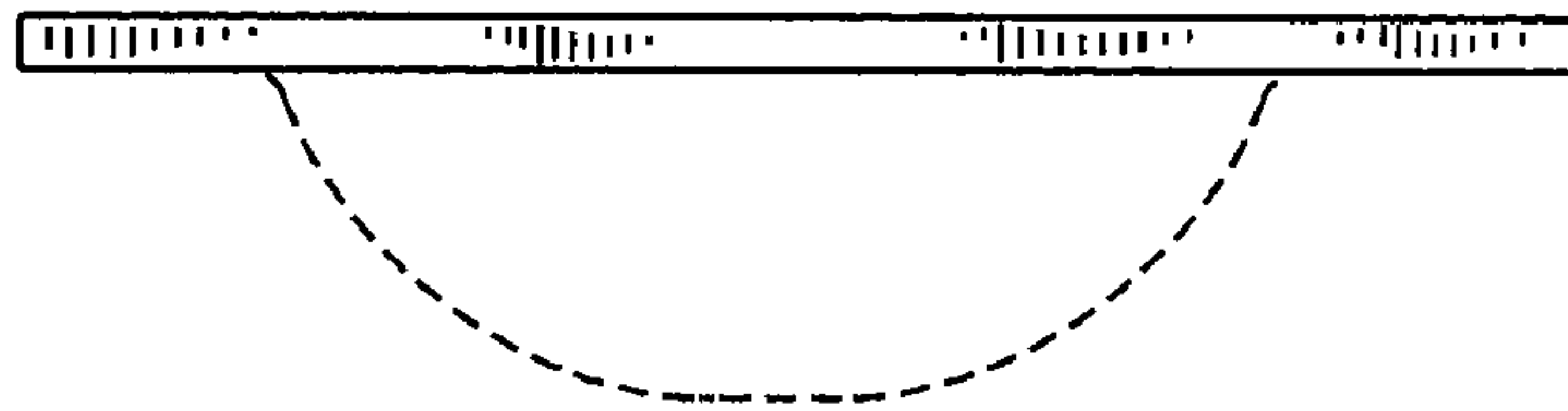

FIG. 5

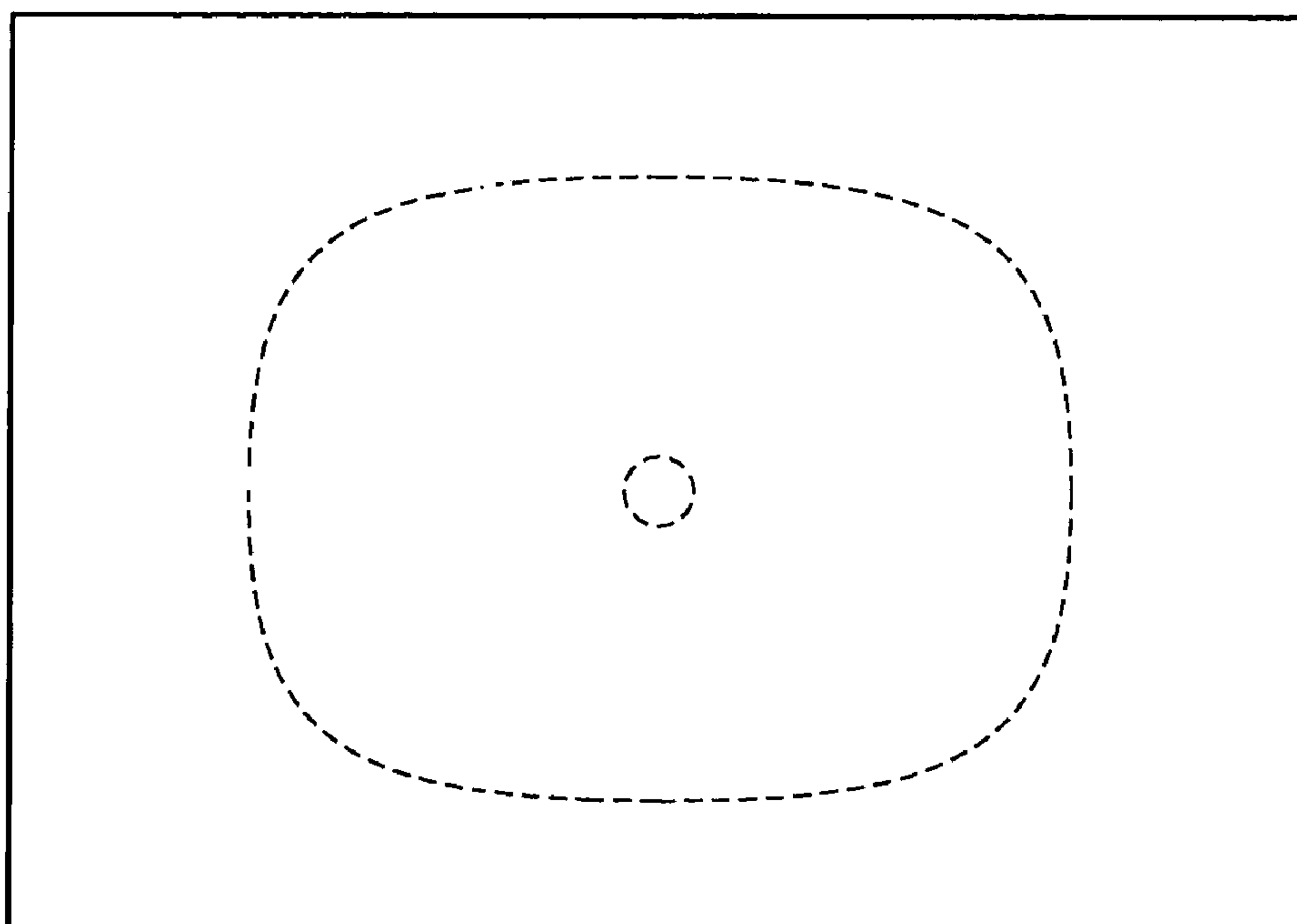

FIG. 6

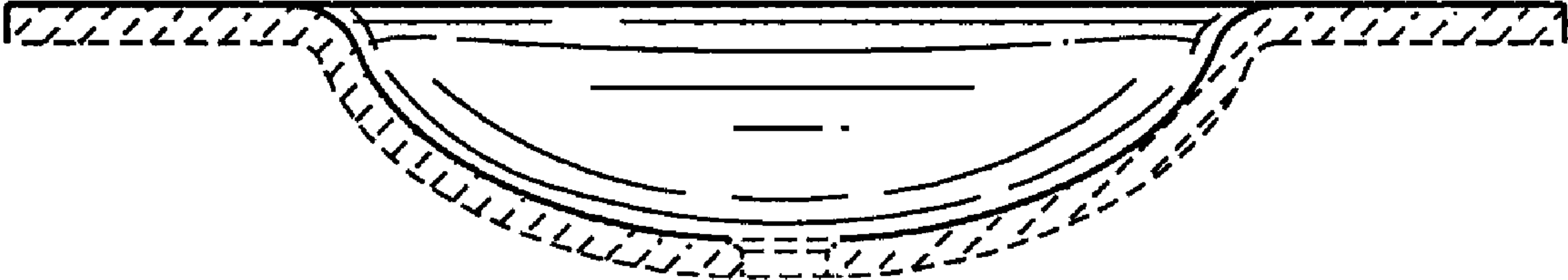

FIG. 7



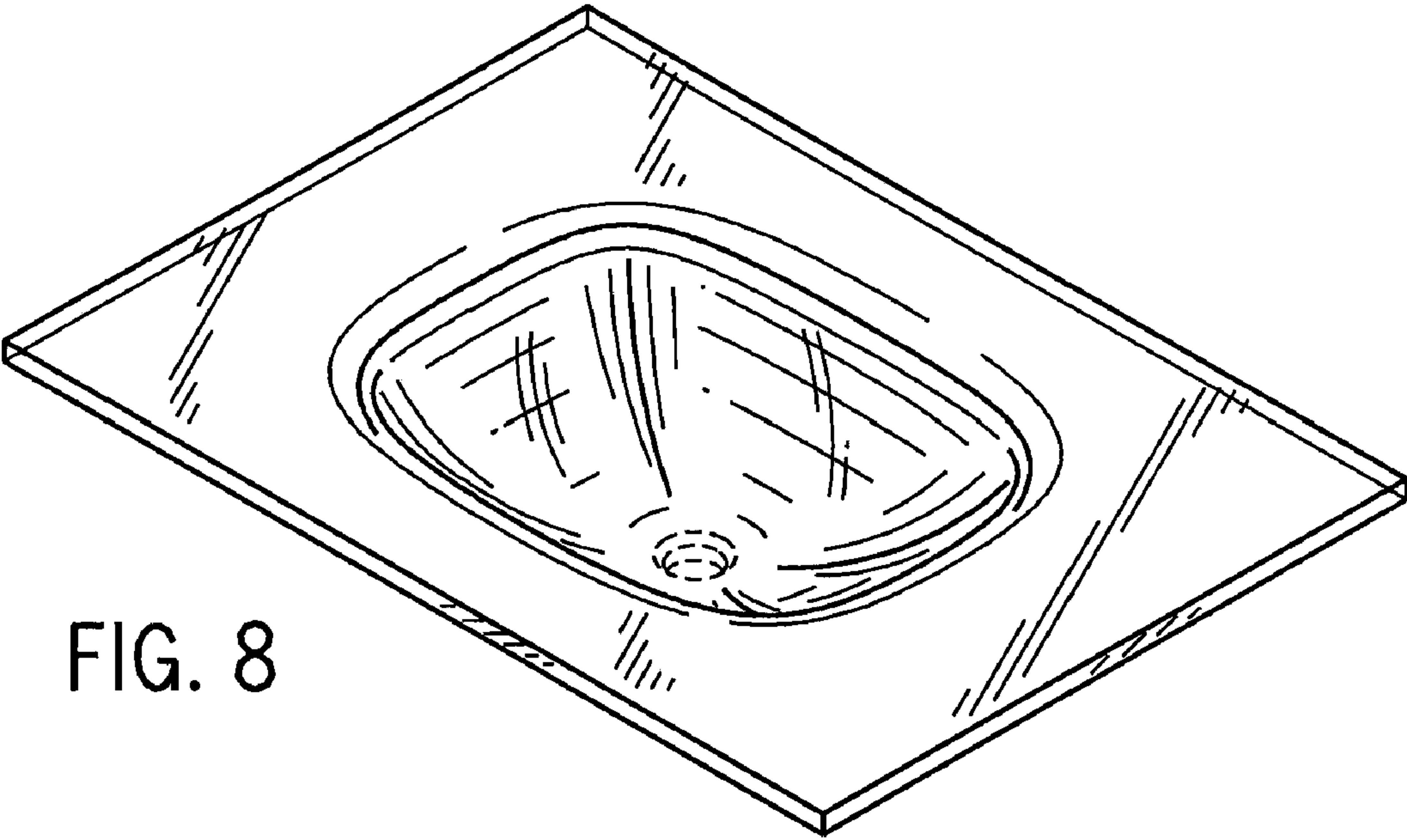

FIG. 8

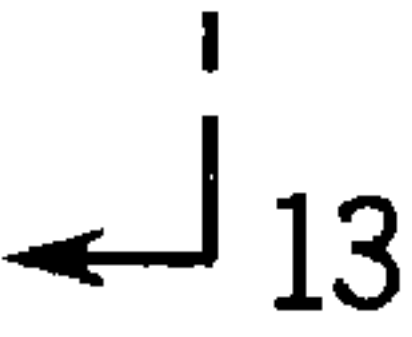
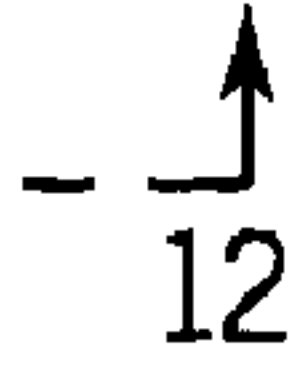
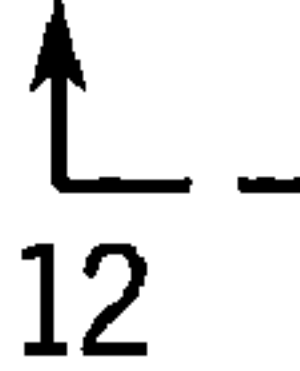
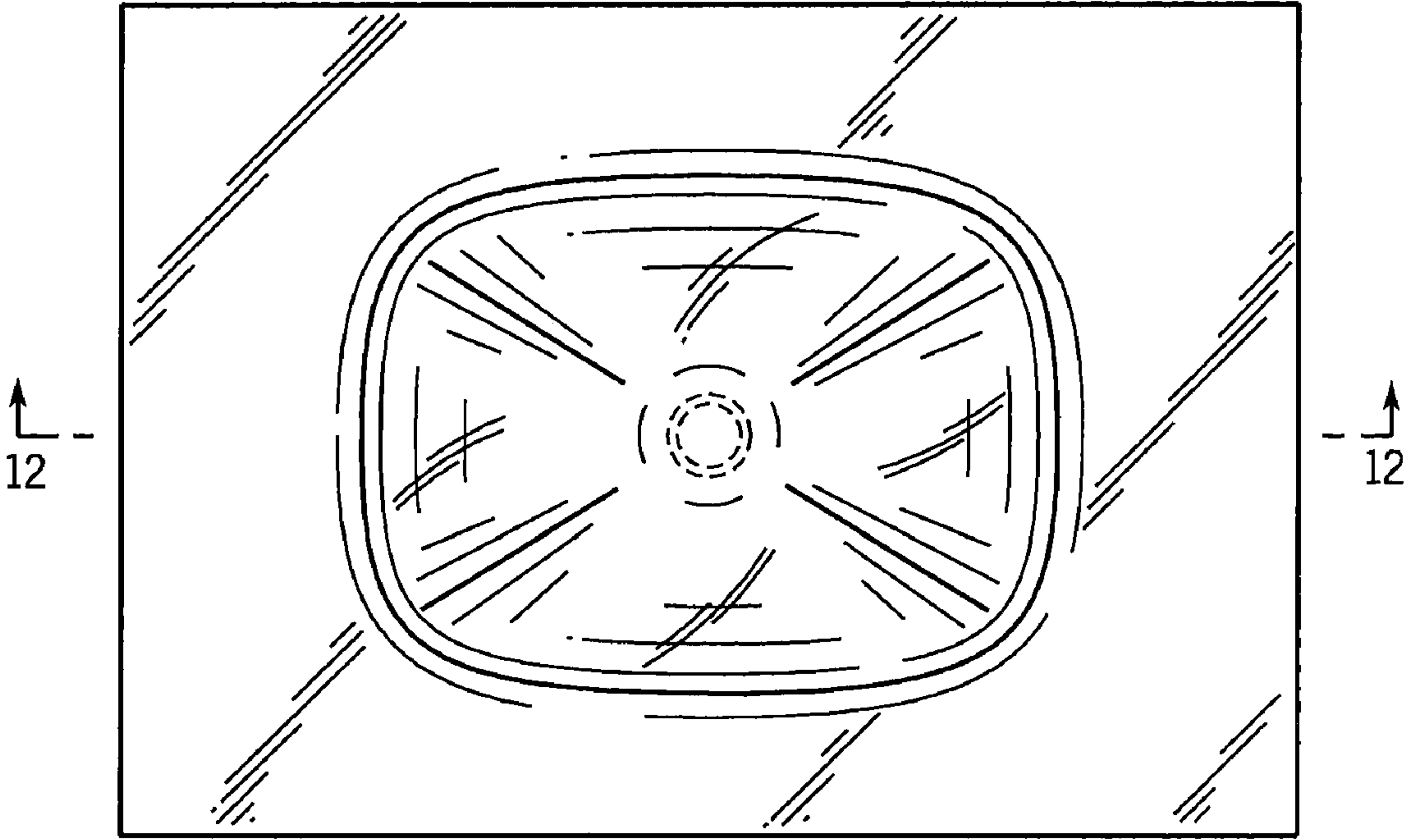
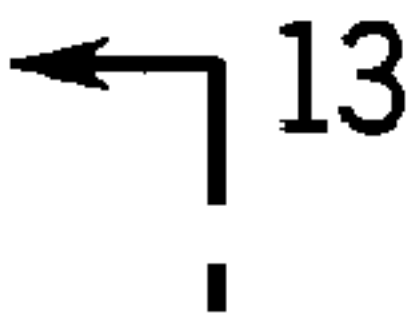

FIG. 9

FIG. 10

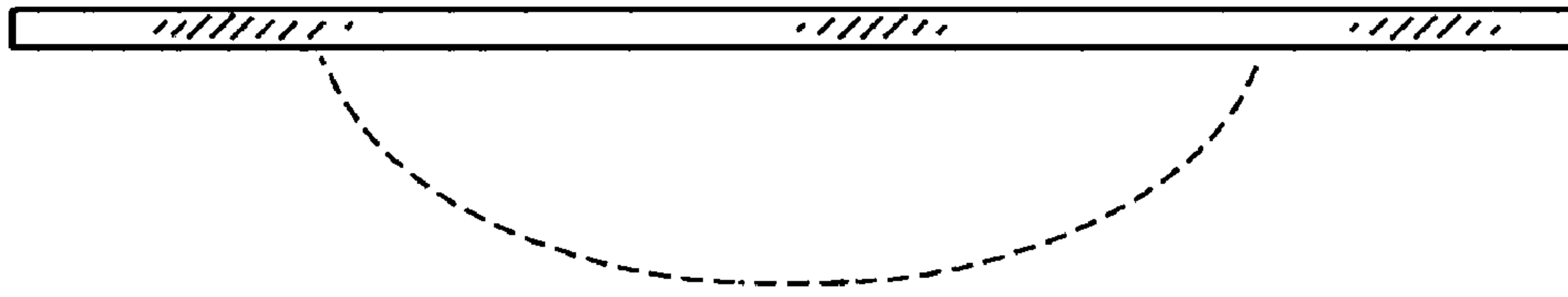

FIG. 11

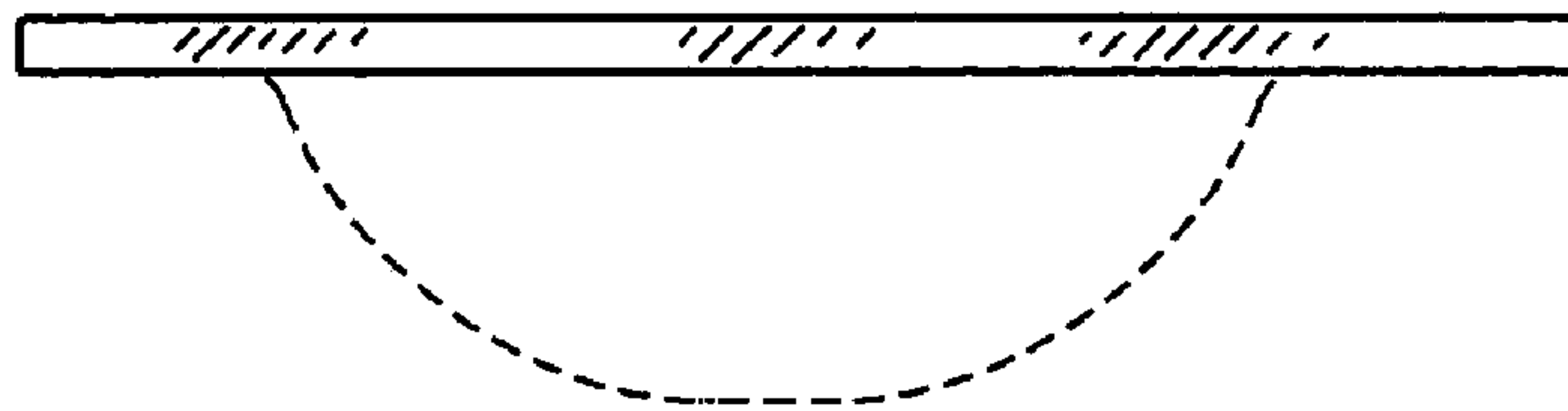

FIG. 12

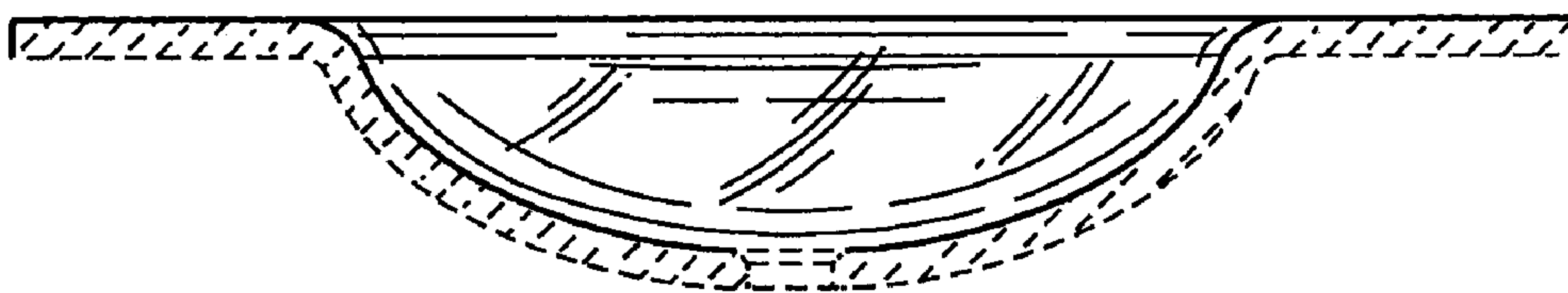

FIG. 13

