



US00D588105S

(12) **United States Design Patent**
Altman

(10) **Patent No.:** **US D588,105 S**
(45) **Date of Patent:** **** Mar. 10, 2009**

(54) **AUDIO SPEAKER**

(75) Inventor: **Larry Altman**, Camrillo, CA (US)

(73) Assignee: **KRK Systems, LLC**, Hollywood, FL (US)

(**) Term: **14 Years**

(21) Appl. No.: **29/294,367**

(22) Filed: **Jan. 8, 2008**

(51) **LOC (9) Cl.** **14-01**

(52) **U.S. Cl.** **D14/215**

(58) **Field of Classification Search** D14/204,
D14/210–216, 172; 181/143–144, 147–148,
181/150–153, 157, 198–199; 381/300–303,
381/306, 332–333, 336, 345, 361–364, 386–388
See application file for complete search history.

(56) **References Cited**

U.S. PATENT DOCUMENTS

4,221,929	A *	9/1980	Fukuda	381/386
D268,673	S *	4/1983	Iijima	D14/214
D434,751	S *	12/2000	Sogabe et al.	D14/215
D439,239	S *	3/2001	Ito et al.	D14/215
D480,068	S *	9/2003	Shin	D14/215

D484,115	S *	12/2003	Nishii et al.	D14/215
D541,790	S *	5/2007	Yoon	D14/215
D544,466	S *	6/2007	Pincek et al.	D14/214

* cited by examiner

Primary Examiner—Nanda Bondade

(74) *Attorney, Agent, or Firm*—Day Pitney LLP

(57) **CLAIM**

The ornamental design for an audio speaker, as shown and described.

DESCRIPTION

FIG. 1 is a top front and right side perspective view of an audio speaker showing my new design;
FIG. 2 is front elevational view thereof;
FIG. 3 is a rear elevational view thereof;
FIG. 4 is a right side elevational view thereof;
FIG. 5 is a top plan view thereof; and,
FIG. 6 is a bottom plan view thereof.

The broken line showing on the drawing disclosure is for illustrative purposes only and forms no part of the claimed design.

1 Claim, 6 Drawing Sheets

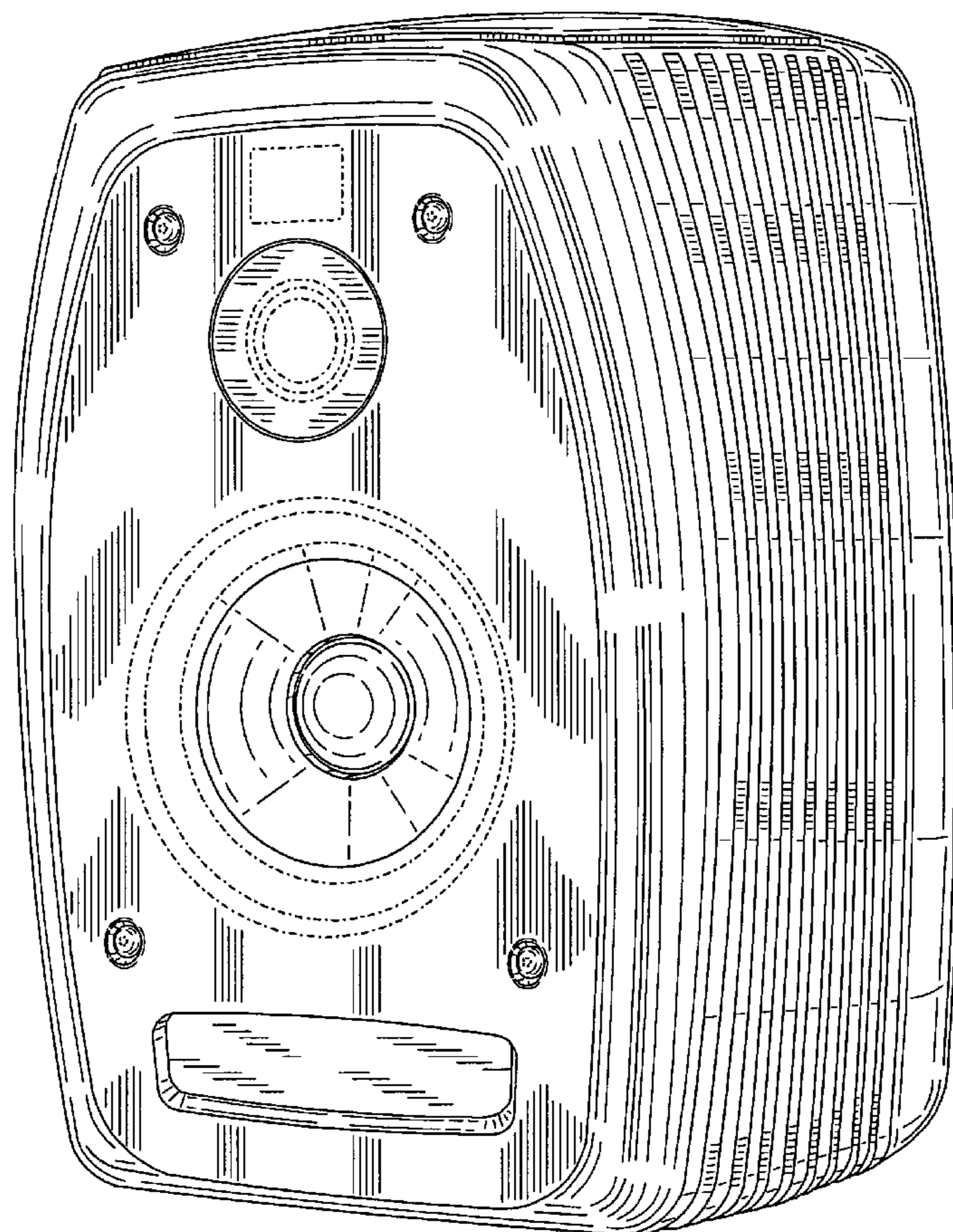

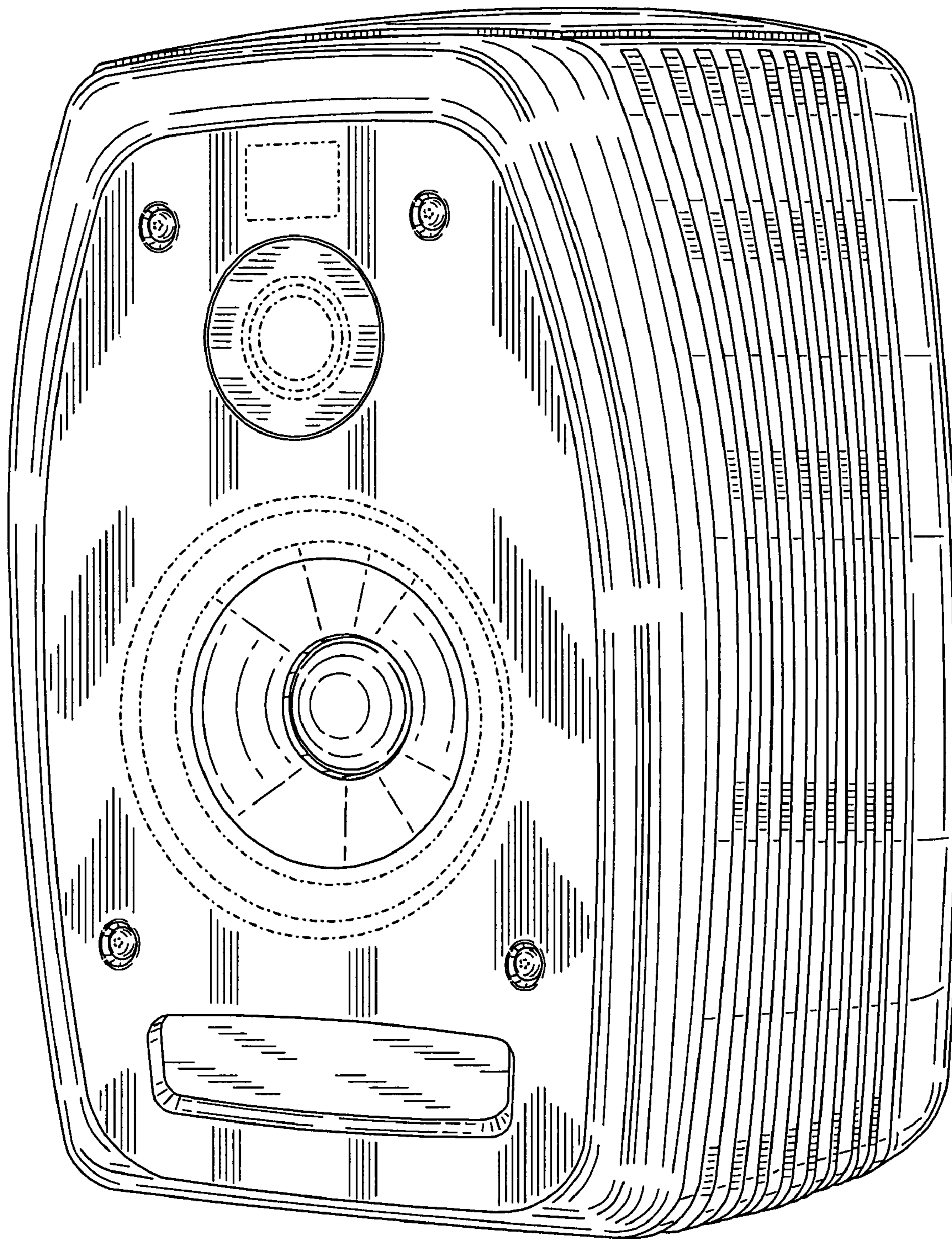

FIG. 1

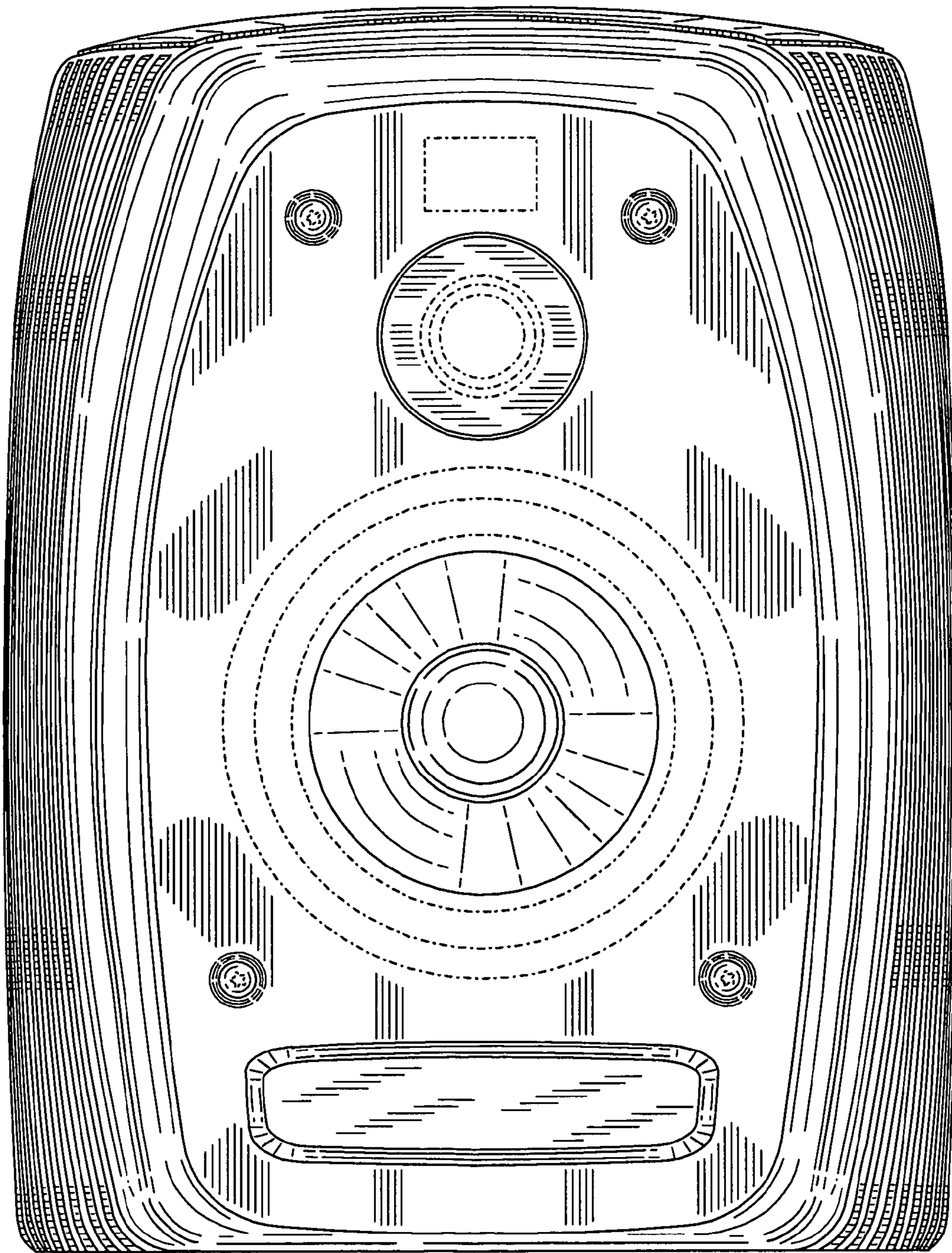

FIG. 2

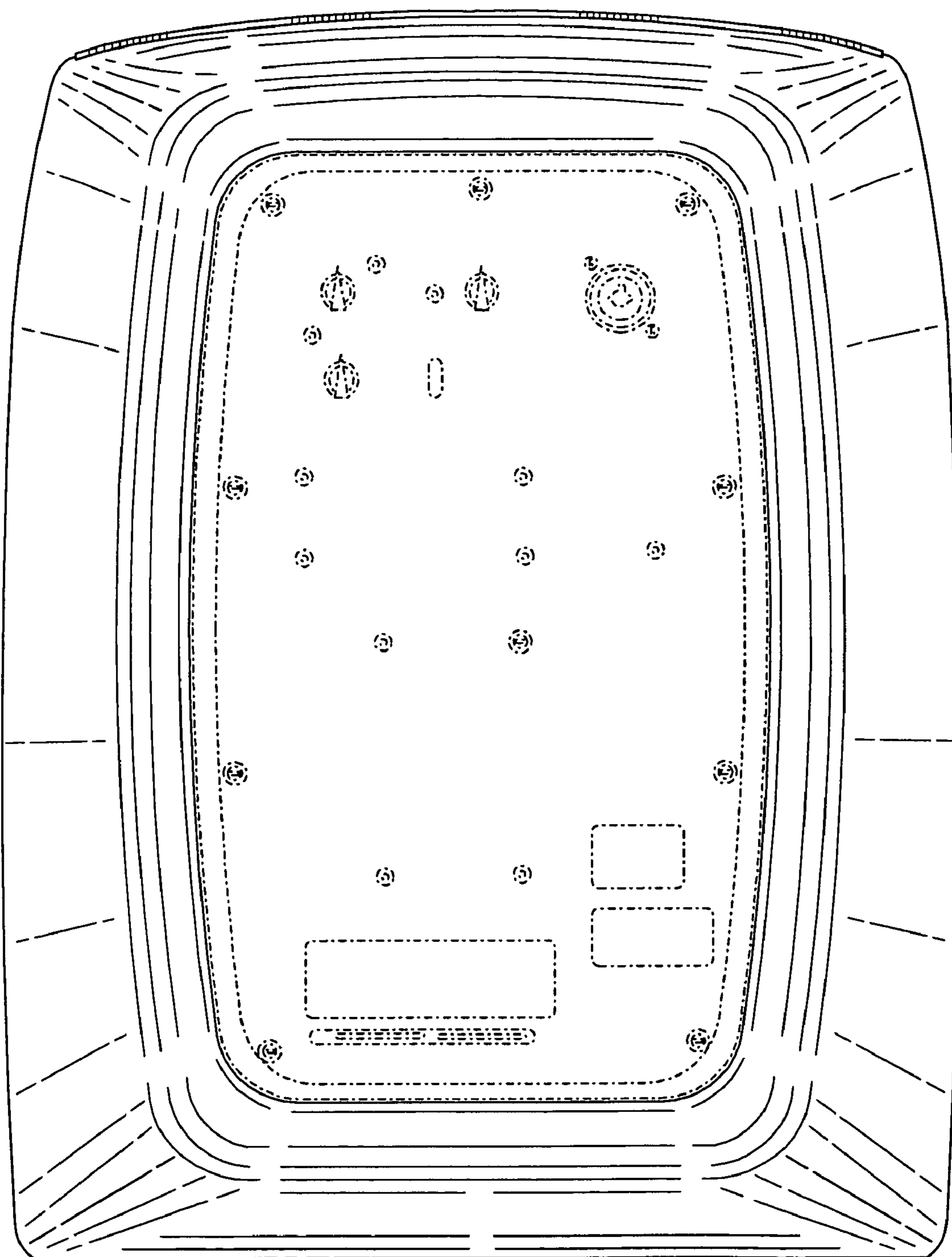

FIG. 3

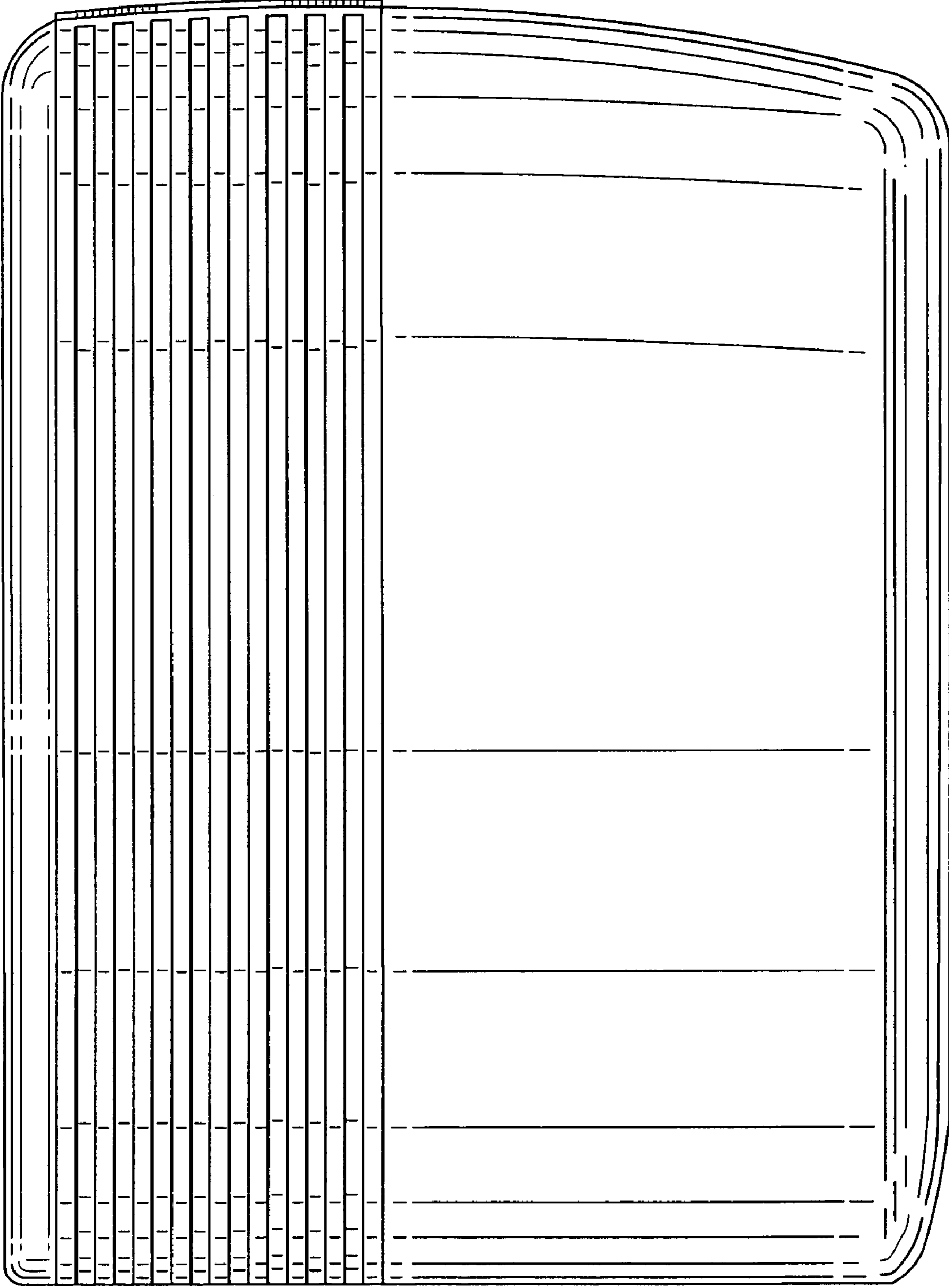

FIG. 4

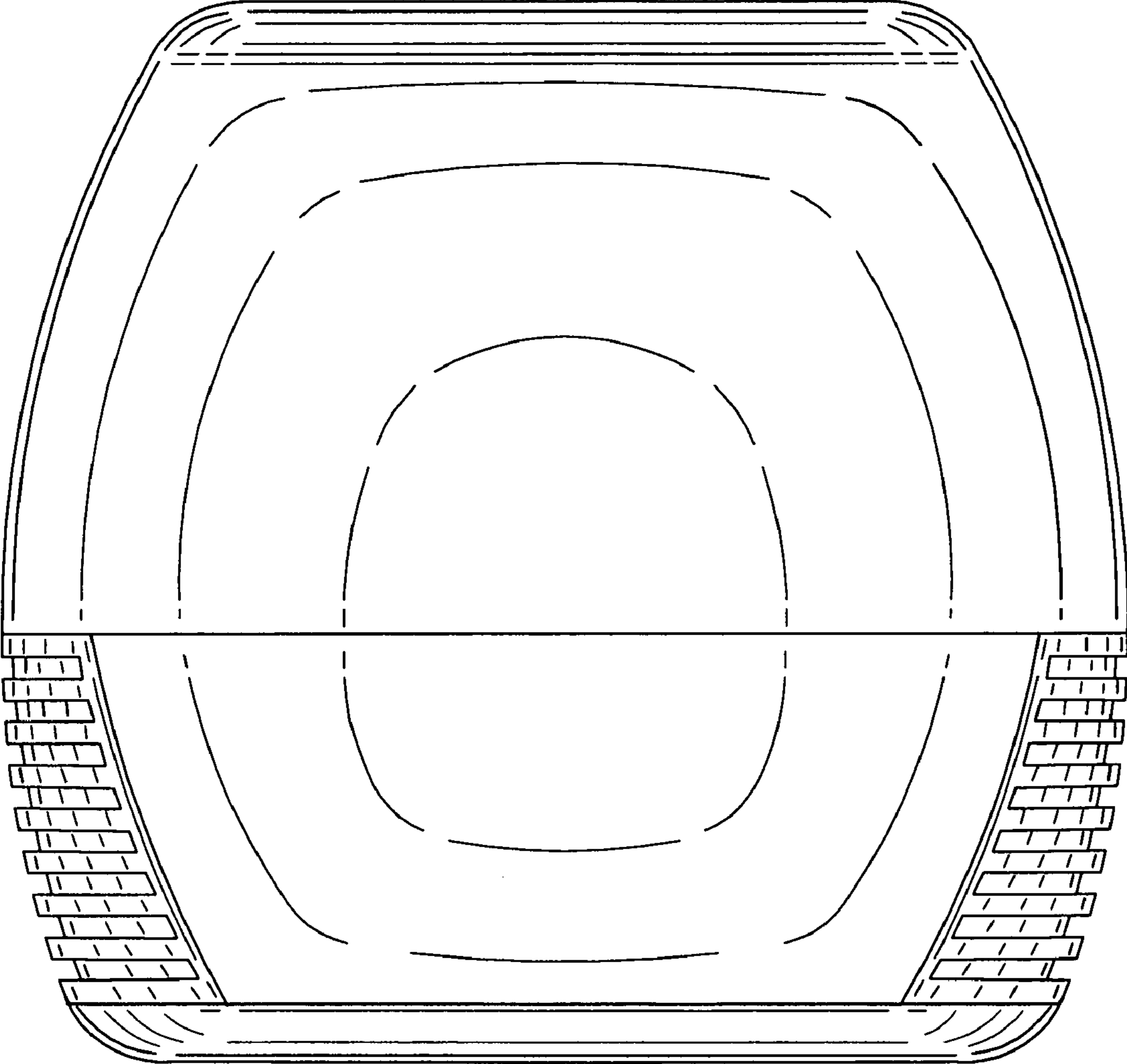

FIG. 5

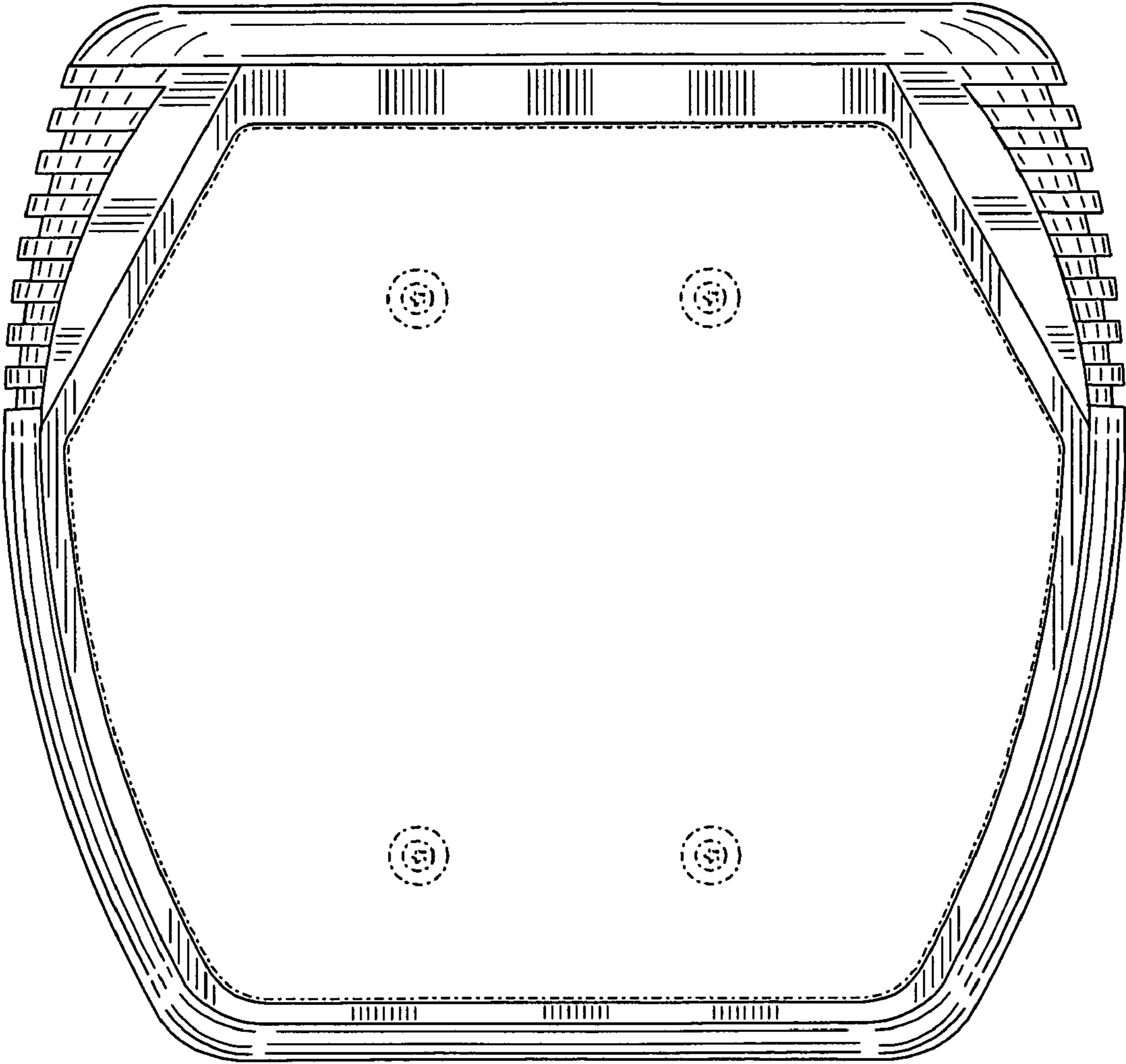

FIG. 6