



US00D588091S

(12) **United States Design Patent**
Nguyen et al.

(10) **Patent No.:** **US D588,091 S**
(45) **Date of Patent:** **** Mar. 10, 2009**

(54) **HANDSET**

(75) Inventors: **Linh D. Nguyen**, San Diego, CA (US);
Edward Mitchell, Thousand Oaks, CA
(US); **Leonard Wozniak**, Santa Monica,
CA (US)

(73) Assignee: **Nokia Corporation**, Espoo (FI)

(**) Term: **14 Years**

(21) Appl. No.: **29/321,571**

(22) Filed: **Jul. 18, 2008**

(51) **LOC (9) Cl.** **14-03**

(52) **U.S. Cl.** **D14/138 AB**

(58) **Field of Classification Search** D14/138 AB,
D14/138 AA, 496, 341-347, 247, 455-456,
D14/218; 455/575.3, 575.1

See application file for complete search history.

(56) **References Cited**

U.S. PATENT DOCUMENTS

D500,750 S *	1/2005	Arnholt et al.	D14/138 AB
D503,697 S	4/2005	Kim	
D504,879 S	5/2005	Moss	
D507,551 S *	7/2005	Kim et al.	D14/138 AB
D522,989 S	6/2006	Viitasaari	
D537,059 S *	2/2007	Hwang	D14/138 AB
D542,771 S *	5/2007	Cho et al.	D14/138 AB
D551,645 S *	9/2007	Kim et al.	D14/138 AB
D552,574 S	10/2007	Moss	
D554,093 S *	10/2007	Arnholt et al.	D14/138 AB

(Continued)

OTHER PUBLICATIONS

Nokia 6650 T-Mobile telephone, announced Mar. 2008, [online], [site visited Nov. 4, 2008]. Available from Internet ,<URL: http://www.gsmarena.com>.*

Nokia N76 telephone, announced Jan. 2007, [online], [site visited Nov. 4, 2008]. Available from Internet ,<URL: http://www.gsmarena.com>.*

Samsung G400 Soul telephone, announced Mar. 2008, [online], [site visited Nov. 4, 2008]. Available from Internet ,<URL: http://www.gsmarena.com>.*

Motorola RAZR2 V8 telephone, announced May 2007, [online], [site visited Nov. 4, 2008]. Available from Internet ,<URL: http://www.gsmarena.com>.*

LG Trax CU575 telephone, announced Aug. 2007, [online], [site visited Nov. 4, 2008]. Available from Internet ,<URL: http://www.gsmarena.com>.*

LG P7200 telephone, announced Aug. 2005, [online], [site visited Nov. 4, 2008]. Available from Internet ,<URL: http://www.gsmarena.com>.*

BenQ-Siemens EF81 telephone, announced Jan. 2006, [online], [site visited Nov. 4, 2008]. Available from Internet ,<URL: http://www.gsmarena.com>.*

Primary Examiner—Jeffrey D Asch

(74) *Attorney, Agent, or Firm*—Banner & Witcoff, Ltd.

(57) **CLAIM**

The ornamental design for a handset, as shown and described.

DESCRIPTION

FIG. 1 is a perspective front view of a handset showing we new design;

FIG. 2 is a front view thereof;

FIG. 3 is a rear view thereof;

FIG. 4 is a right side view thereof;

FIG. 5 is a left side view thereof;

FIG. 6 is a top view thereof;

FIG. 7 is a bottom view thereof; and,

FIG. 8 is a perspective rear view thereof.

The broken lines throughout the views that are immediately adjacent to the shaded areas, and define unshaded regions, represent the bounds of the claimed design, while all other broken lines are directed to environment and are for illustrative purposes only; the broken lines form no part of the claimed design.

1 Claim, 6 Drawing Sheets

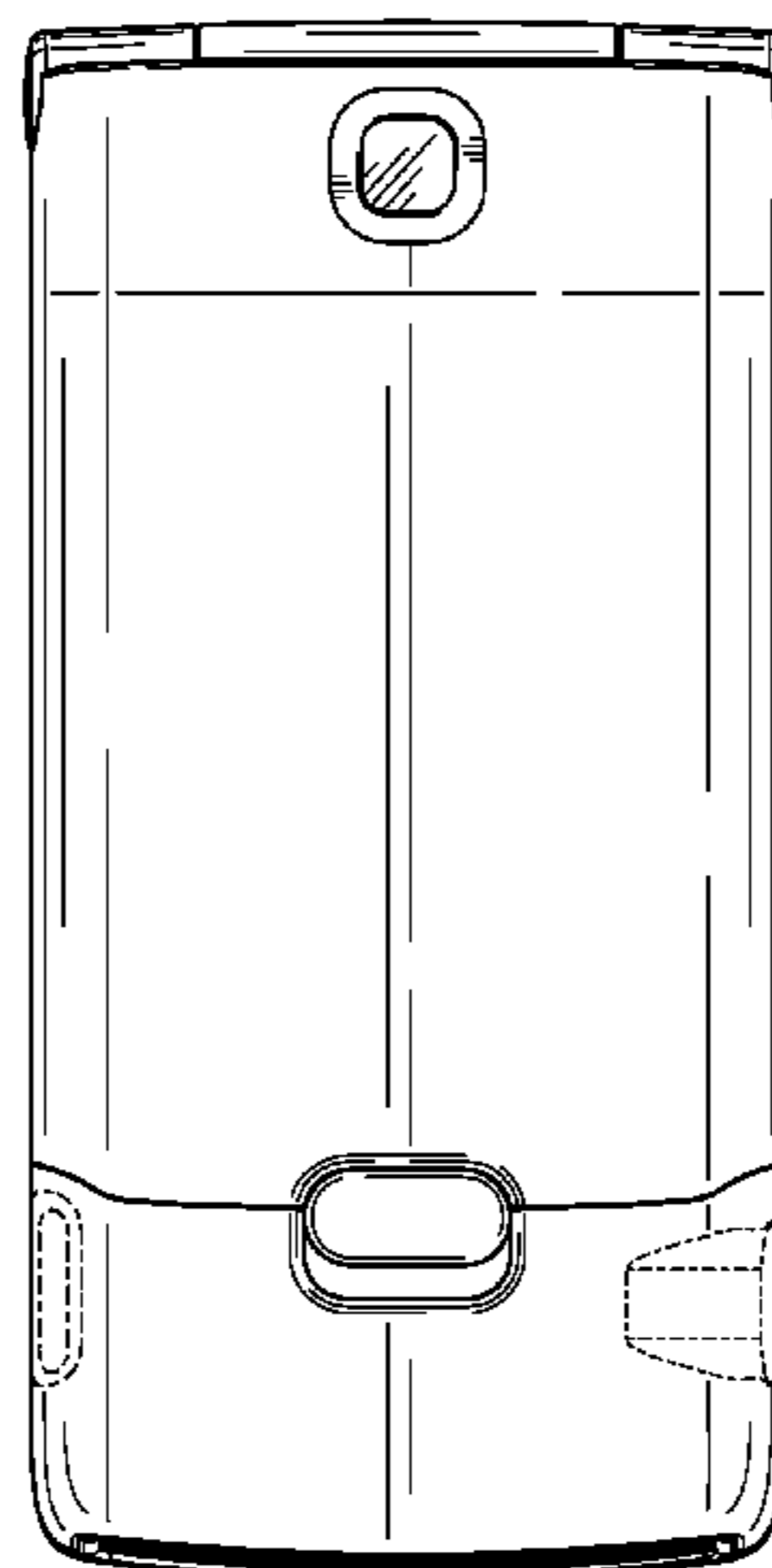
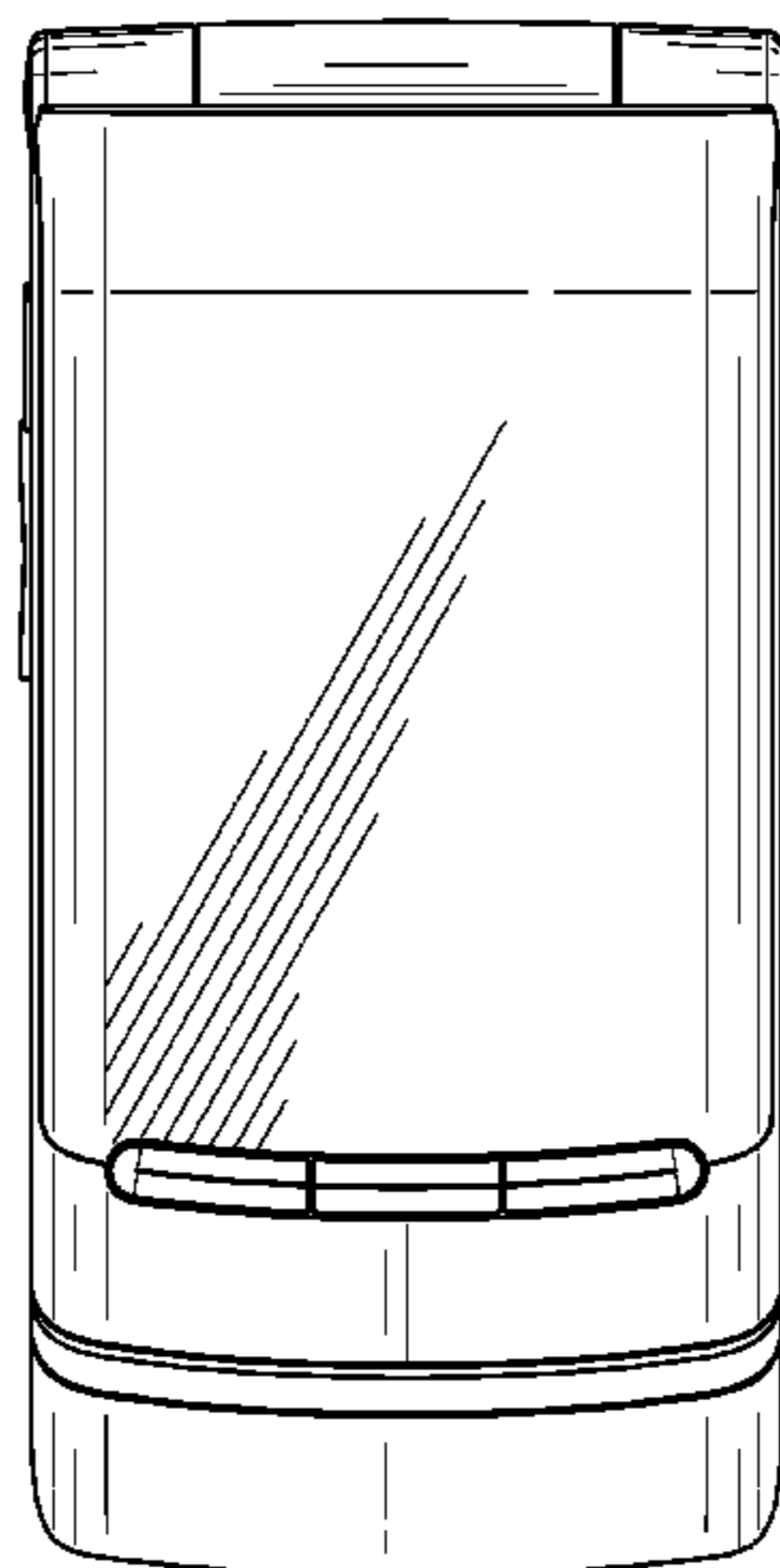

US D588,091 S

Page 2

U.S. PATENT DOCUMENTS

D554,094 S *	10/2007	Ribeiro et al.	D14/138 AB	D573,574 S *	7/2008	Suk et al.	D14/138
D555,614 S	11/2007	Holmung et al.		D575,754 S *	8/2008	Lee	D14/138
D563,358 S *	3/2008	Baik et al.	D14/138 AB	D575,758 S *	8/2008	Nilsen et al.	D14/138
D563,933 S *	3/2008	Lee et al.	D14/138 AB	D578,092 S *	10/2008	Lee	D14/138 AB
D564,480 S	3/2008	Linares et al.		D578,097 S *	10/2008	Lee et al.	D14/138 AB
D566,670 S *	4/2008	Huang	D14/138 AB	D578,501 S *	10/2008	Seo et al.	D14/138 AB
D567,209 S *	4/2008	Moss et al.	D14/138 AB	D578,504 S *	10/2008	Stillerman	D14/138 AB
D568,850 S	5/2008	Lyles		D578,981 S *	10/2008	Park et al.	D14/138 R
D571,344 S *	6/2008	Kim et al.	D14/138	D578,988 S *	10/2008	Chung et al.	D14/138 R
D572,690 S *	7/2008	Kim et al.	D14/138	D579,894 S *	11/2008	Yabe et al.	D14/138 R
D573,569 S *	7/2008	Arnholt et al.	D14/138	D580,386 S *	11/2008	Cho et al.	D14/138 R

* cited by examiner

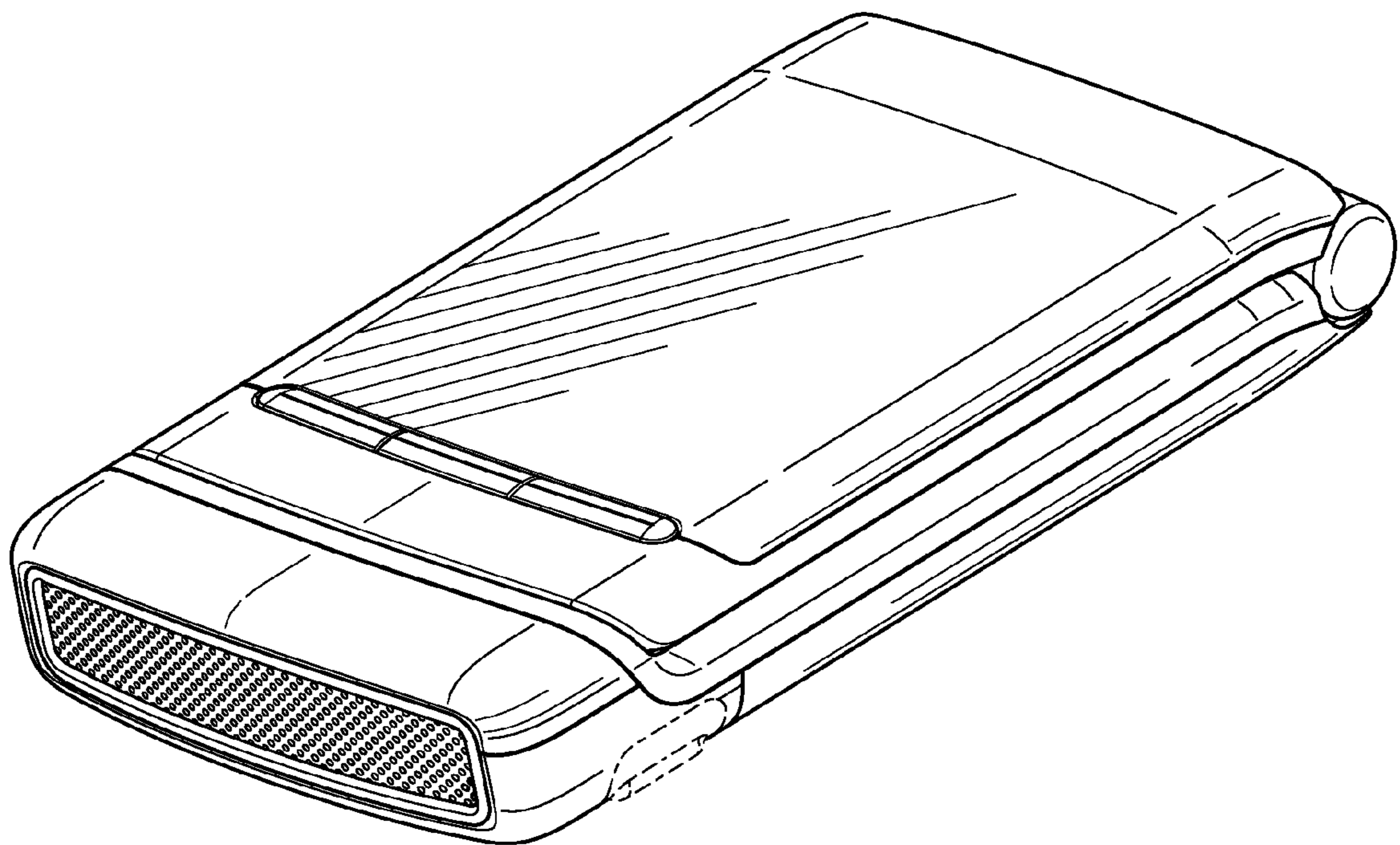

FIG. 1

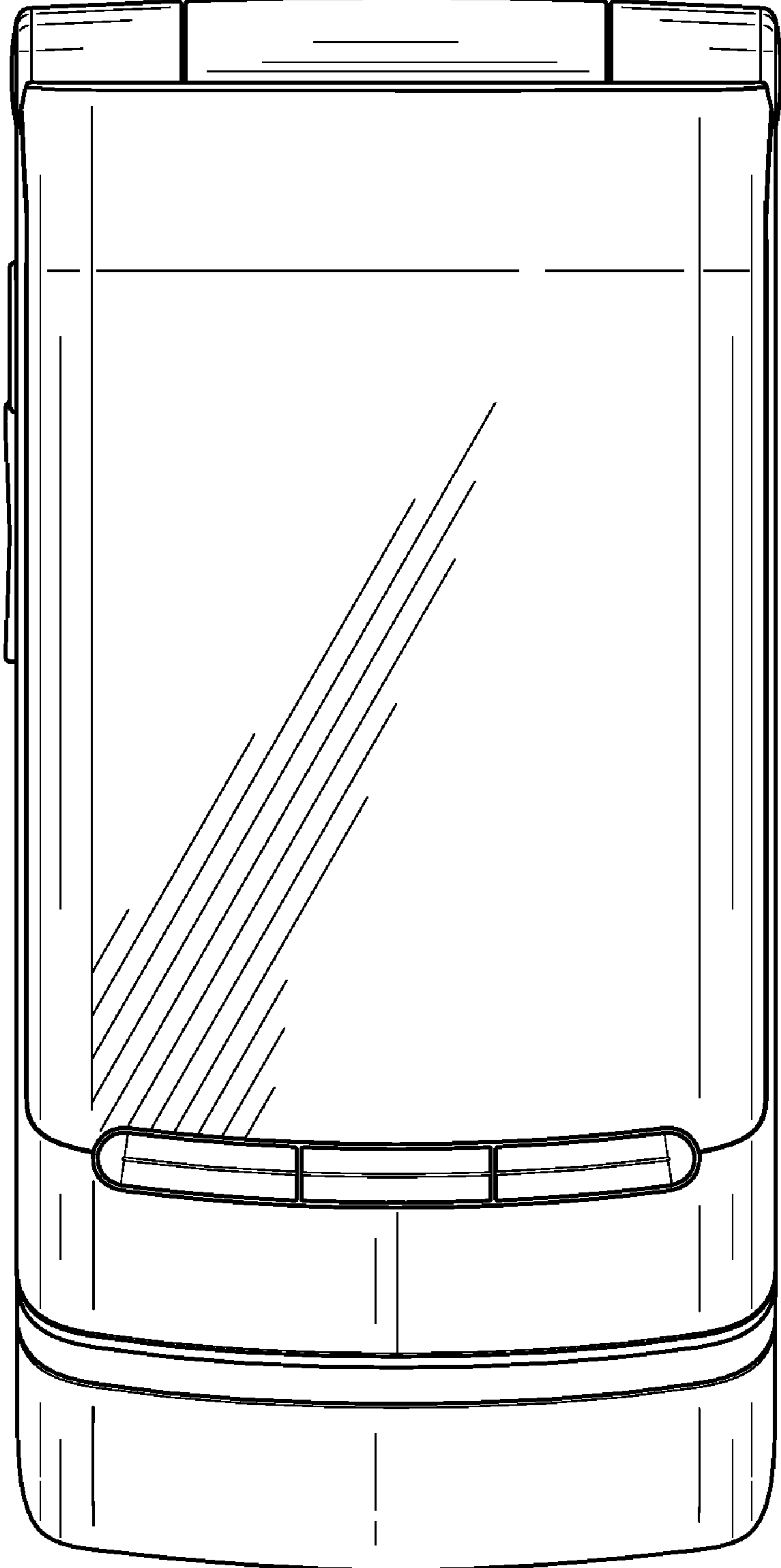

FIG. 2

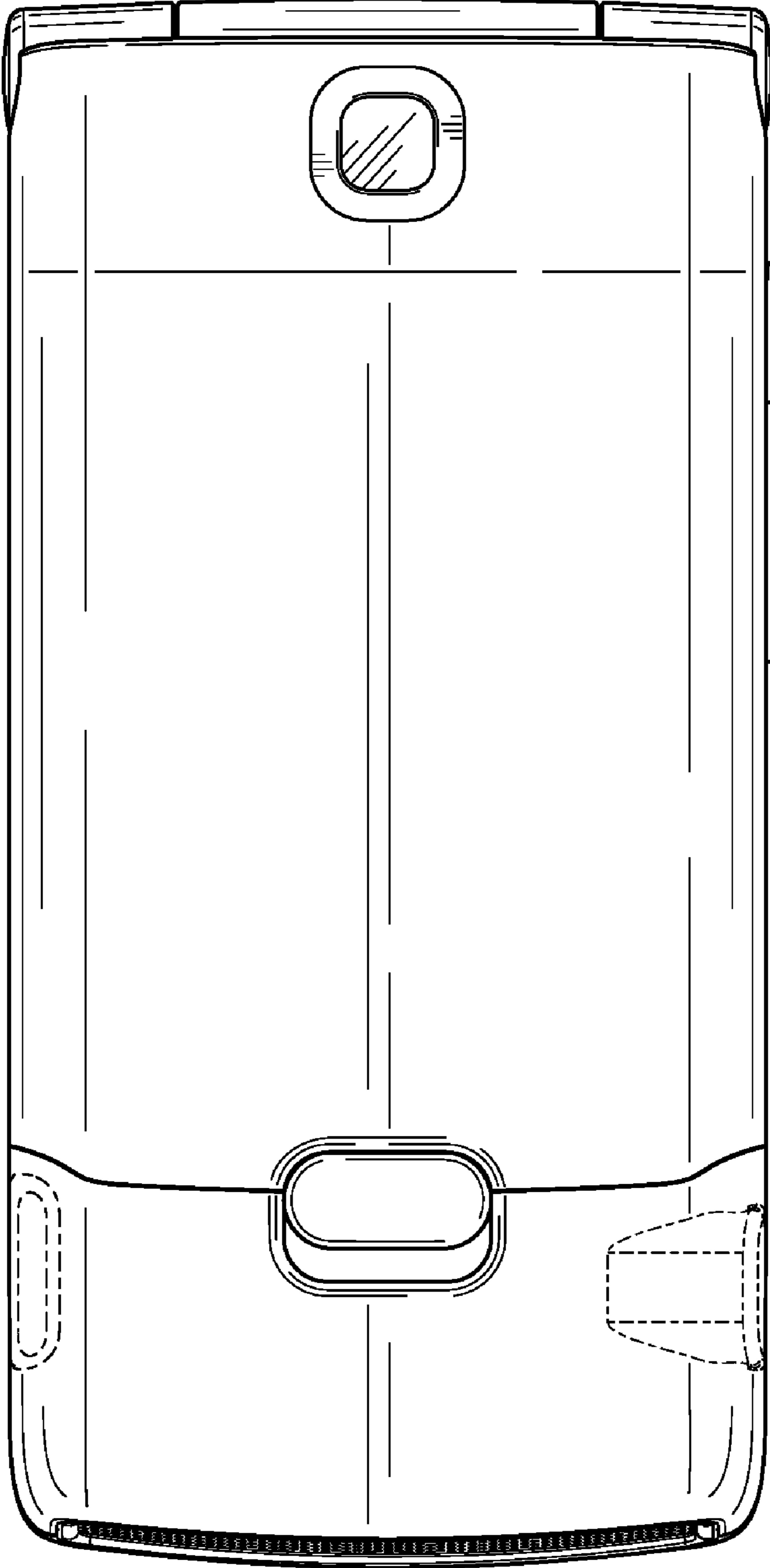

FIG. 3

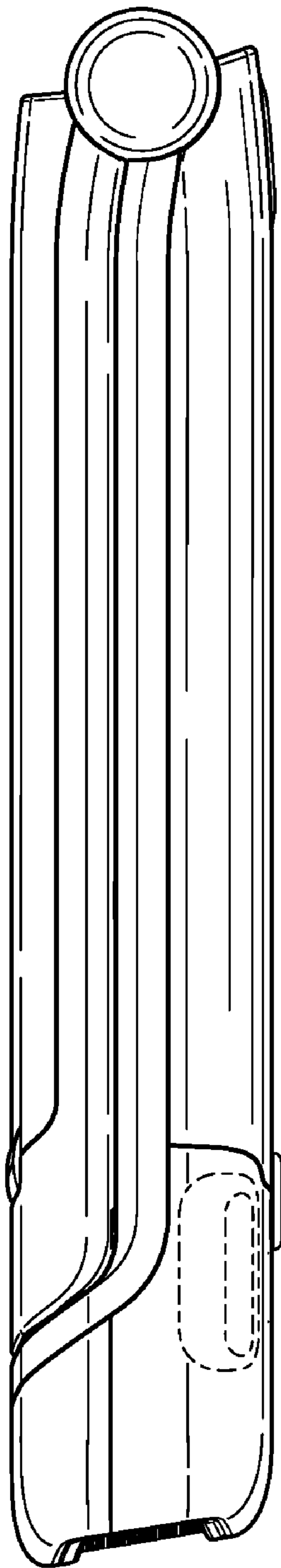

FIG. 4

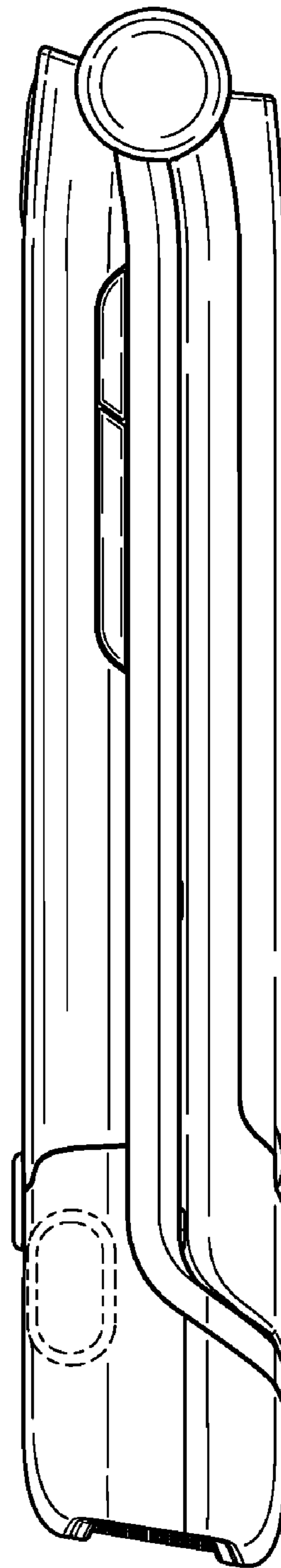

FIG. 5

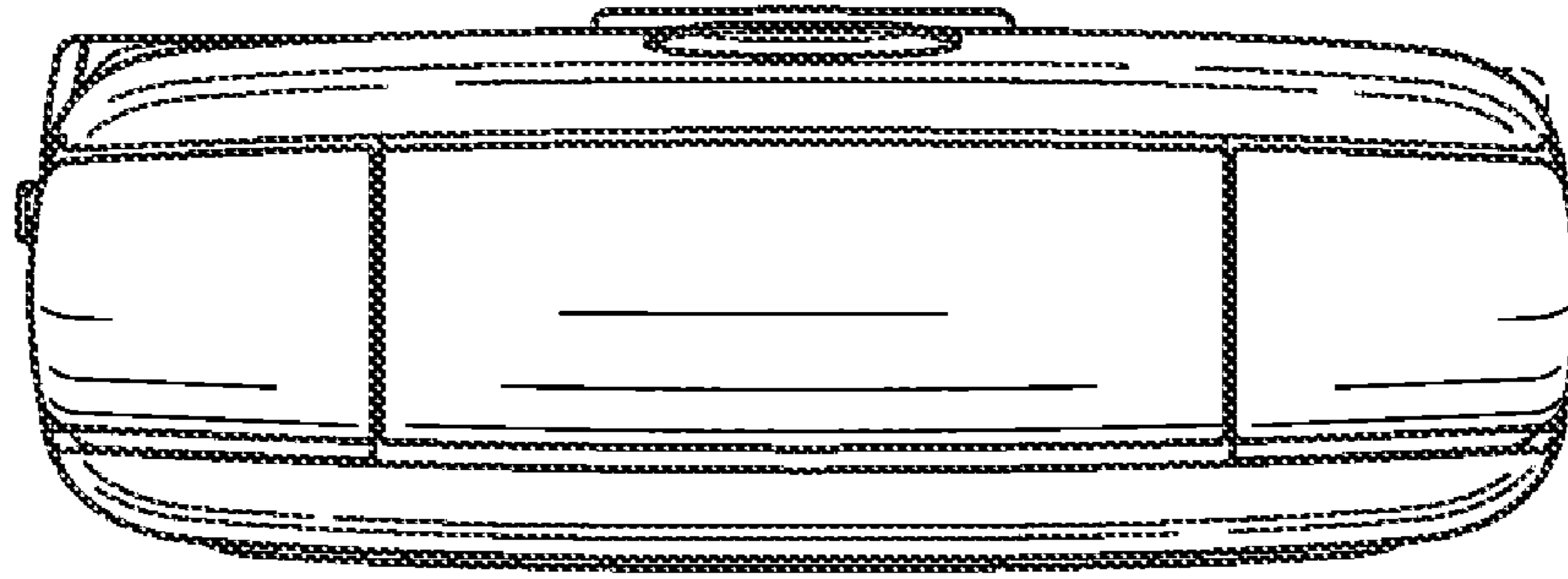

FIG. 6

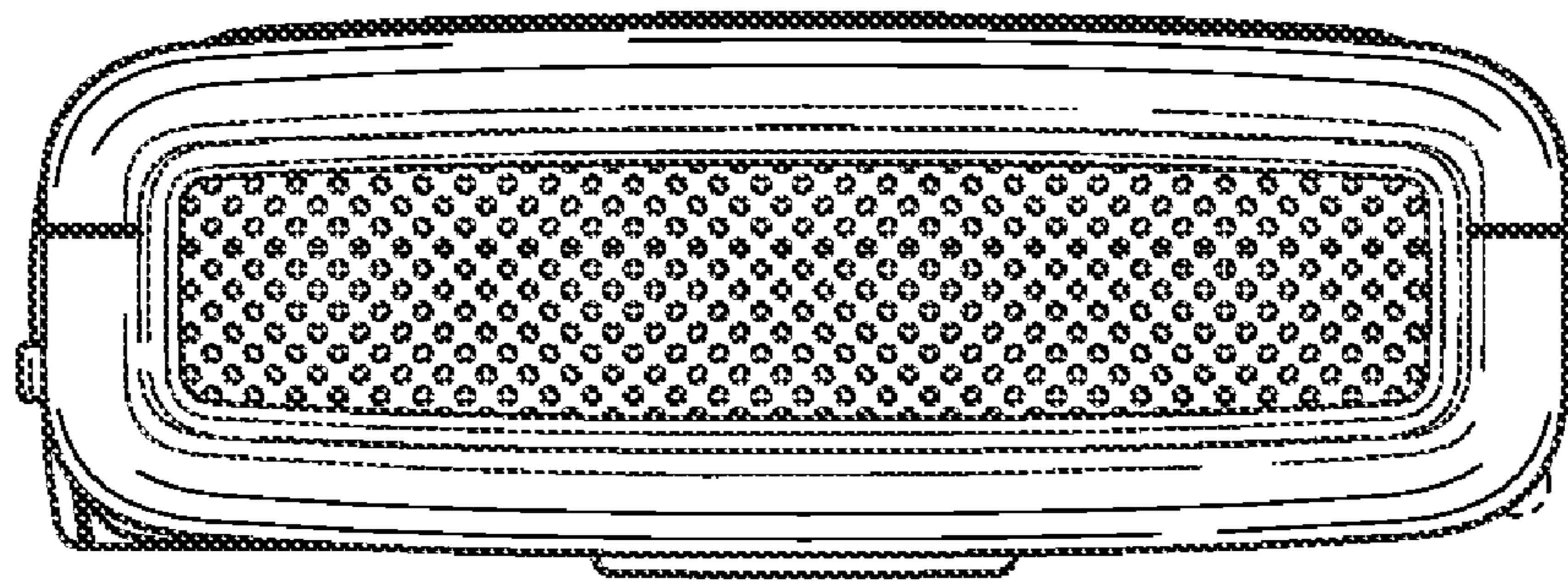

FIG. 7

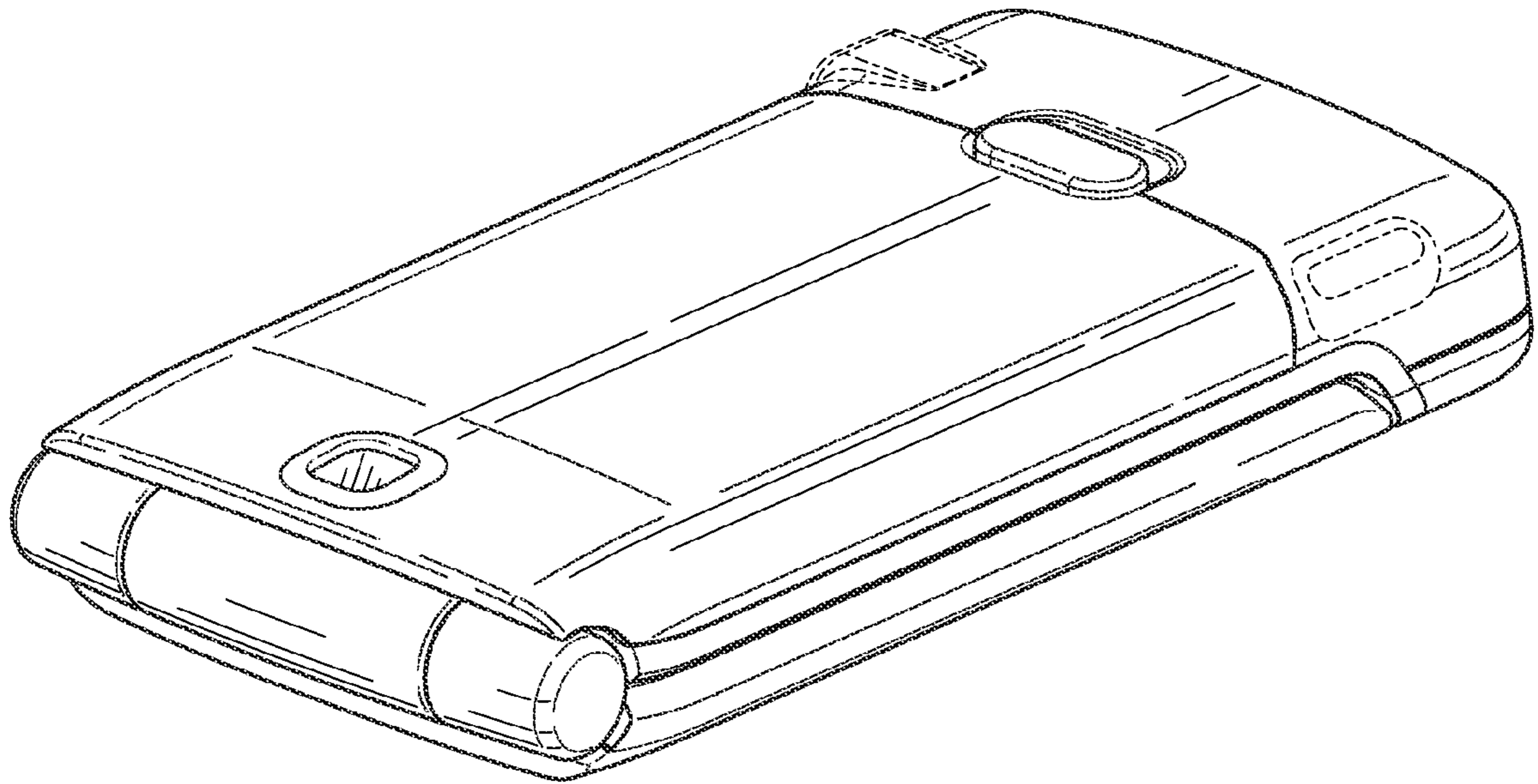

FIG. 8