



US00D587905S

(12) **United States Design Patent**
Wong

(10) **Patent No.:** **US D587,905 S**
(45) **Date of Patent:** **** Mar. 10, 2009**

(54) **TOOTHBRUSH WITH SUCTION CUP**

D458,757 S * 6/2002 Dunn et al. D4/104
D478,728 S * 8/2003 Wong D4/104

(75) Inventor: **Patrick Wong**, Beacon Hill (AU)

FOREIGN PATENT DOCUMENTS

(73) Assignee: **Barros Laboratories Pt Ltd**, New South Wales (AU)

KR 30-0288230 S * 12/2001
WO WO 9741753 A1 * 11/1997

(**) Term: **14 Years**

* cited by examiner

(21) Appl. No.: **29/267,836**

Primary Examiner—Melanie H Tung
Assistant Examiner—Lavone D Tabor

(22) Filed: **Oct. 23, 2006**

(74) *Attorney, Agent, or Firm*—Greer, Burns & Crain Ltd

(30) **Foreign Application Priority Data**

(57) **CLAIM**

Apr. 21, 2006 (AU) 11657/2006

The ornamental design for a toothbrush with suction cup, as shown and described.

(51) **LOC (9) Cl.** **04-02**

DESCRIPTION

(52) **U.S. Cl.** **D4/104**

(58) **Field of Classification Search** D4/104-112,
D4/134, 138; 15/110, 167.1, 167.2, 143.1,
15/207.2, DIG. 5; 16/430, 431; 132/308-310;
248/110, 683

FIG. 1 is a left side elevational view of a toothbrush with suction cup showing my new design.

See application file for complete search history.

FIG. 2 is a right side elevational view thereof.

(56) **References Cited**

U.S. PATENT DOCUMENTS

1,899,242 A * 2/1933 McNab 248/110
5,392,483 A * 2/1995 Heinzelman et al. 15/167.1
5,742,971 A * 4/1998 Salinger 15/167.1
D451,284 S * 12/2001 Moskovich et al. D4/104
6,349,445 B1 * 2/2002 Mackay et al. 15/167.1

FIG. 3 is a top plan view thereof.

FIG. 4 is a bottom plan view thereof.

FIG. 5 is an enlarged fragmentary perspective view of the suction cup end thereof;

FIG. 6 is a front side elevational view thereof; and,

FIG. 7 is a back side elevational view thereof.

1 Claim, 3 Drawing Sheets

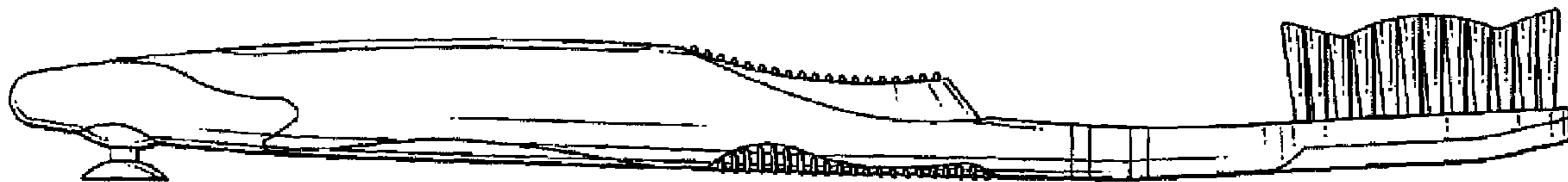

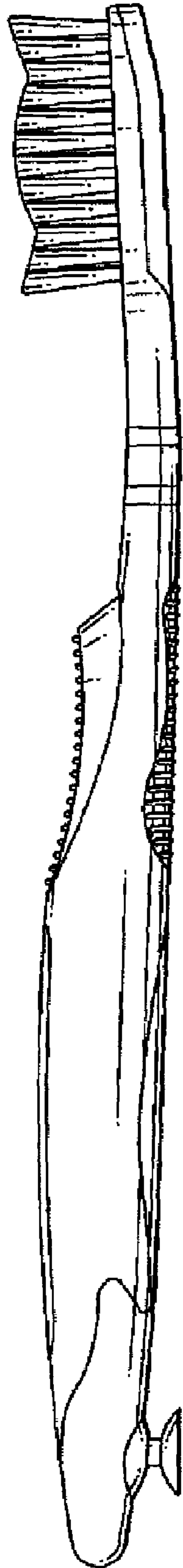

FIG. 1

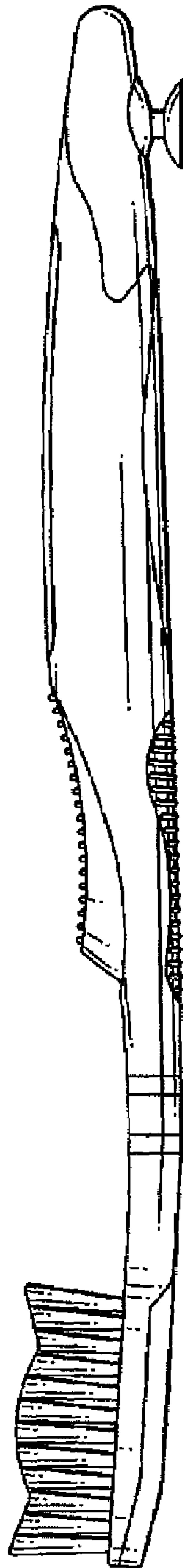

FIG. 2

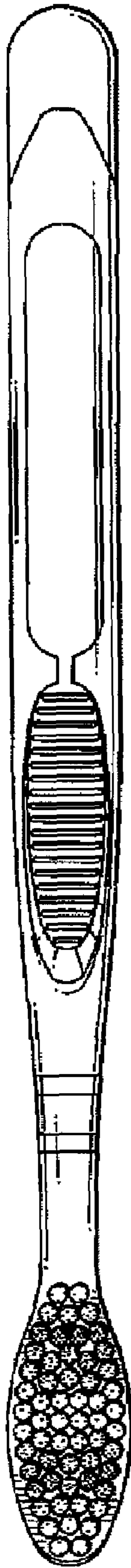

FIG. 3

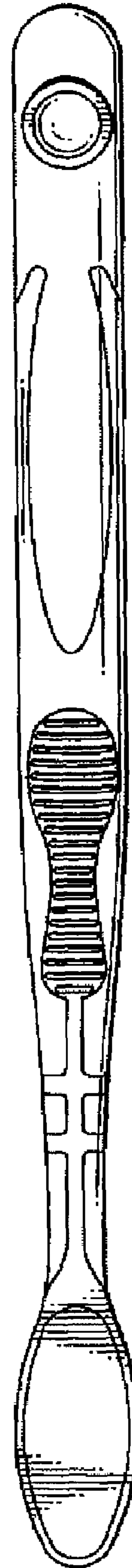

FIG. 4

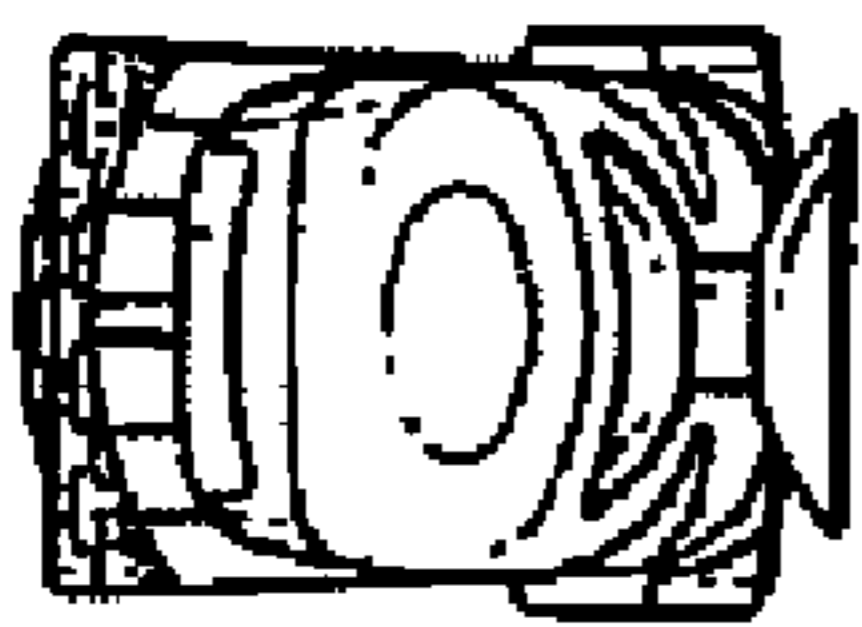

FIG. 7

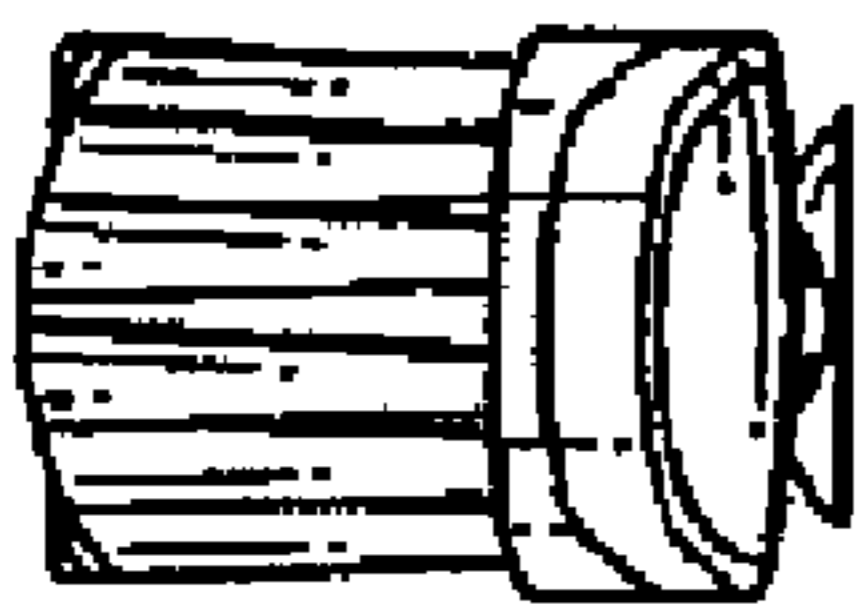

FIG. 6

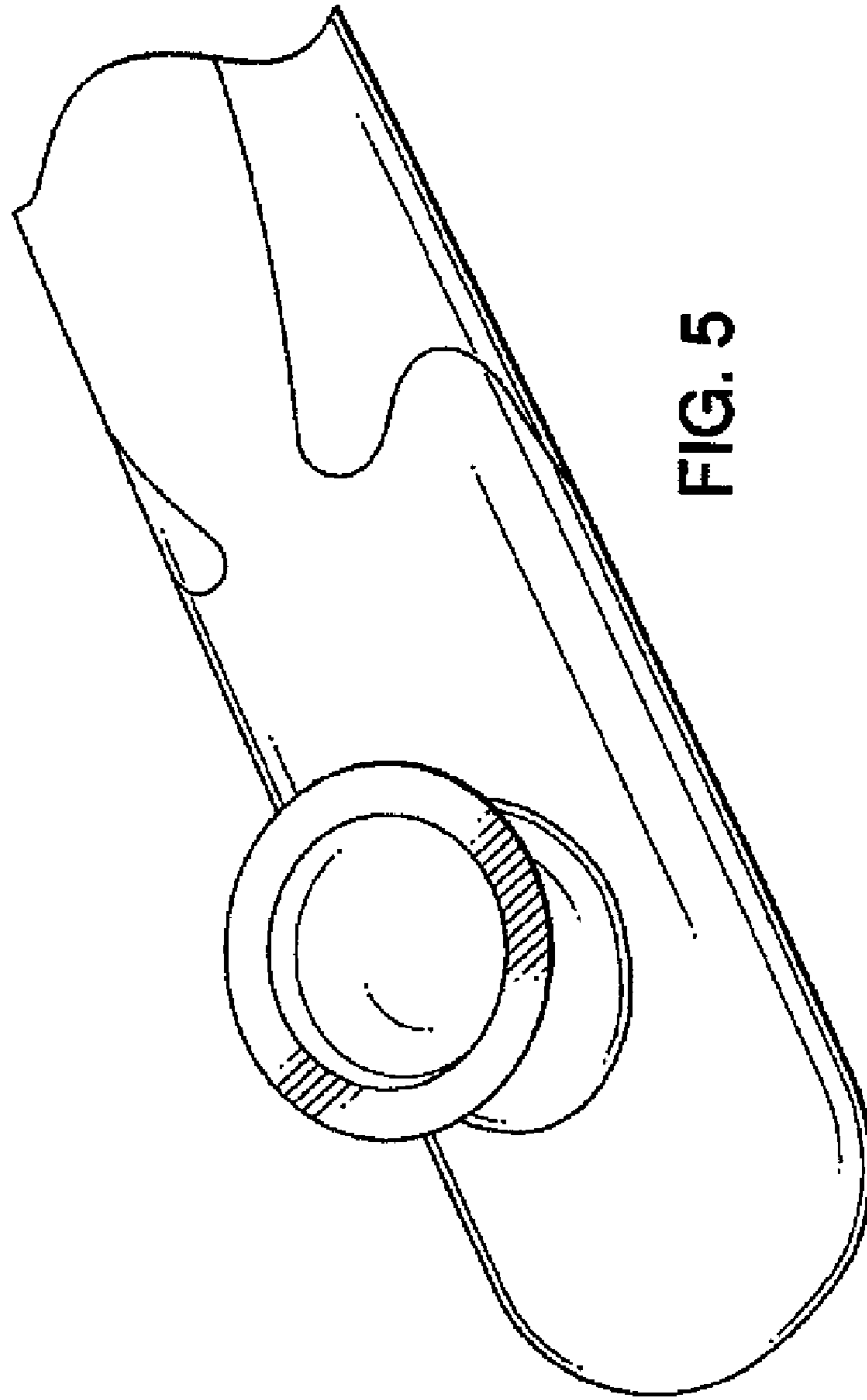

FIG. 5