



US00D587829S

(12) **United States Design Patent**  
**Wagner et al.**

(10) **Patent No.:** **US D587,829 S**  
(45) **Date of Patent:** **\*\* Mar. 3, 2009**

(54) **VEHICLE TAIL LAMP**

D553,268 S \* 10/2007 Pfeiffer ..... D26/28

(75) Inventors: **Lance R. Wagner**, Lake Orion, MI (US); **Mark C. Trostle**, Clarkston, MI (US); **Ryan C. Nagode**, West Bloomfield, MI (US)

\* cited by examiner

*Primary Examiner*—Marcus A. Jackson  
(74) *Attorney, Agent, or Firm*—Ralph E. Smith

(73) Assignee: **Chrysler LLC**, Auburn Hills, MI (US)

(57) **CLAIM**

(\*\*) Term: **14 Years**

The ornamental design for a vehicle tail lamp, as shown and described.

(21) Appl. No.: **29/323,444**

**DESCRIPTION**

(22) Filed: **Aug. 26, 2008**

**Related U.S. Application Data**

(63) Continuation-in-part of application No. 29/302,967, filed on Jan. 29, 2008.

FIG. 1 is a front perspective view of a vehicle tail lamp showing our new design;

(51) **LOC (9) Cl.** ..... **26-06**

(52) **U.S. Cl.** ..... **D26/28**

FIG. 2 is a rear perspective view thereof;

(58) **Field of Classification Search** ..... D26/28-36;  
362/459-468, 475-478, 485-487

FIG. 3 is a rear view thereof;

See application file for complete search history.

FIG. 4 is a front view thereof;

FIG. 5 is a top view thereof;

FIG. 6 is a bottom view thereof;

FIG. 7 is a right side view thereof; and,

FIG. 8 is a left side view thereof.

(56) **References Cited**

It will be understood that the broken lines presented in the drawings are for illustration only, and do not form a part of the claimed design.

**U.S. PATENT DOCUMENTS**

D549,363 S \* 8/2007 Pfeiffer ..... D26/28  
D552,769 S \* 10/2007 Leclercq ..... D26/28

**1 Claim, 8 Drawing Sheets**

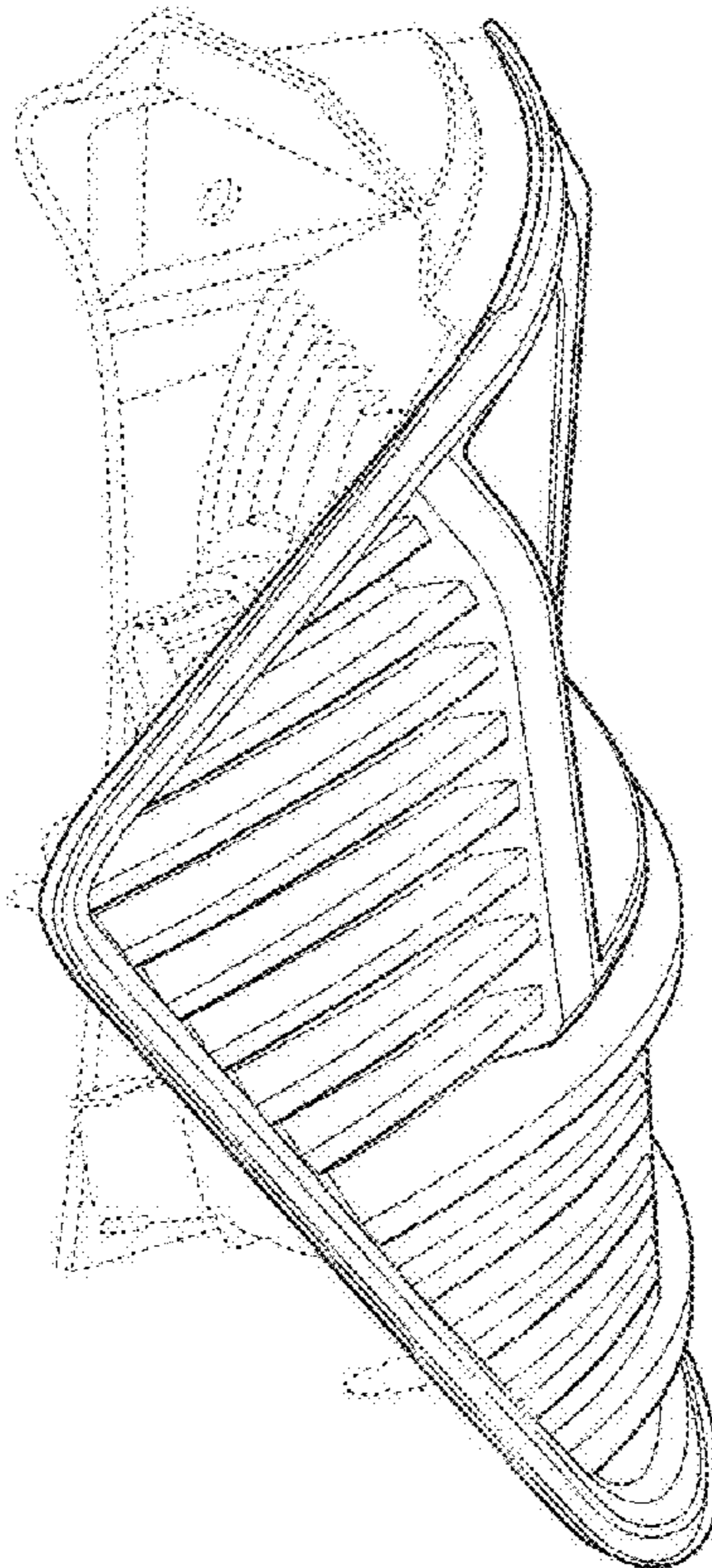

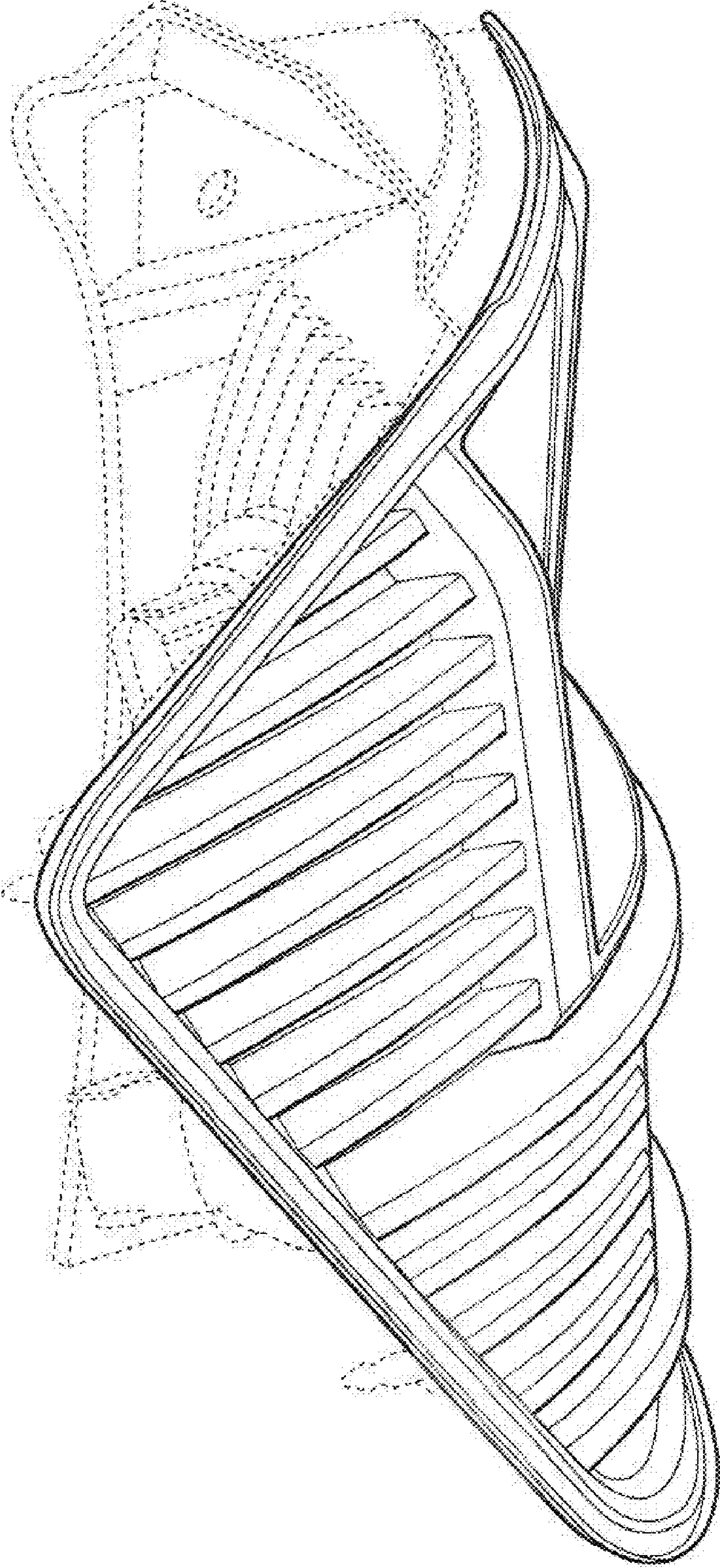

FIG. 1



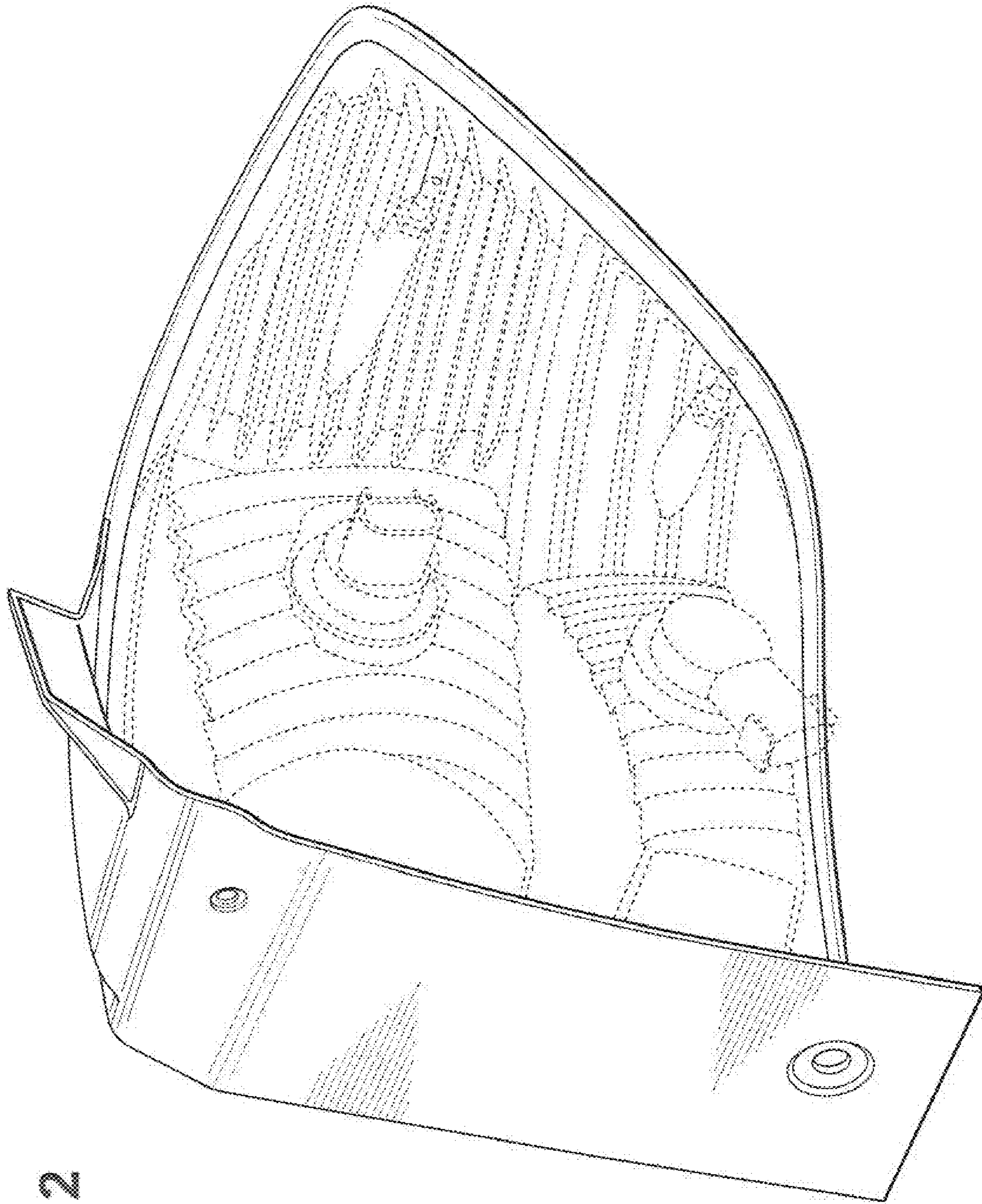

FIG. 2

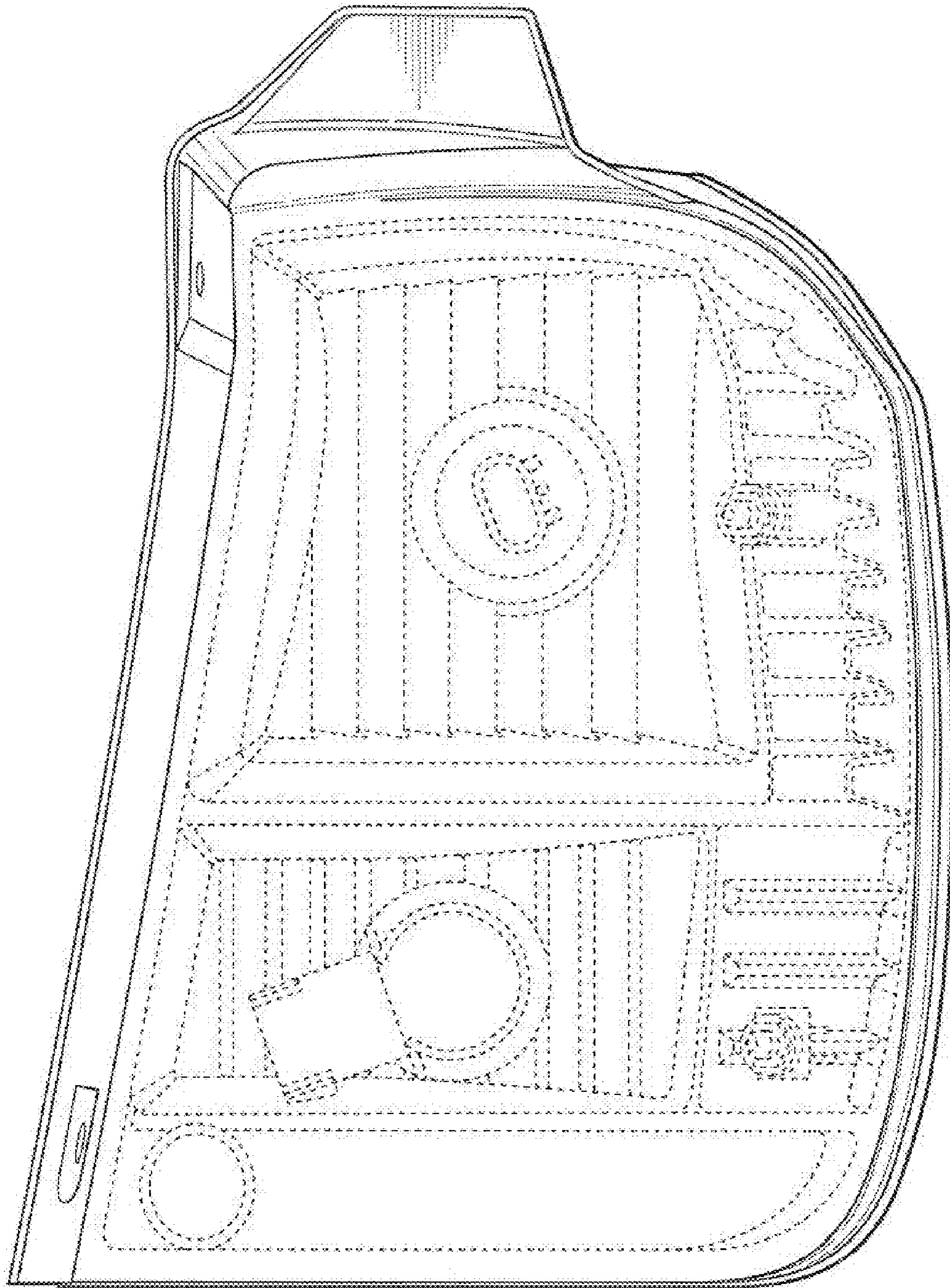

FIG. 3



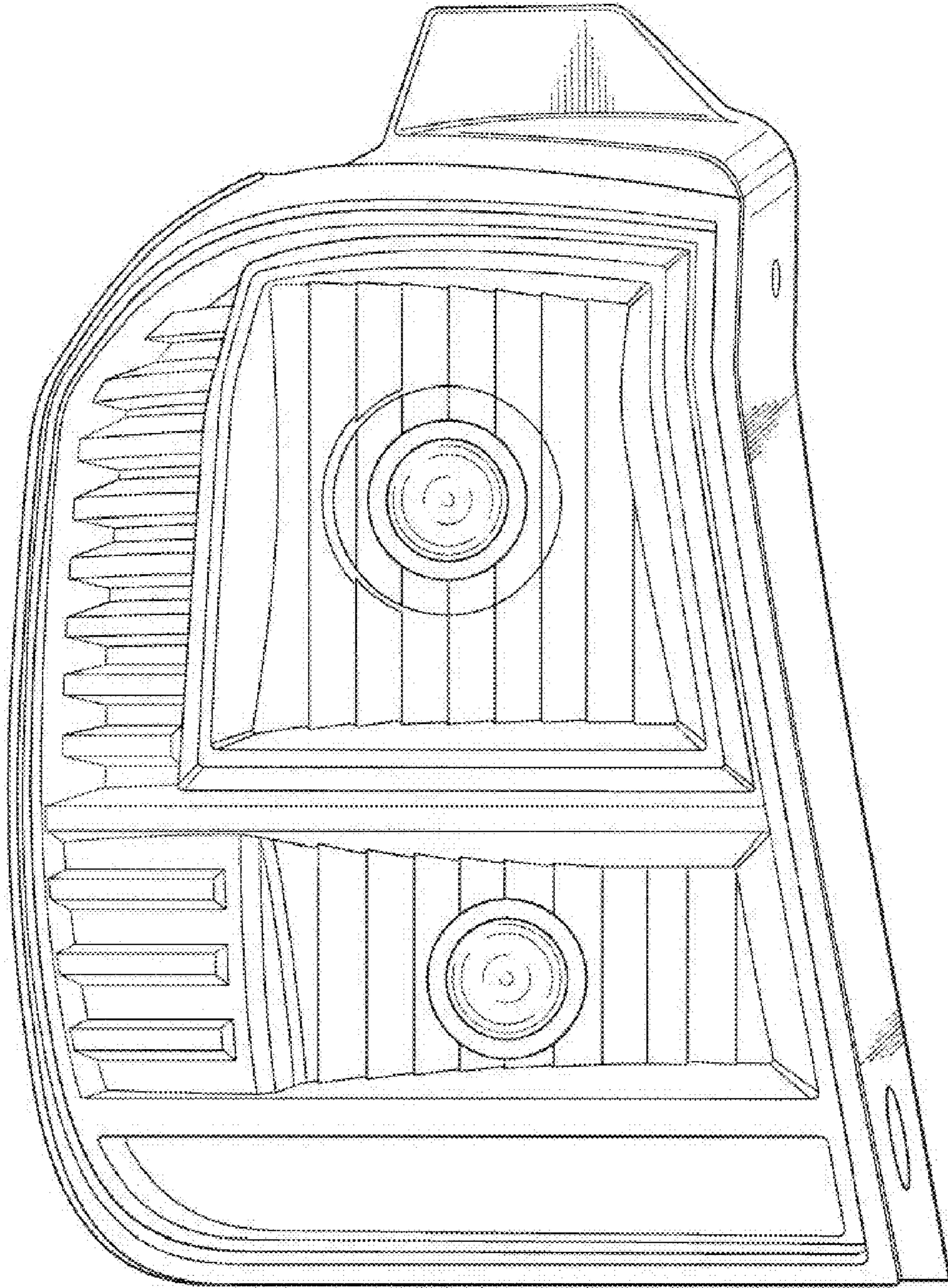

FIG. 4

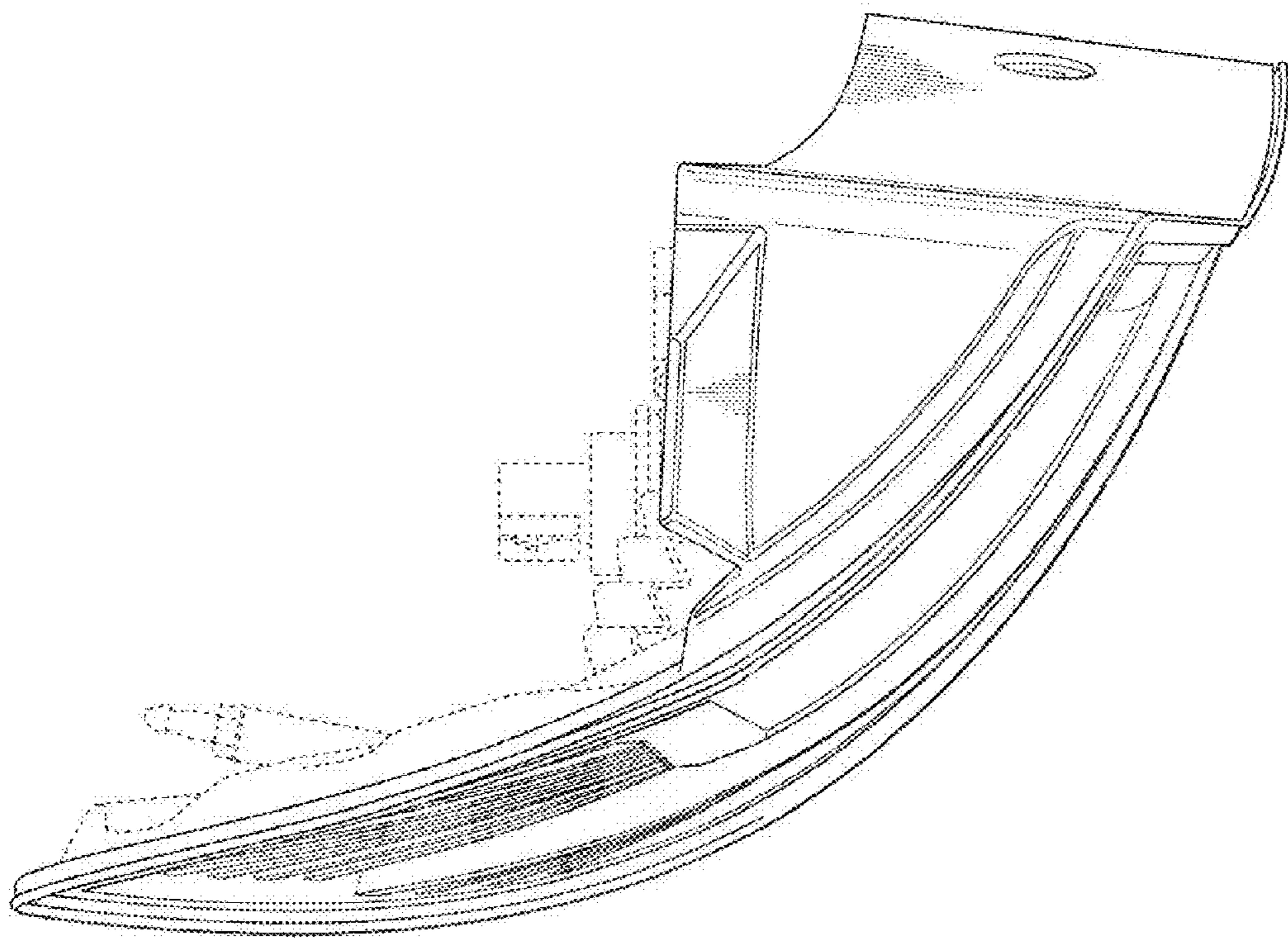

FIG. 5

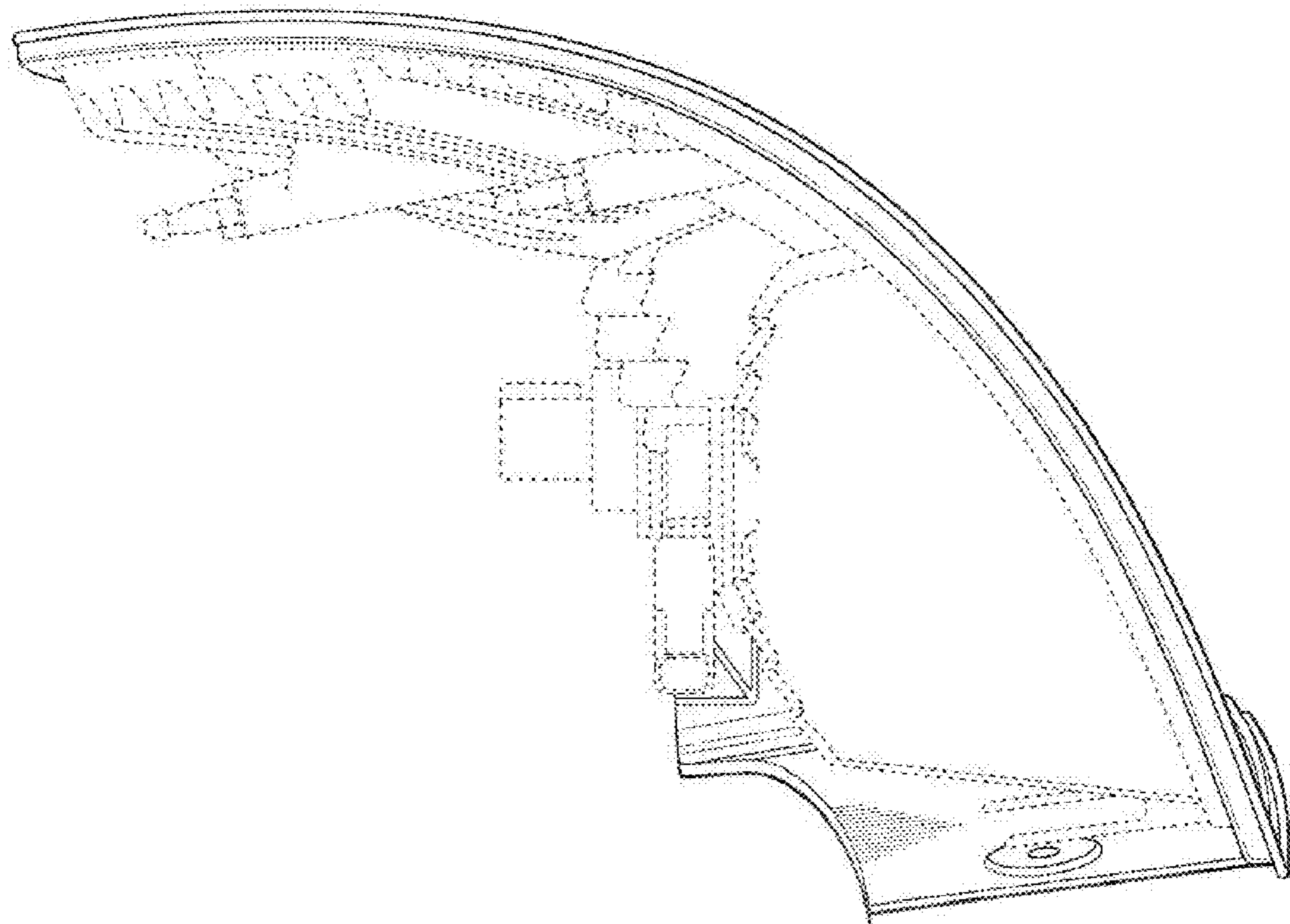

FIG. 6



FIG. 7

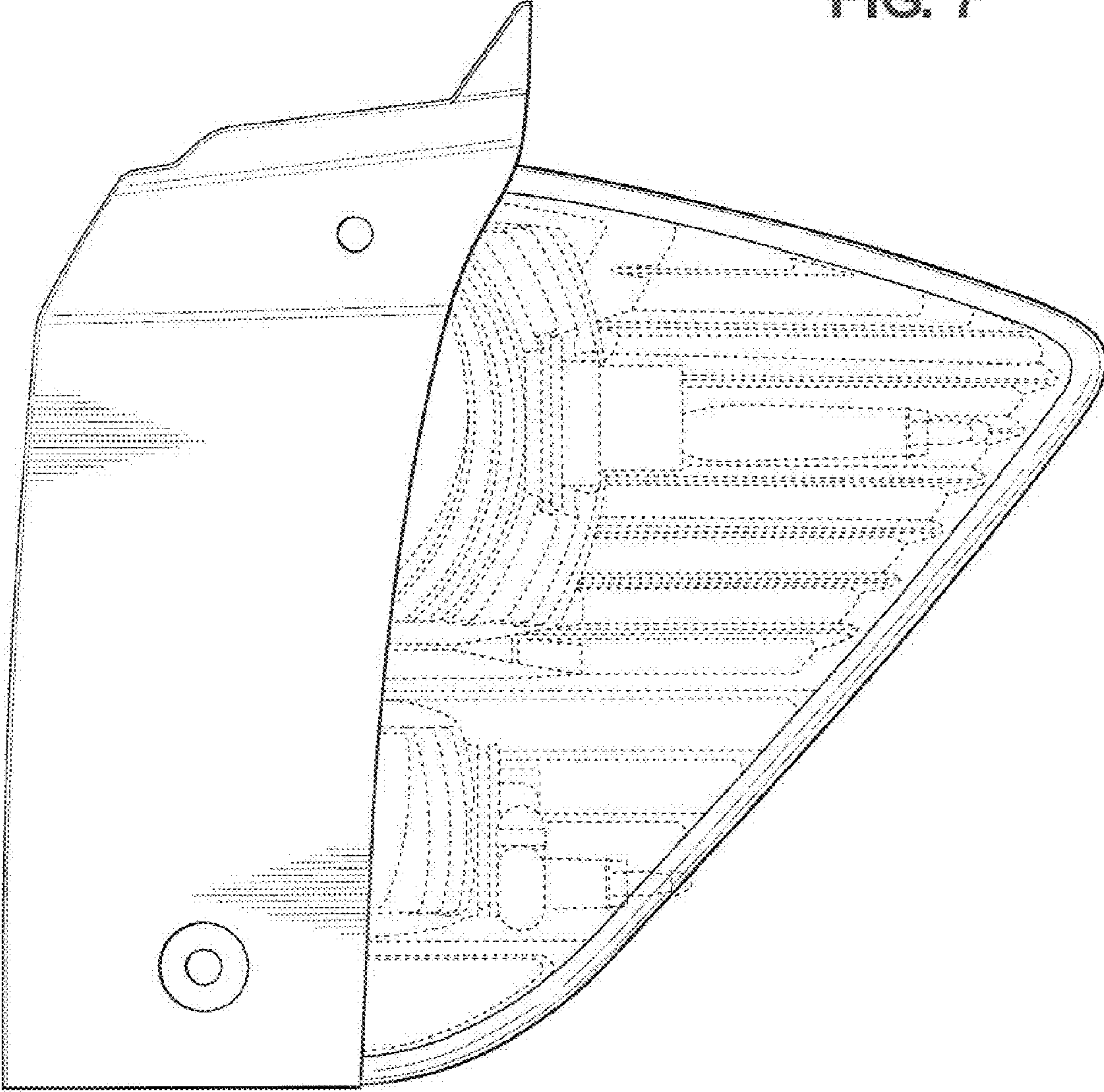



FIG. 8

