



US00D587746S

(12) **United States Design Patent**  
**Russo et al.**

(10) **Patent No.:** **US D587,746 S**  
(45) **Date of Patent:** **\*\* Mar. 3, 2009**

(54) **STAMPING TOOL**

(75) Inventors: **Peter Russo**, Bedford, MA (US);  
**Douglas Nelson**, Madison, WI (US);  
**Rebecca Lidstrom**, Madison, WI (US);  
**Julia Dorn**, Sun Prairie, WI (US); **Carl**  
**Dana Hardy**, Medfield, MA (US)

(73) Assignee: **Fiskars Brands, Inc.**, Madison, WI (US)

(\*\*) Term: **14 Years**

(21) Appl. No.: **29/319,517**

(22) Filed: **Jun. 10, 2008**

(51) **LOC (9) Cl.** ..... **19-02**

(52) **U.S. Cl.** ..... **D18/15**

(58) **Field of Classification Search** ..... D18/15,  
D18/16, 17, 18, 50; 101/333, 334, 327, 328,  
101/352.07, 405, 406; 118/264, 268

See application file for complete search history.

(56) **References Cited**

U.S. PATENT DOCUMENTS

1,512,085	A	10/1924	Clary	
2,222,333	A	11/1940	Wenzel et al.	
D367,290	S *	2/1996	Sculler et al.	D18/15
5,505,130	A	4/1996	Winston	
5,636,569	A	6/1997	Winston	
5,809,886	A	9/1998	Faber	
5,870,953	A	2/1999	Winston	
5,909,709	A	6/1999	An et al.	
D427,233	S *	6/2000	Faber	D18/15
6,189,450	B1 *	2/2001	Shih	101/333
D444,808	S *	7/2001	Dour et al.	D18/15
D451,945	S *	12/2001	MacNeil et al.	D18/15
D452,262	S *	12/2001	MacNeil et al.	D18/15
D492,957	S *	7/2004	Wei	D18/15
D493,191	S *	7/2004	Sculler et al.	D18/15
D493,192	S *	7/2004	Sculler et al.	D18/15
6,761,114	B2	7/2004	Koneczny et al.	
6,796,230	B2	9/2004	Pichler et al.	
6,834,584	B1 *	12/2004	MacNeil	101/333
6,892,638	B2	5/2005	Sculler	
6,945,172	B1 *	9/2005	Shih	101/333
D513,037	S *	12/2005	Faber	D18/15
D518,087	S *	3/2006	Shih	D18/15
D518,506	S *	4/2006	Faber	D18/15

7,077,063	B2	7/2006	Petersen	
7,086,331	B2	8/2006	Moody	
D545,352	S *	6/2007	Treml	D18/15
D550,280	S	9/2007	Russo et al.	
7,389,727	B2 *	6/2008	Faber	101/334
2006/0000374	A1	1/2006	Faber	

OTHER PUBLICATIONS

<http://www.staples.com/office/supplies/StaplesSearch?searchkey=stamp+kits&storeId=10001&catalogId=10051&landId=-1&fromUrl=home>.

\* cited by examiner

*Primary Examiner*—Charles A. Rademaker

(74) *Attorney, Agent, or Firm*—Foley & Lardner LLP

(57) **CLAIM**

We claim the ornamental design for a stamping tool, as shown and described.

**DESCRIPTION**

FIG. 1 is a perspective view of a stamping tool showing our new design;

FIG. 2 is a front elevation thereof;

FIG. 3 is a right side elevation thereof;

FIG. 4 is a left side elevation thereof;

FIG. 5 is a rear elevation thereof;

FIG. 6 is a top plan view thereof;

FIG. 7 is a bottom plan view thereof;

FIG. 8 is a perspective view of a modified embodiment of the design shown in FIGS. 1 through 7;

FIG. 9 is a front elevation thereof;

FIG. 10 is a right side elevation thereof;

FIG. 11 is a left side elevation thereof;

FIG. 12 is a rear elevation thereof;

FIG. 13 is a top plan view thereof; and,

FIG. 14 is a bottom plan view thereof.

The broken lines shown in the drawings are included for purposed of illustration and form no part of the claimed design.

**1 Claim, 8 Drawing Sheets**

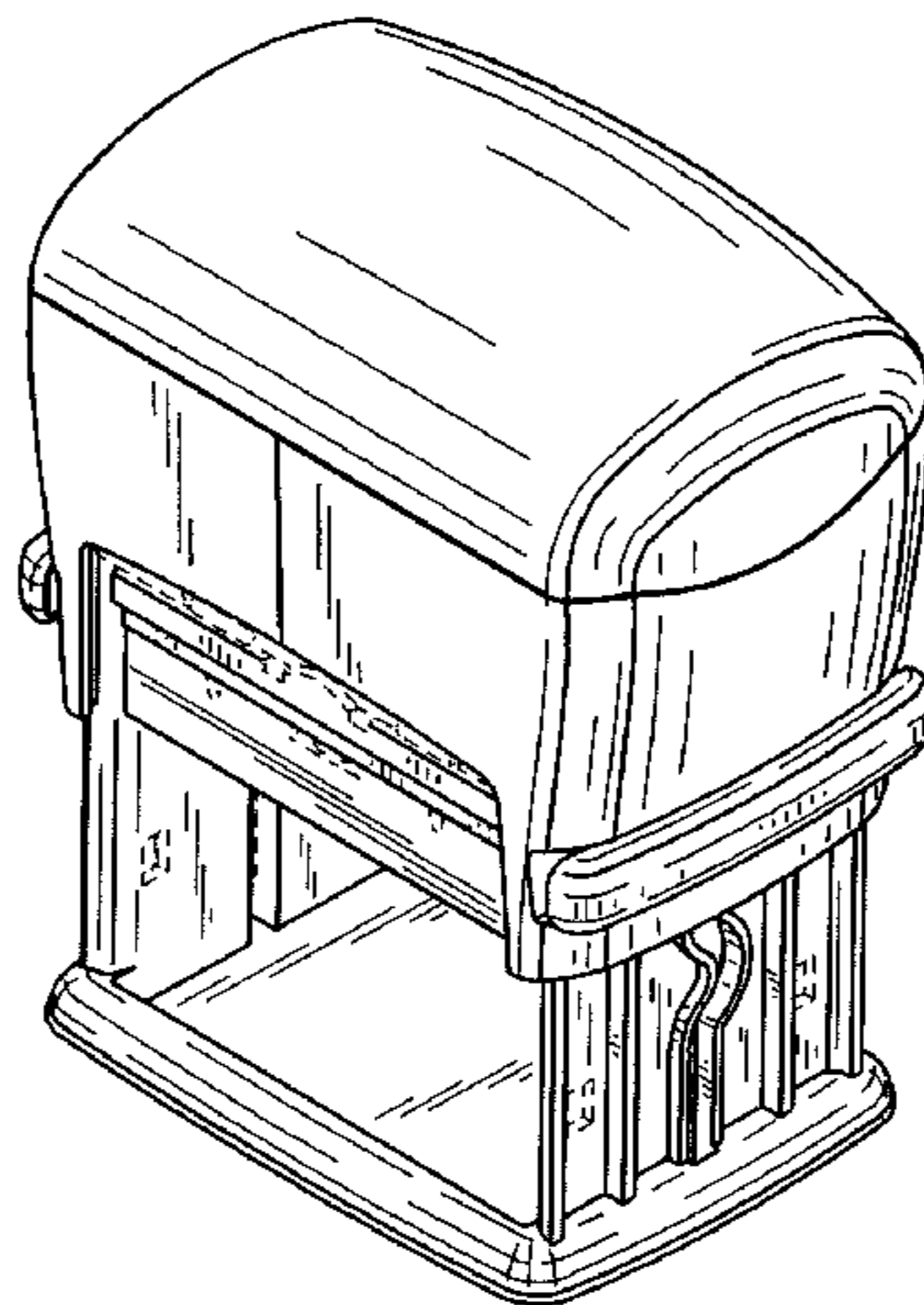

FIG. 1

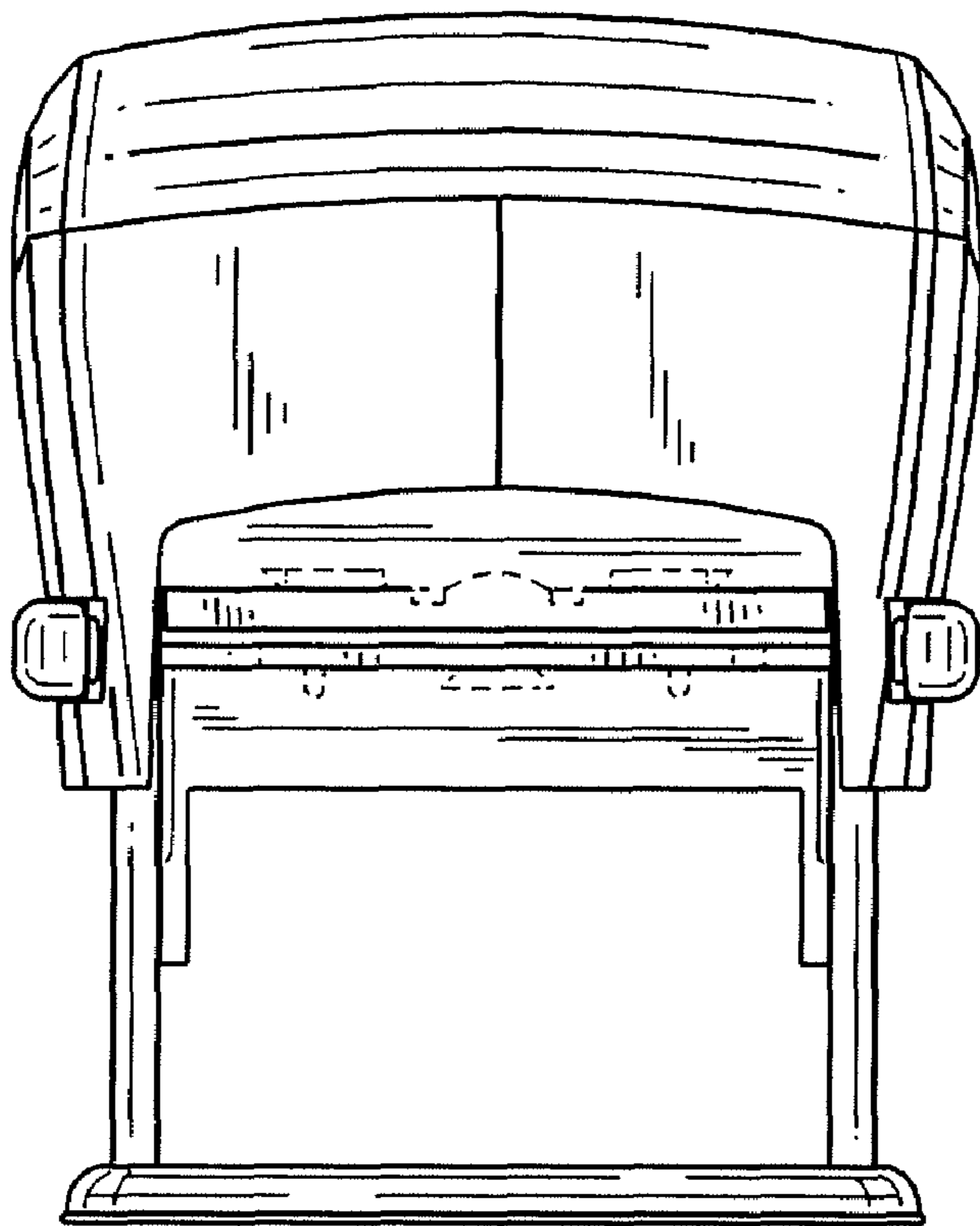
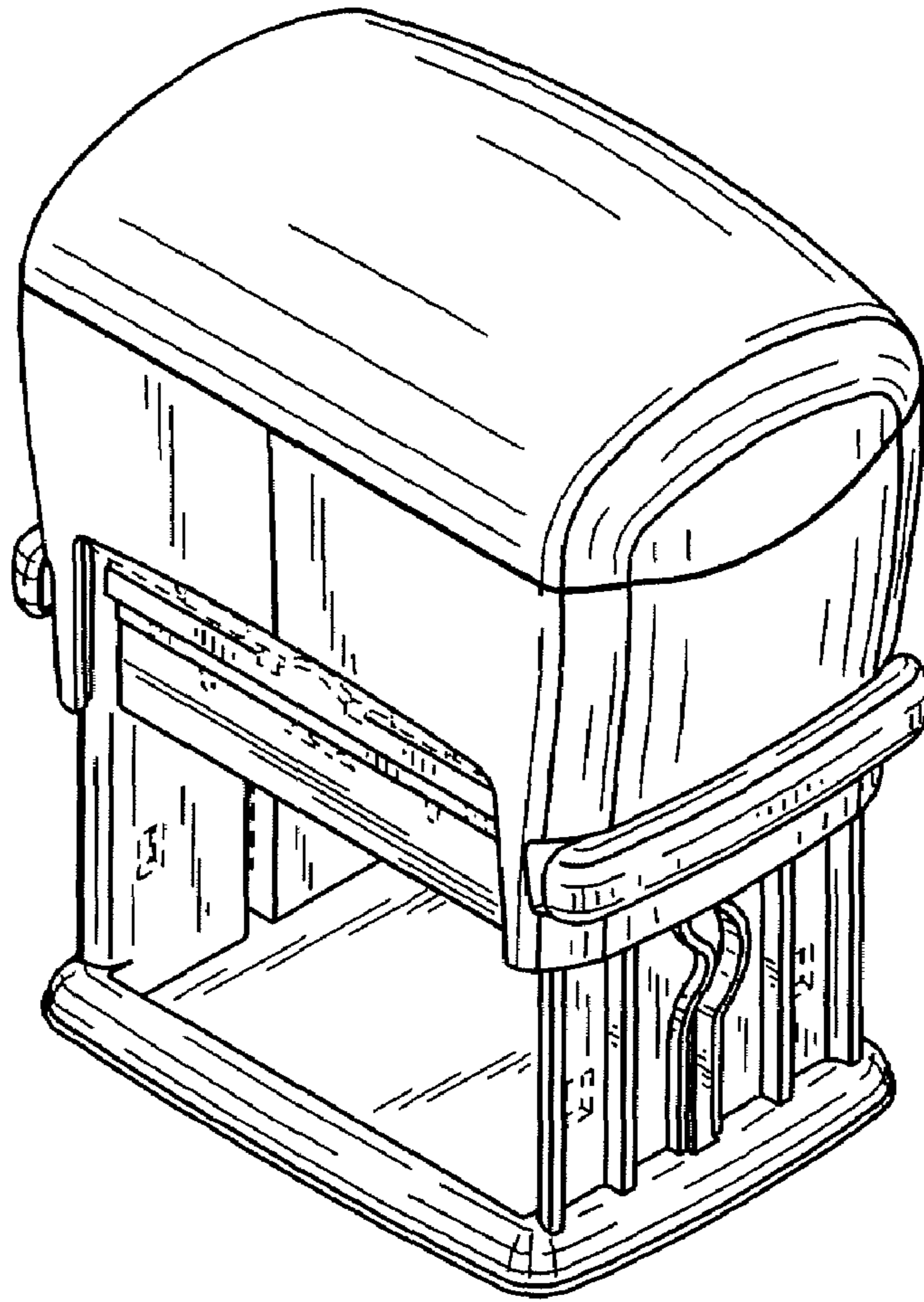

FIG. 2

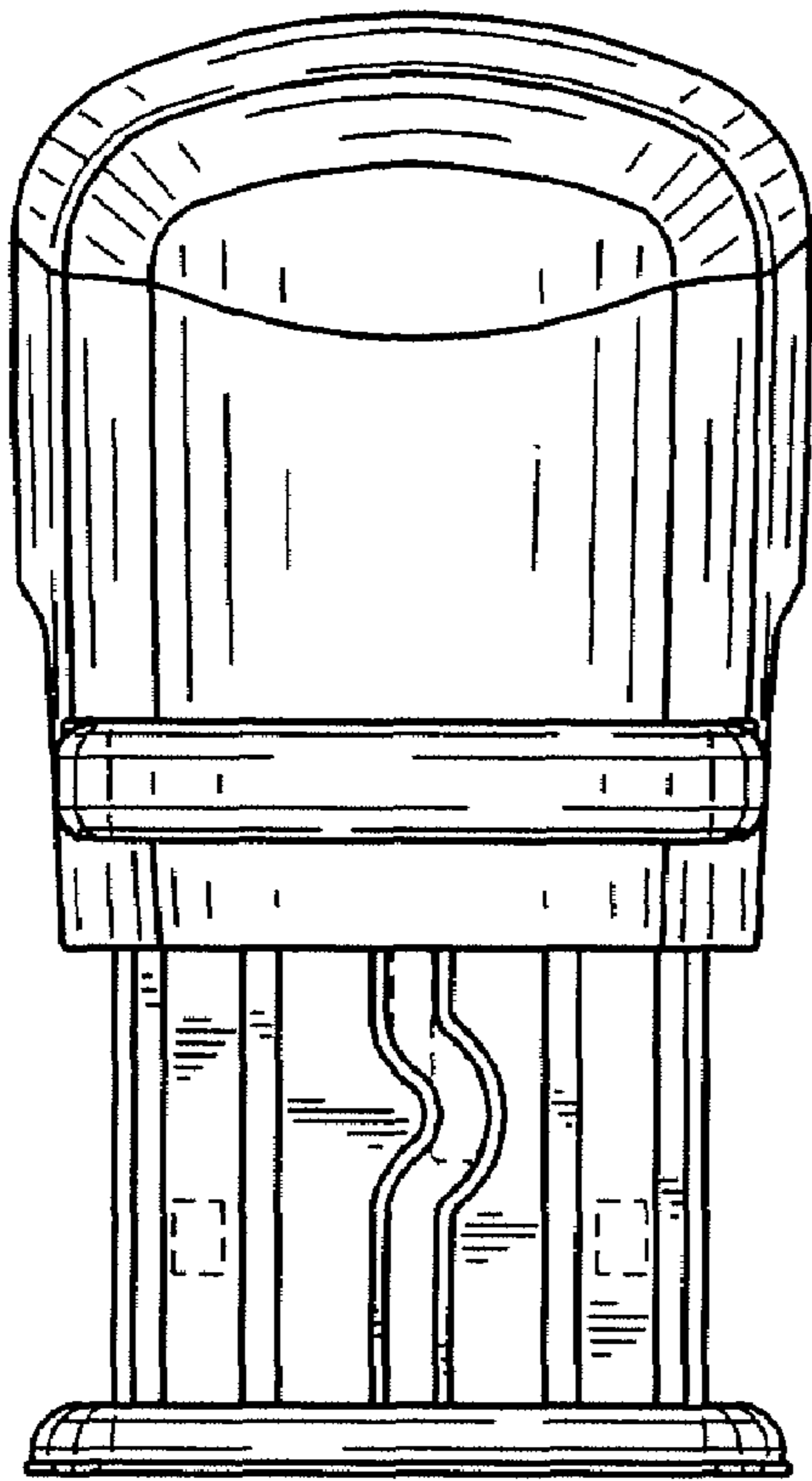
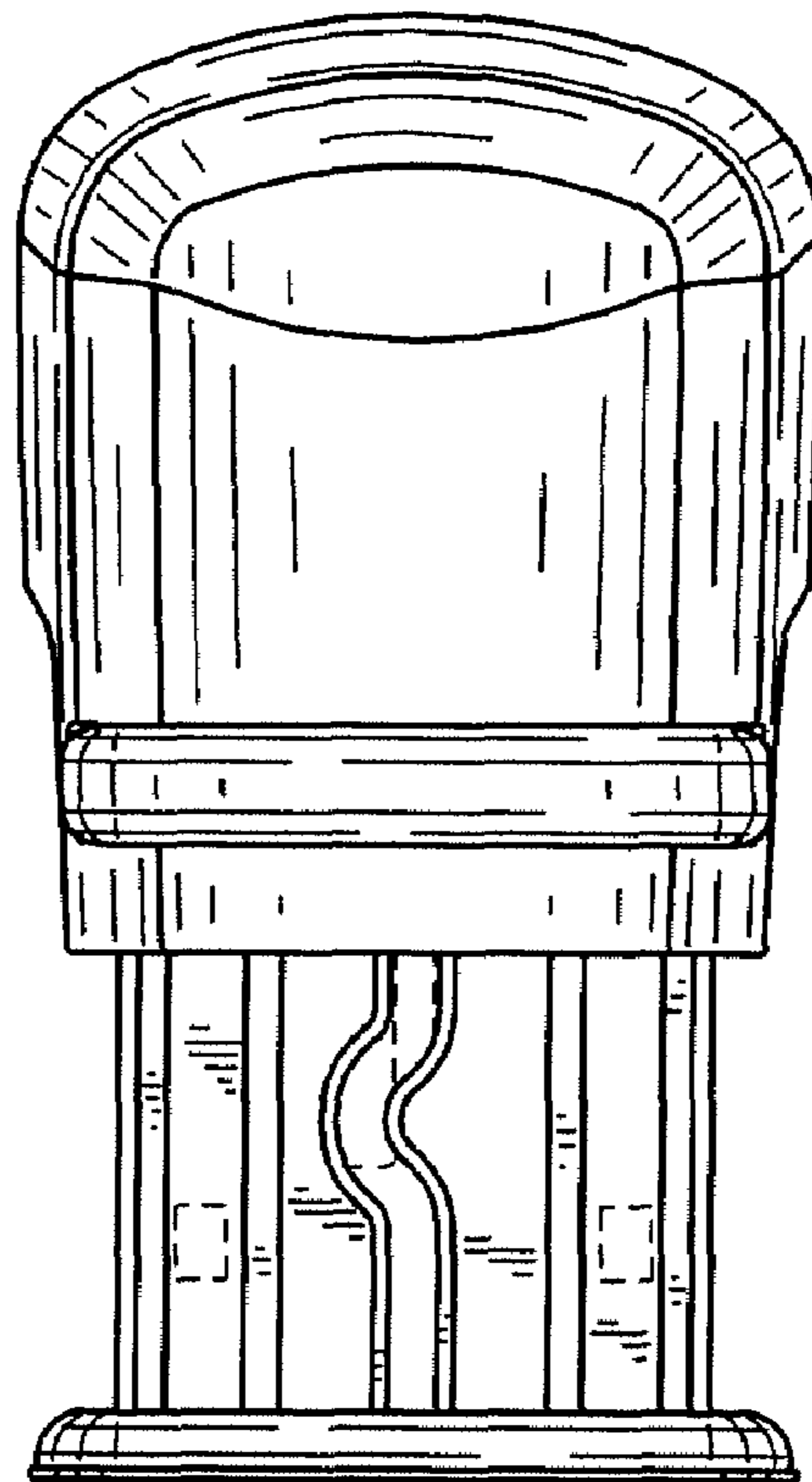

FIG. 3

FIG. 4



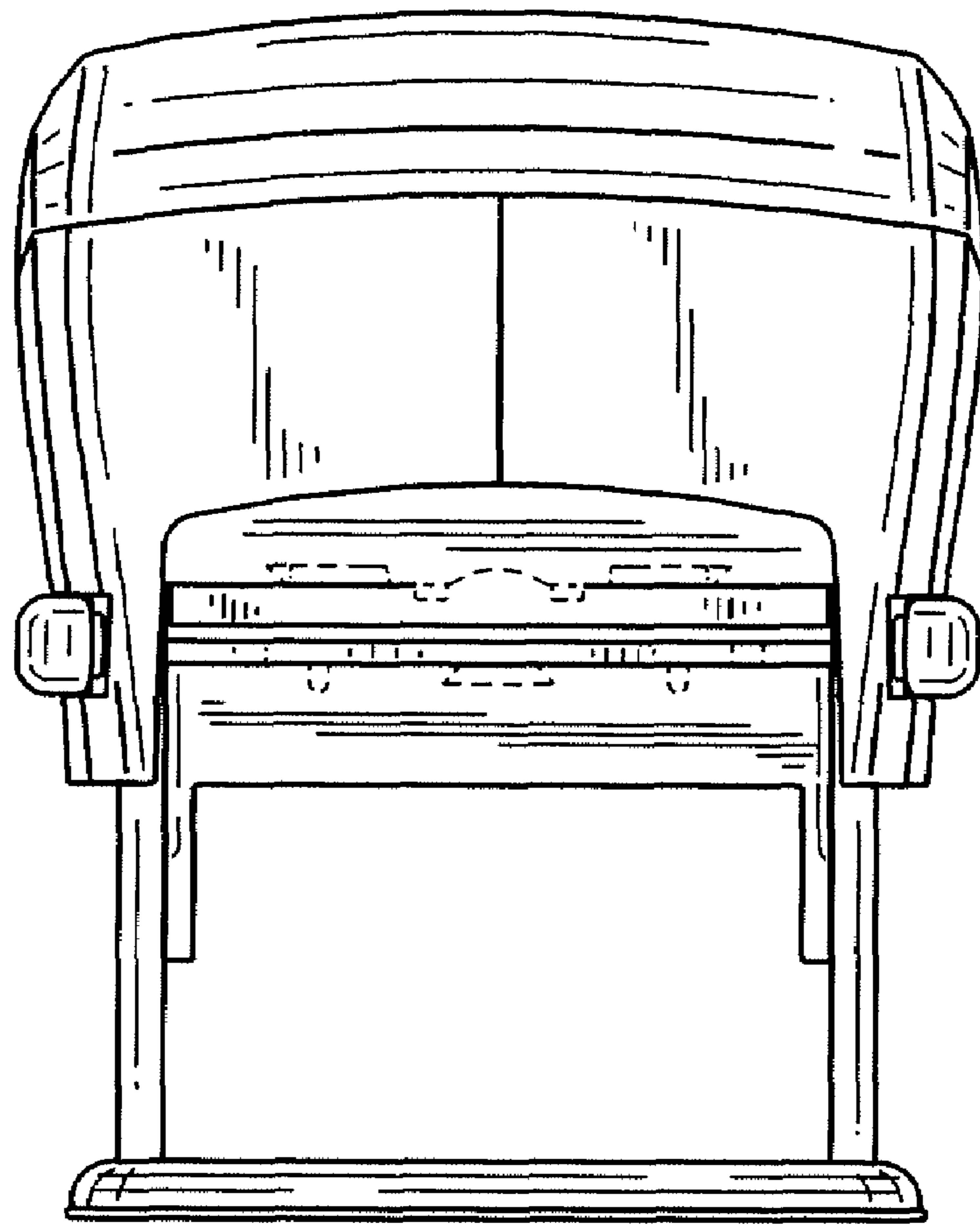

FIG. 5

FIG. 6

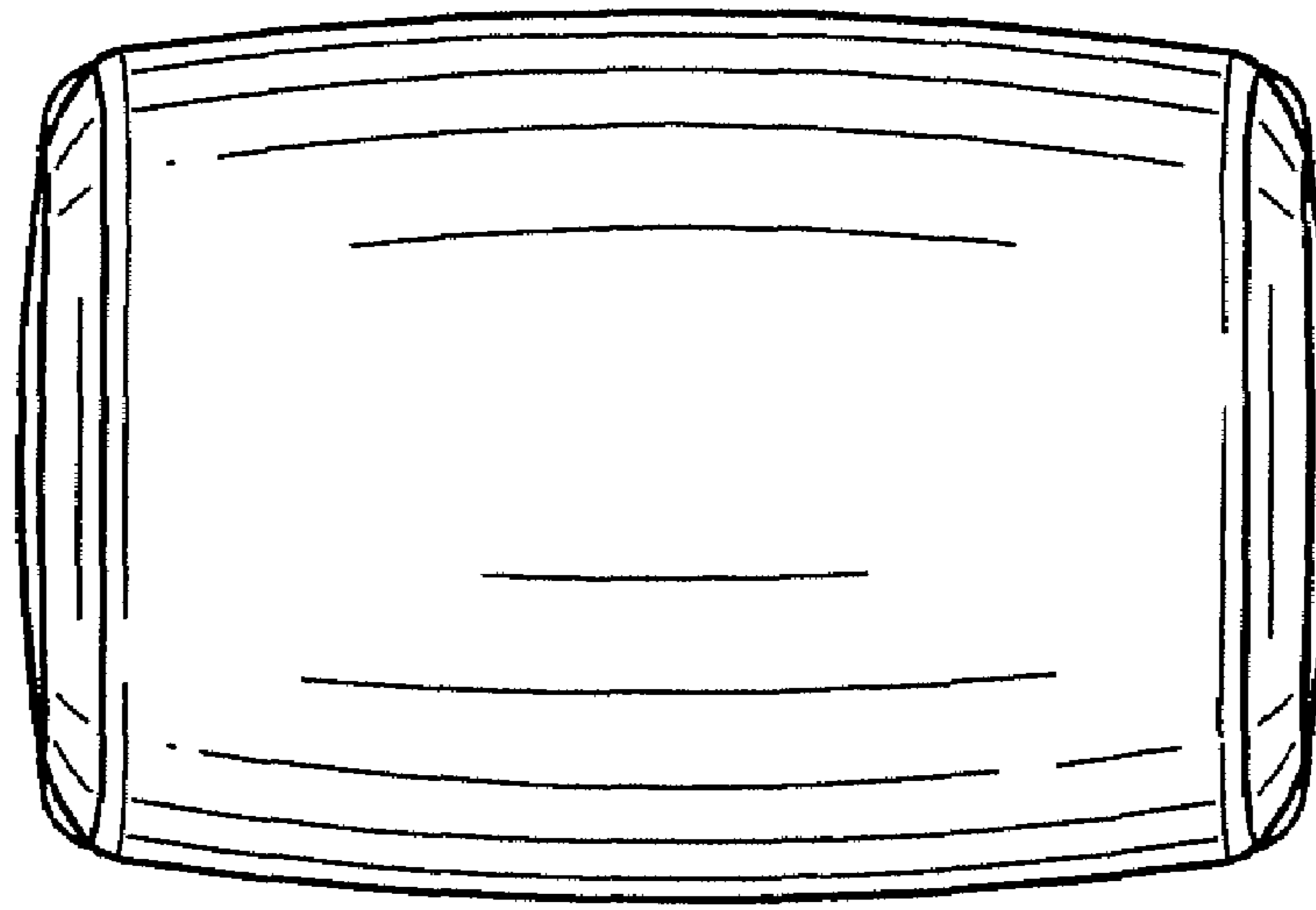
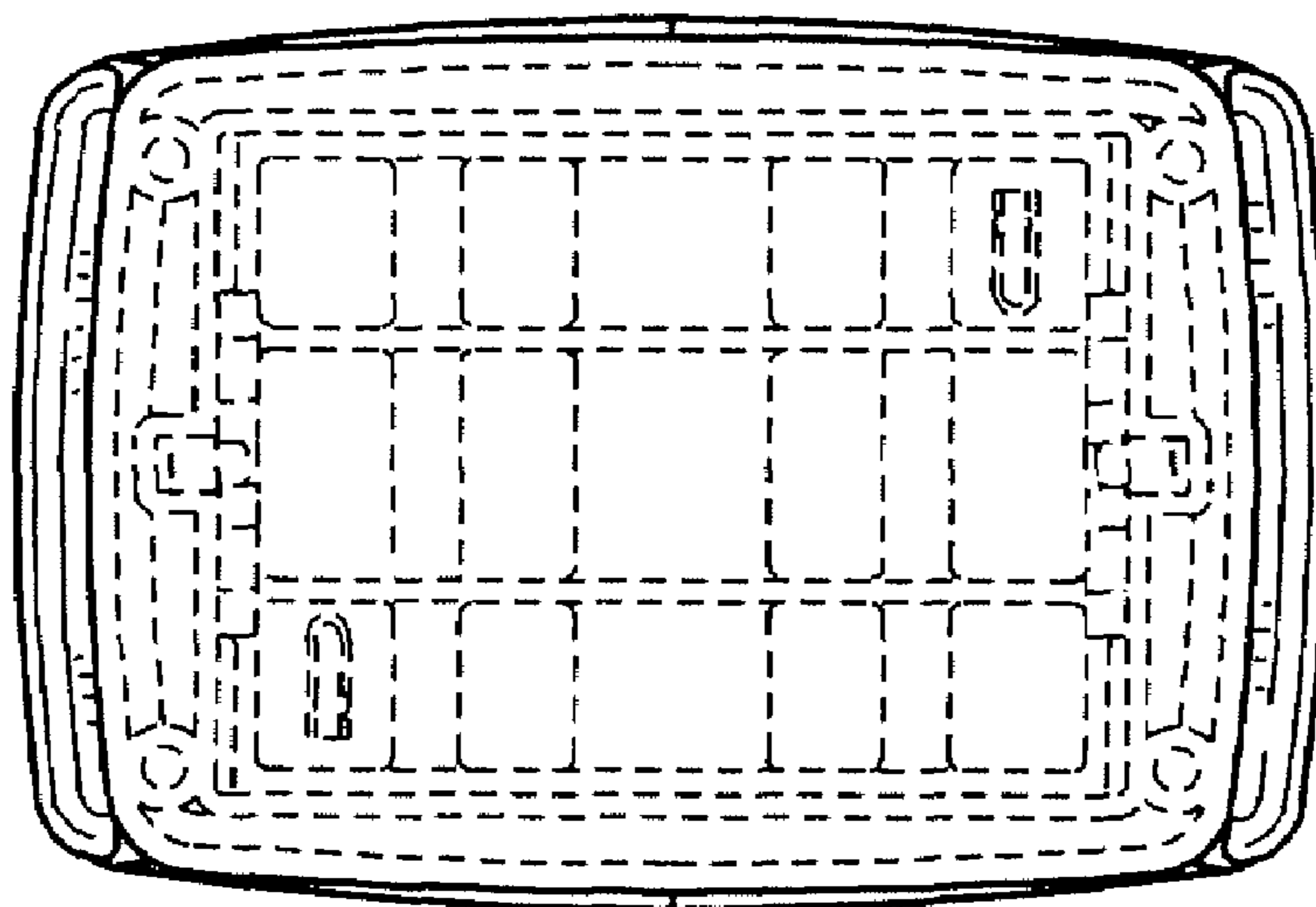

FIG. 7



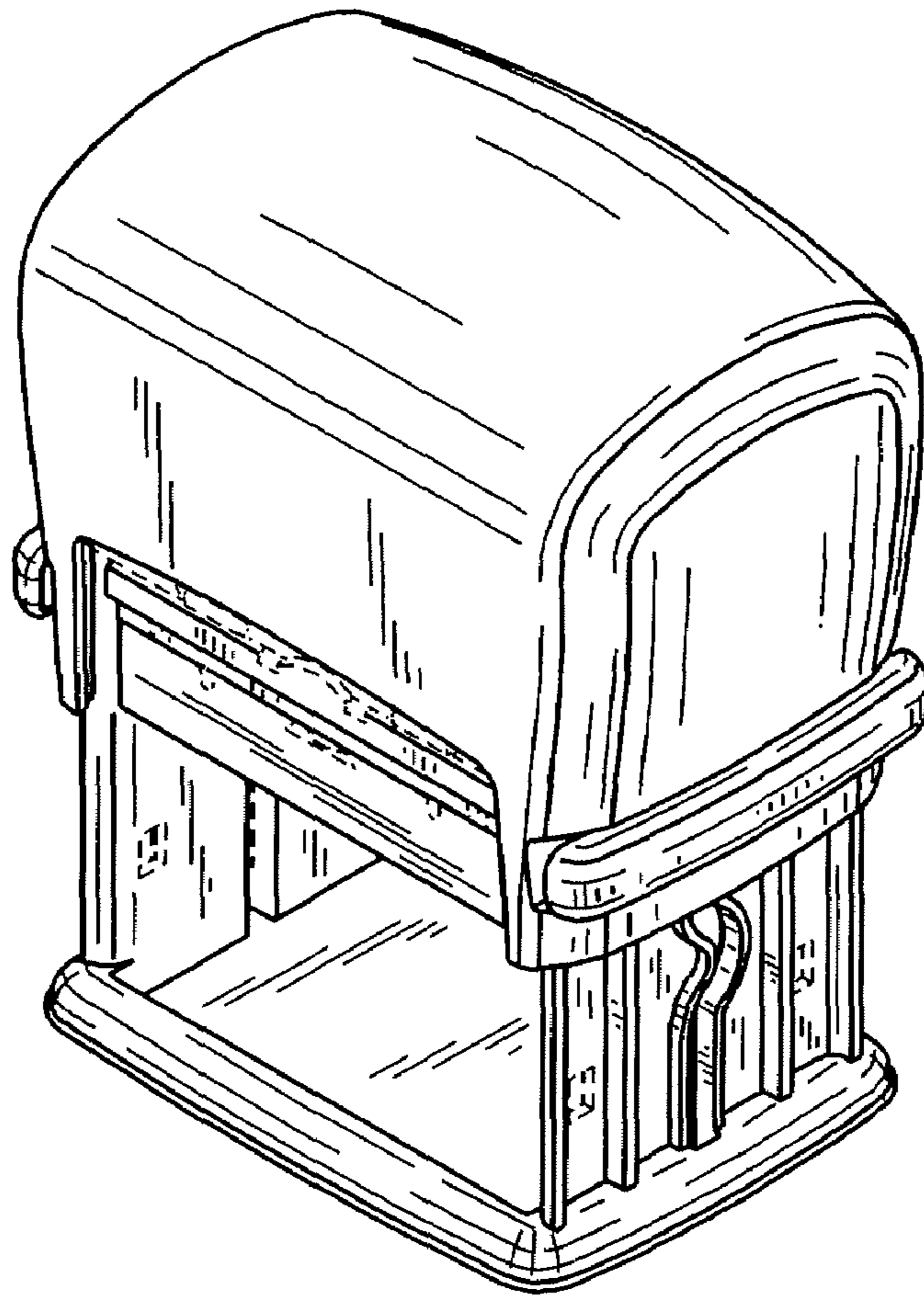

FIG. 8

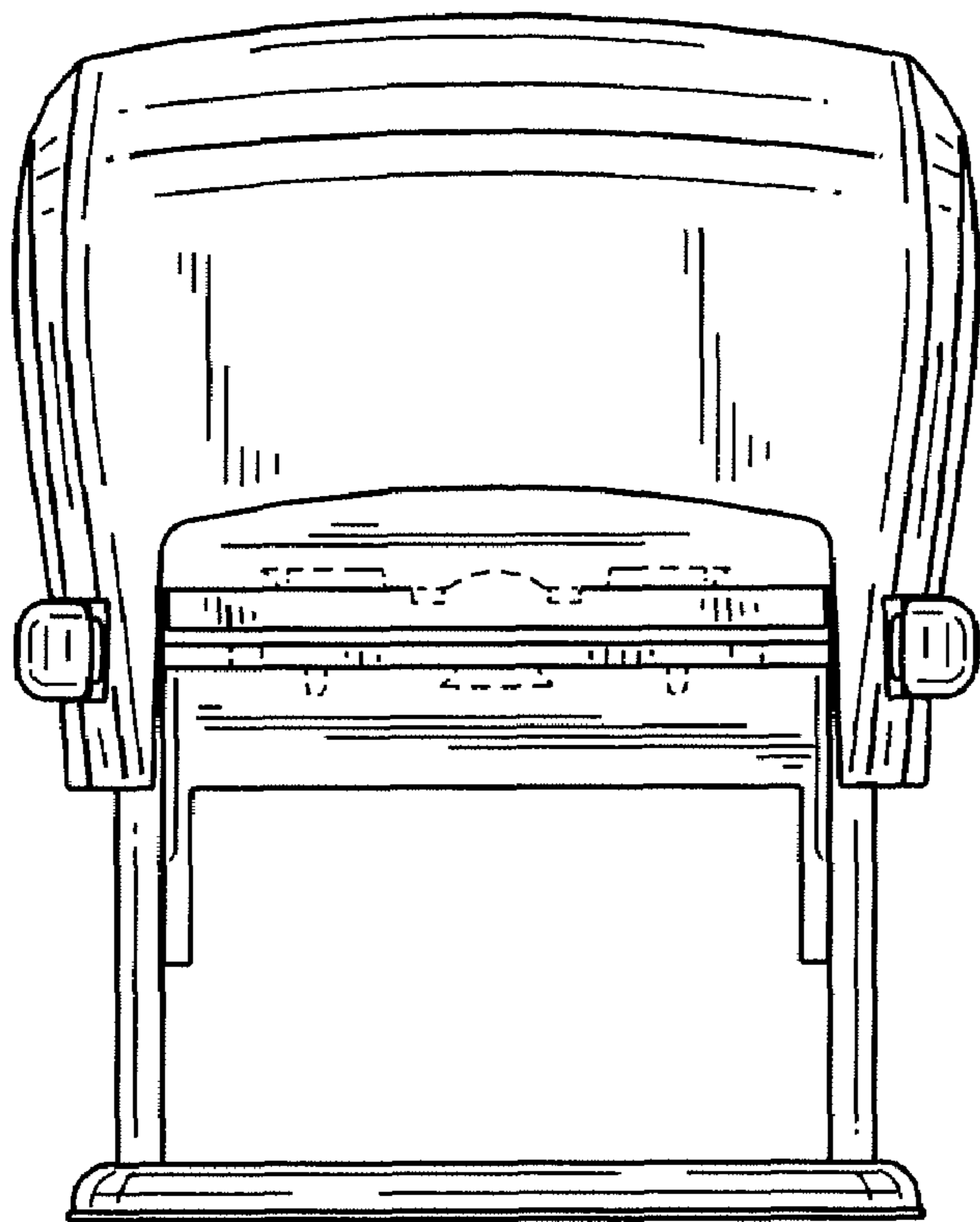

FIG. 9

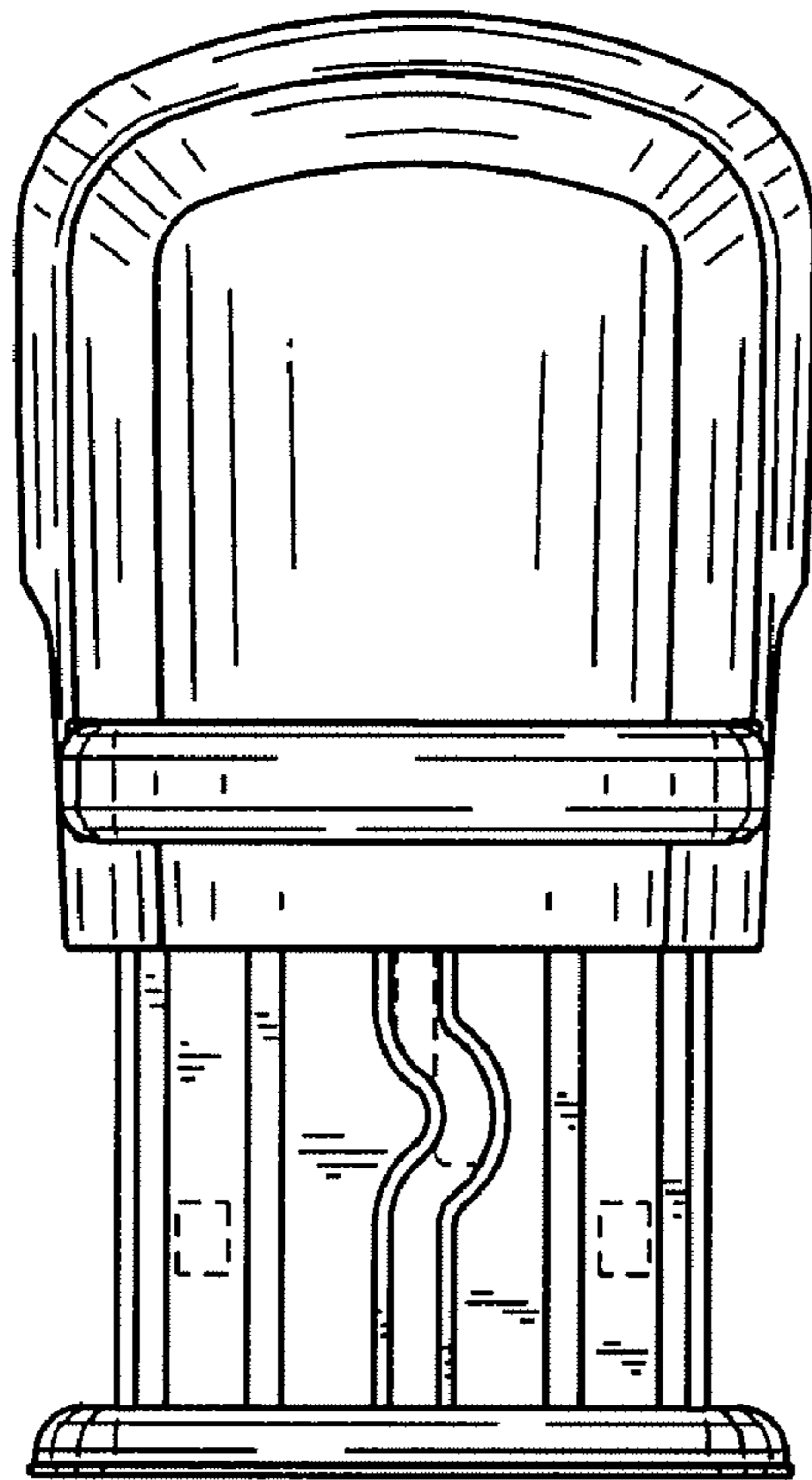

FIG. 10

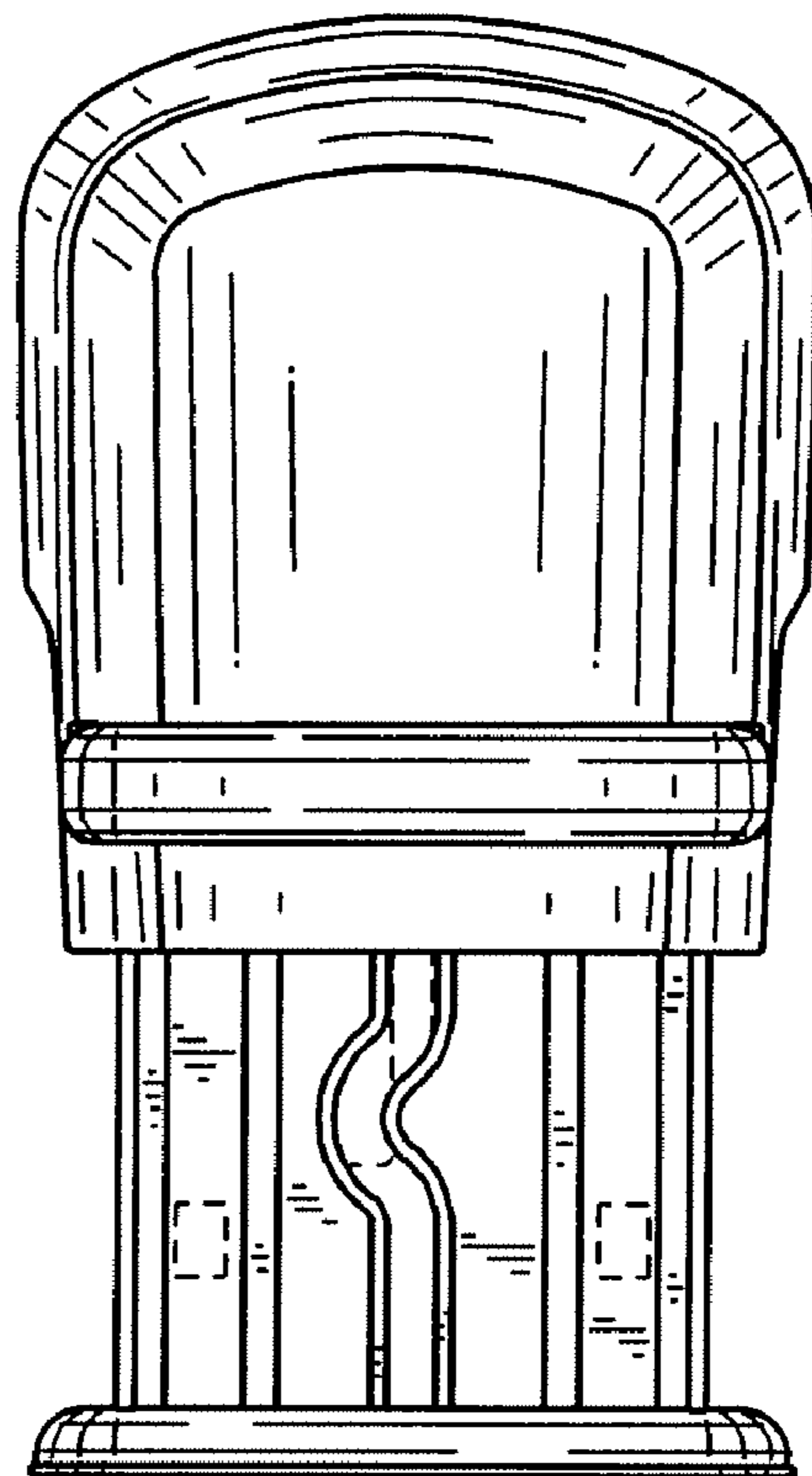

FIG. 11

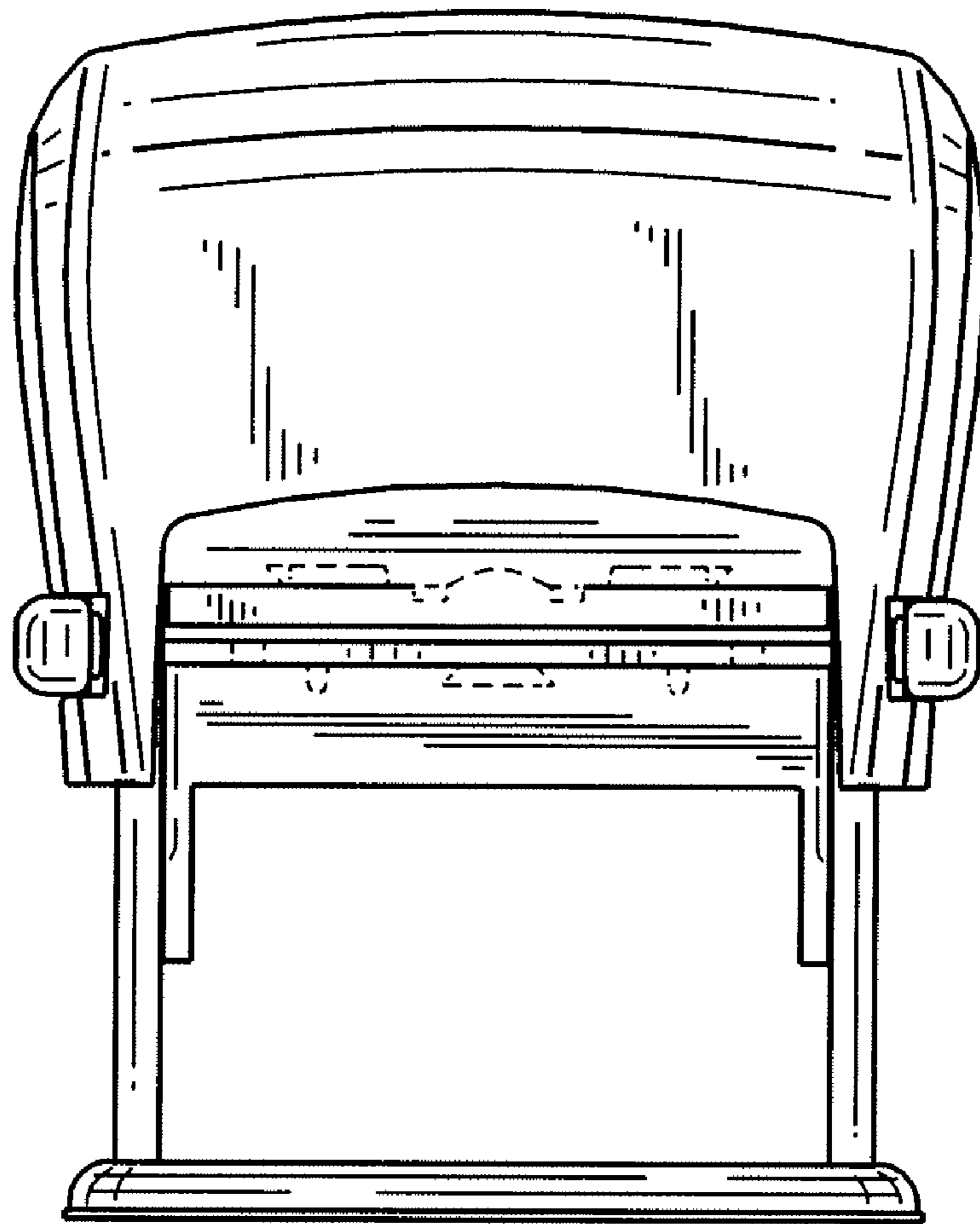

FIG. 12



FIG. 13

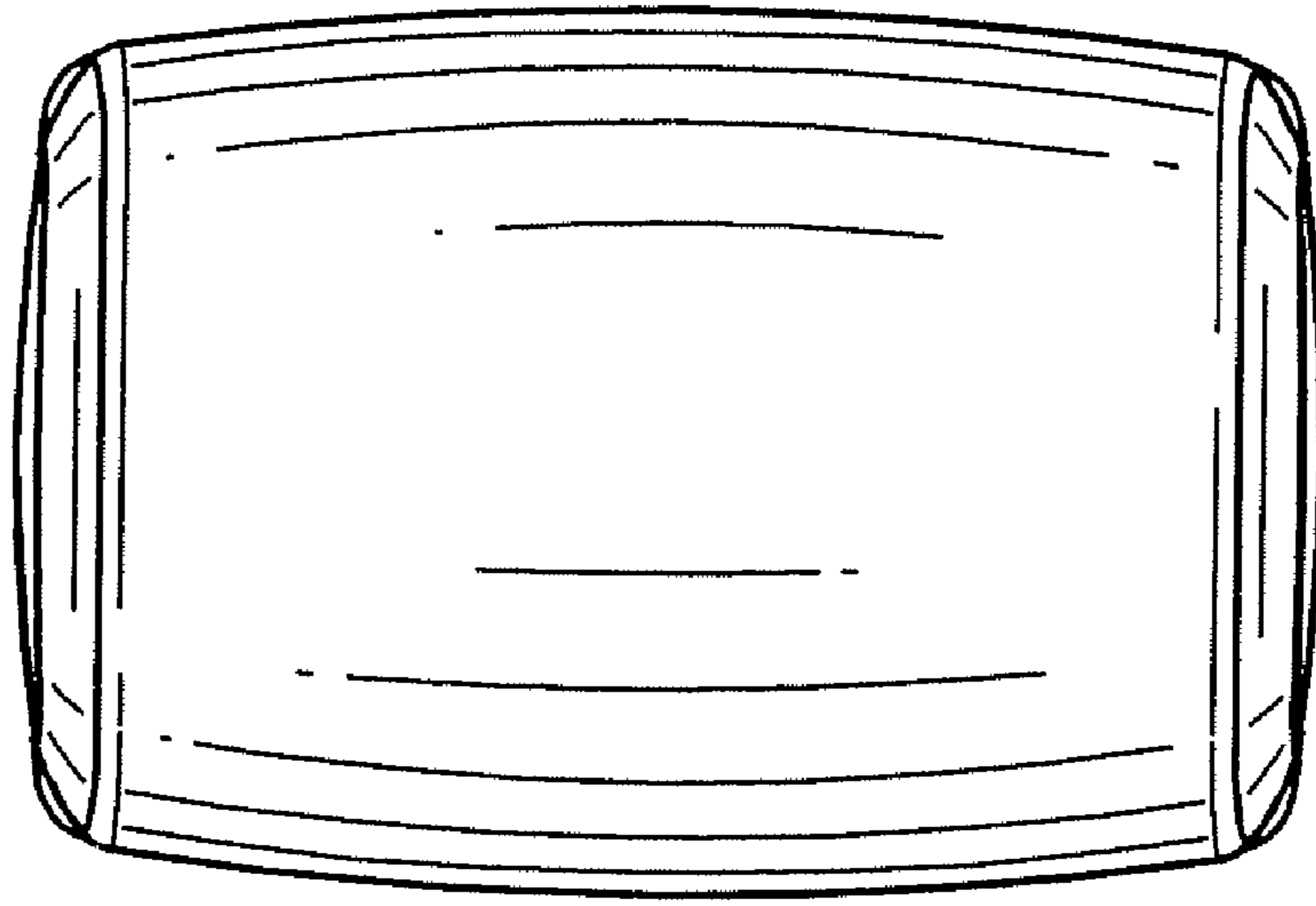

FIG. 14

