

US00D587708S

(12) **United States Design Patent**
Yoshida et al.

(10) **Patent No.:** **US D587,708 S**
(45) **Date of Patent:** **** Mar. 3, 2009**

(54) **WIRELESS RECEIVER**

D441,744 S * 5/2001 Miyazaki D14/137
D489,720 S * 5/2004 Sasaki D14/358

(75) Inventors: **Koshin Yoshida**, Machida (JP); **Daisuke Watanabe**, Machida (JP)

* cited by examiner

(73) Assignee: **Kabushiki Kaisha Audio-Technica**, Machida-Shi, Tokyo (JP)

Primary Examiner—Brian N Vinson
(74) *Attorney, Agent, or Firm*—Manabu Kanesaka

(**) Term: **14 Years**

(57) **CLAIM**

(21) Appl. No.: **29/290,816**

The ornamental design for a wireless receiver, as shown and described.

(22) Filed: **Jan. 17, 2008**

DESCRIPTION

(30) **Foreign Application Priority Data**

Jul. 18, 2007 (JP) 2007-019449

FIG. 1 is a top perspective view of a wireless receiver showing my new design;

(51) **LOC (9) Cl.** **14-02**

FIG. 2 is a bottom perspective view thereof;

(52) **U.S. Cl.** **D14/358**

FIG. 3 is a front view thereof;

(58) **Field of Classification Search** D14/356,
D14/358, 432, 433, 137, 138, 140, 155, 188,
D14/217, 240, 299, 191; D13/110, 184;
439/488, 490, 901; 379/1.03, 38, 39, 42,
379/67.1, 88.17, 90.01, 93.01, 93.17, 142.07,
379/219, 220.01, 221.14, 221.15, 387.01,
379/397, 399.01, 419, 428.01, 457; 455/3.01,
455/3.05, 3.06, 426.1, 500, 73, 74, 556.1,
455/561, 575.1, 89, 91, 95, 130, 132, 344,
455/347, 899, FOR. 254

FIG. 4 is a rear view thereof;

FIG. 5 is a top plan view thereof;

FIG. 6 is a bottom view thereof;

FIG. 7 is a left side view thereof;

FIG. 8 is a right side view thereof;

FIG. 9 is a top perspective view with antennas removed;

FIG. 10 is a bottom perspective view with antennas removed;

FIG. 11 is a front view with antennas removed;

FIG. 12 is a rear view with antennas removed;

FIG. 13 is a top plan view with antennas removed;

FIG. 14 is a bottom view with antennas removed;

FIG. 15 is a left side view with antennas removed; and,

FIG. 16 is a right side view with antennas removed.

See application file for complete search history.

The broken lines are included for the purpose of illustrating portions of the wireless receiver that form no part of the claimed design.

(56) **References Cited**

U.S. PATENT DOCUMENTS

D338,193 S * 8/1993 Sasaki D14/433
5,761,612 A * 6/1998 Read 455/91
D409,199 S * 5/1999 Taguchi et al. D14/217
D430,147 S * 8/2000 Willkens et al. D4/137
D433,642 S * 11/2000 Bauman D14/358
D439,243 S * 3/2001 Miyazaki D14/137
D441,743 S * 5/2001 Uehara D14/137

1 Claim, 5 Drawing Sheets

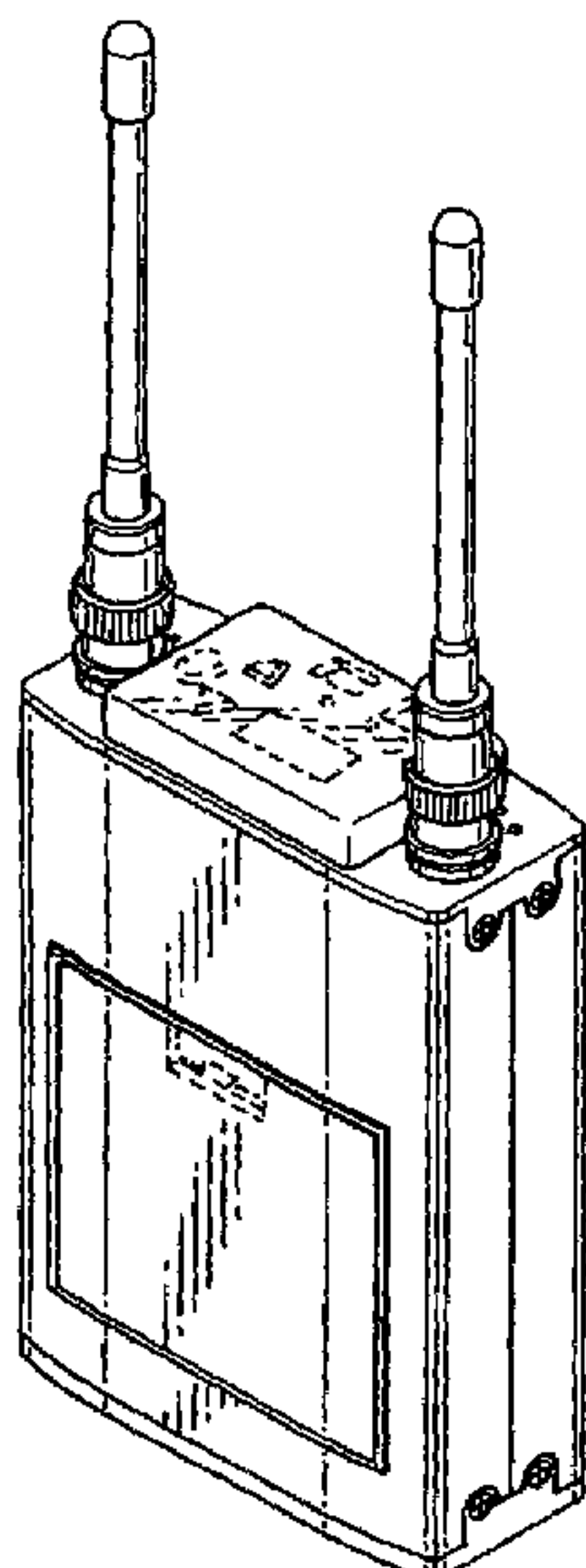

FIG. 1

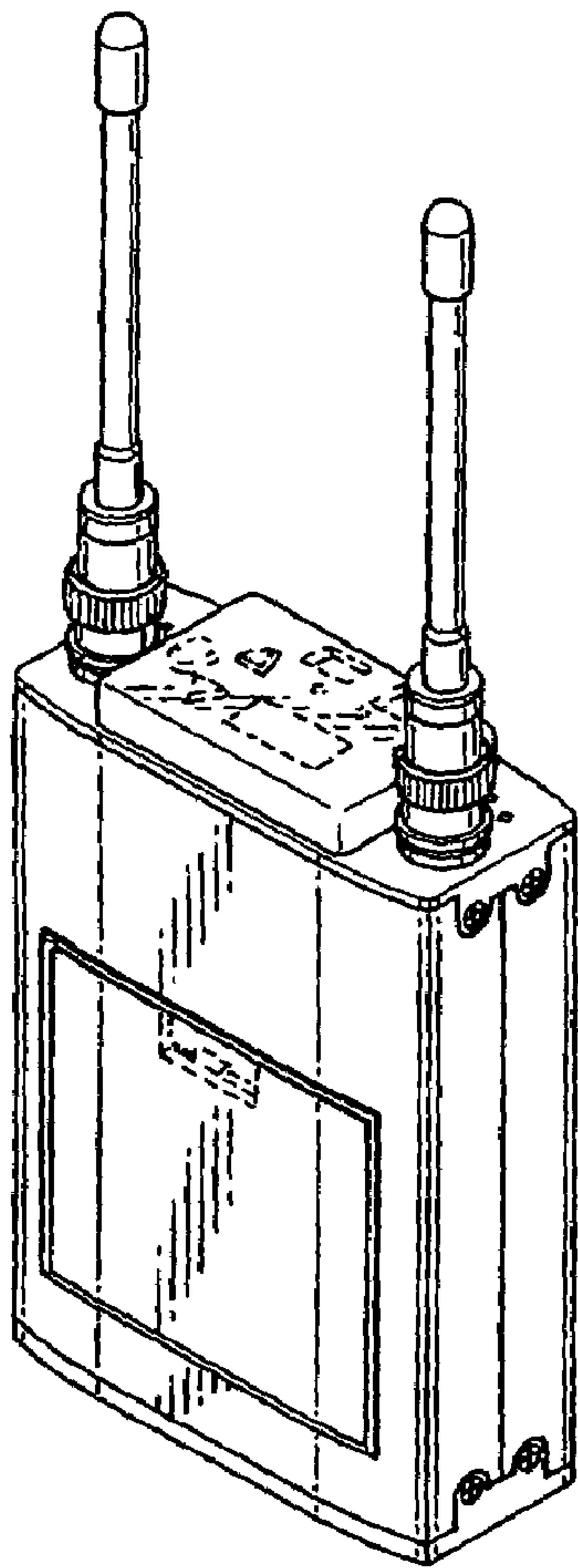

FIG. 2

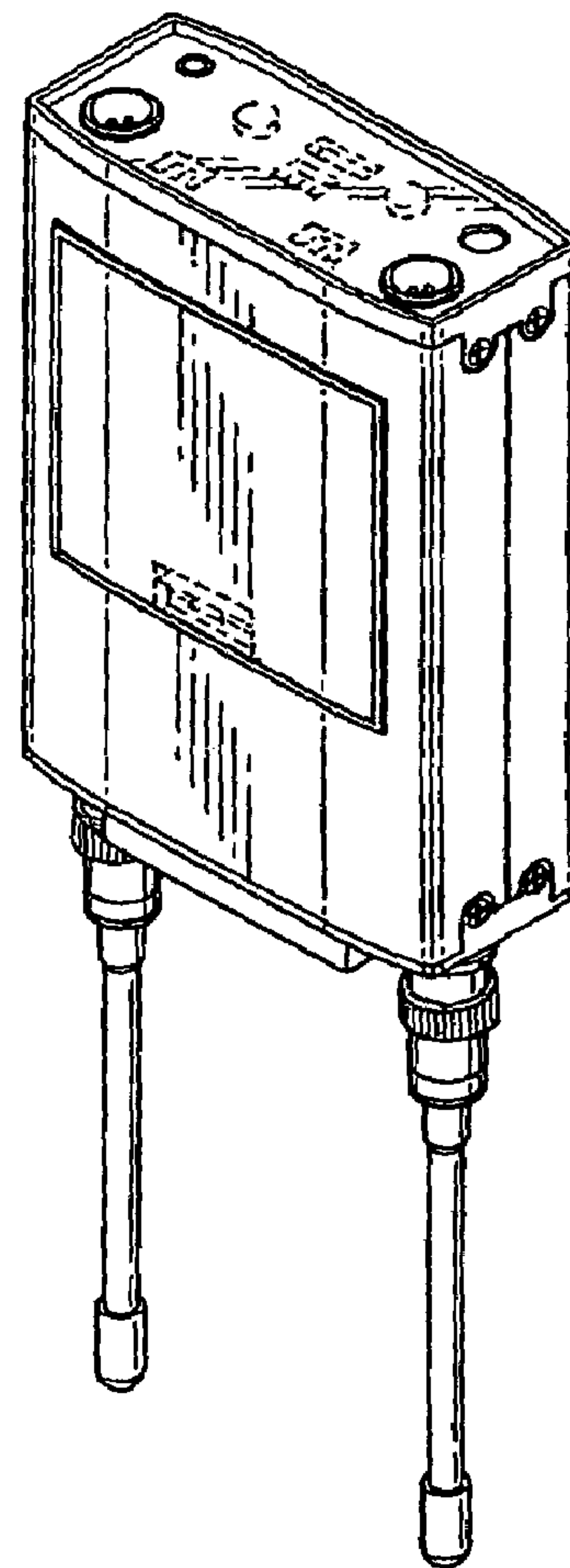

FIG. 3

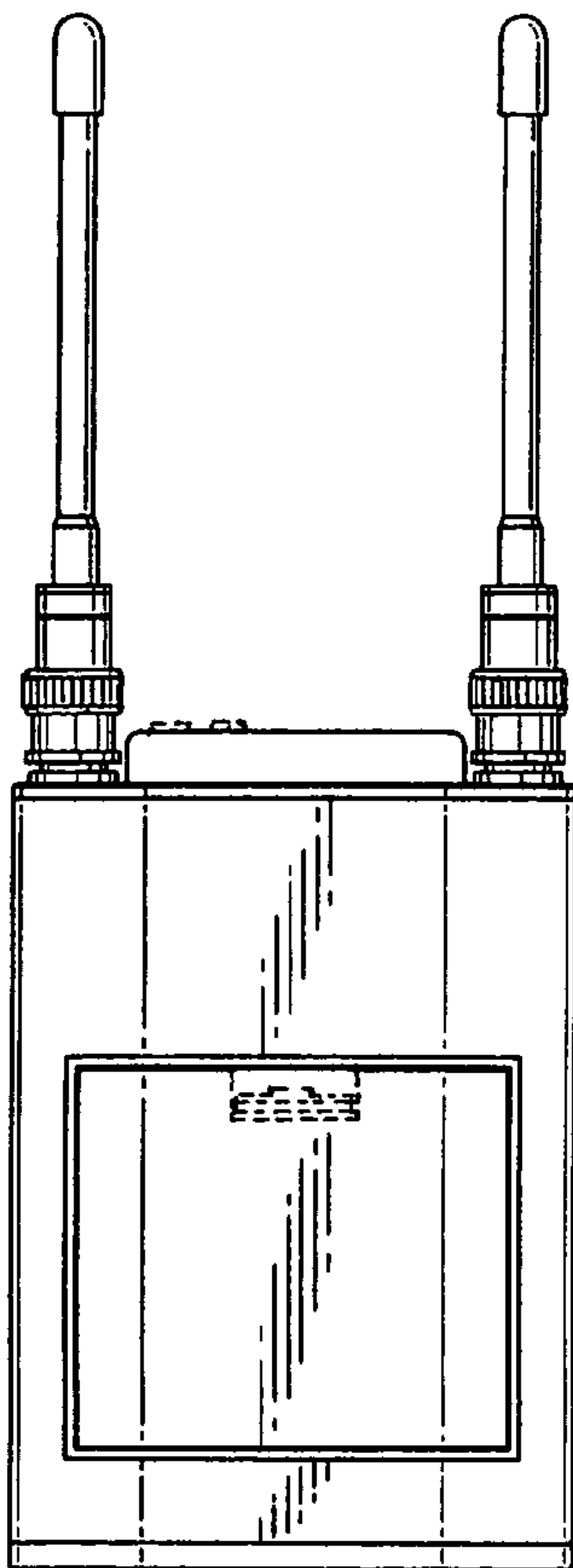

FIG. 4

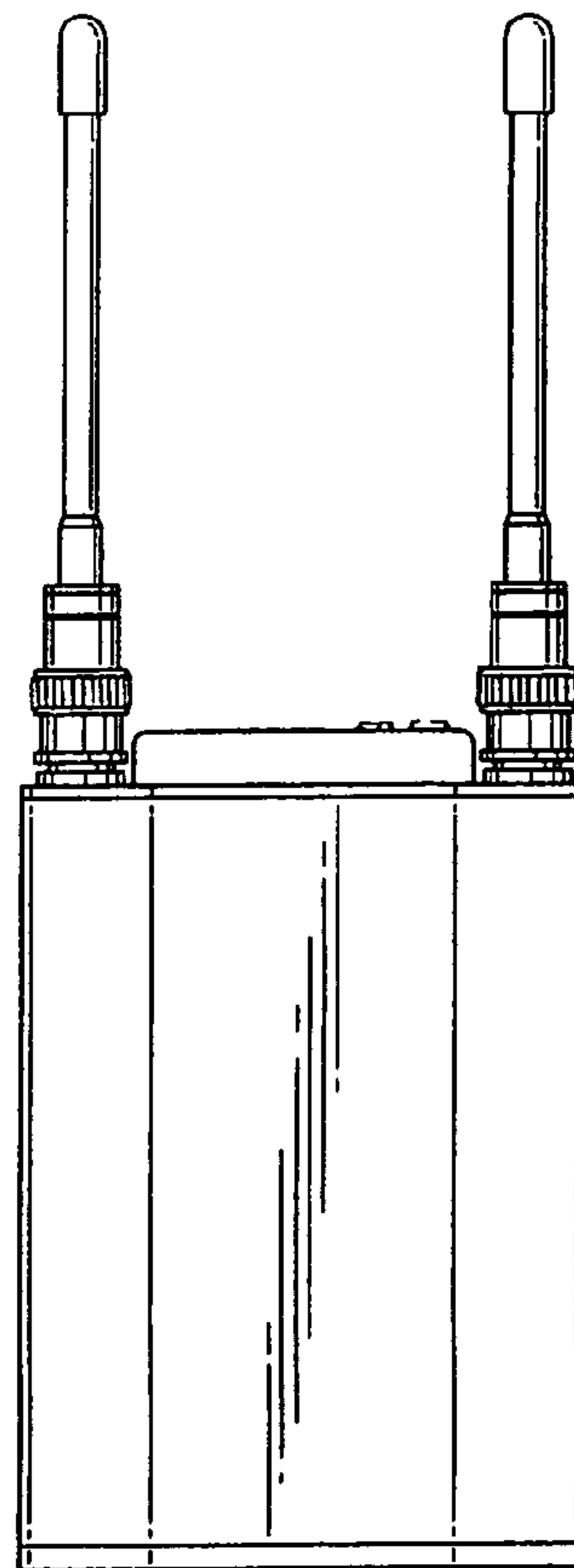

FIG. 5

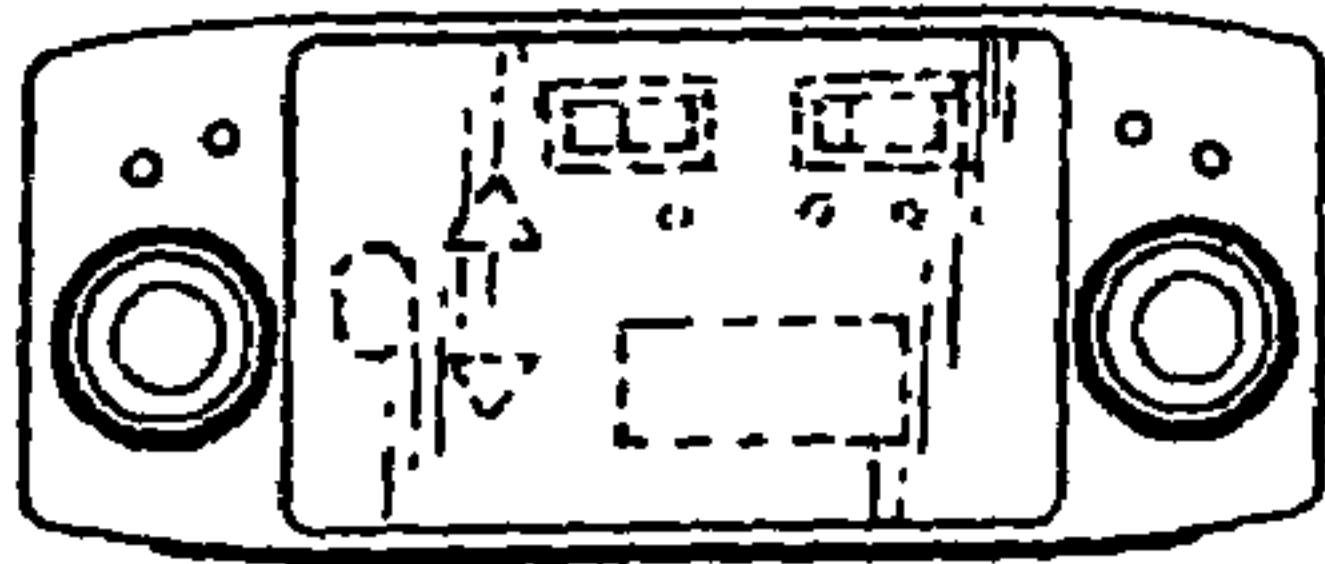

FIG. 6

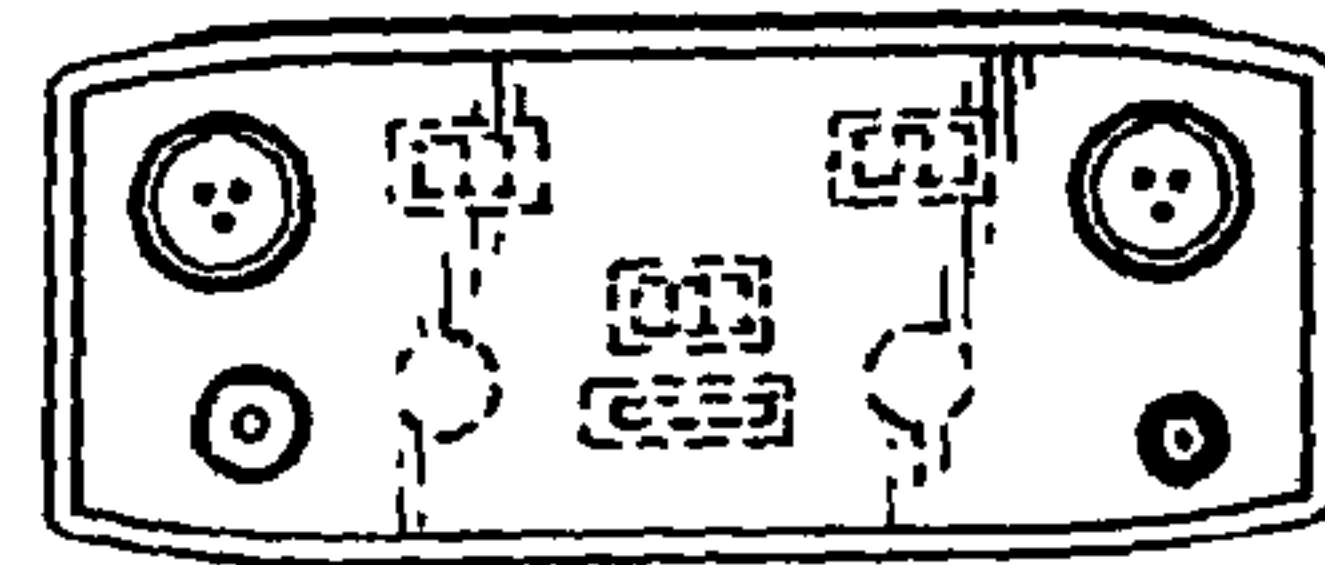

FIG. 7

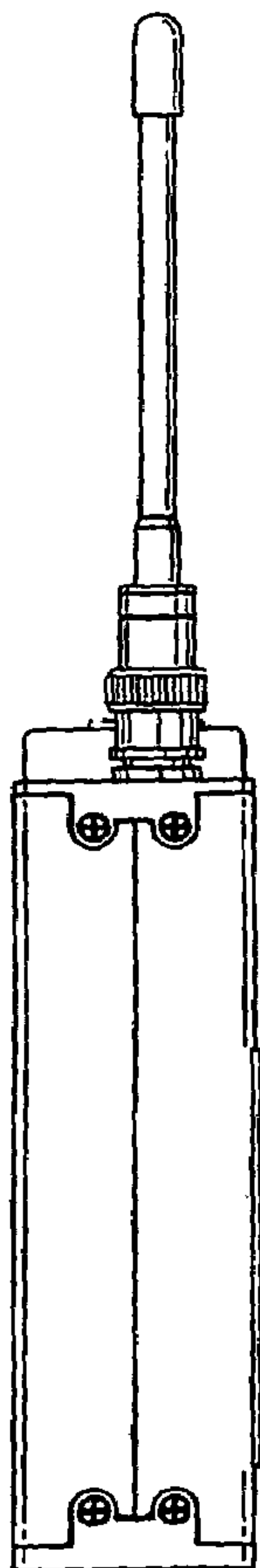

FIG. 8

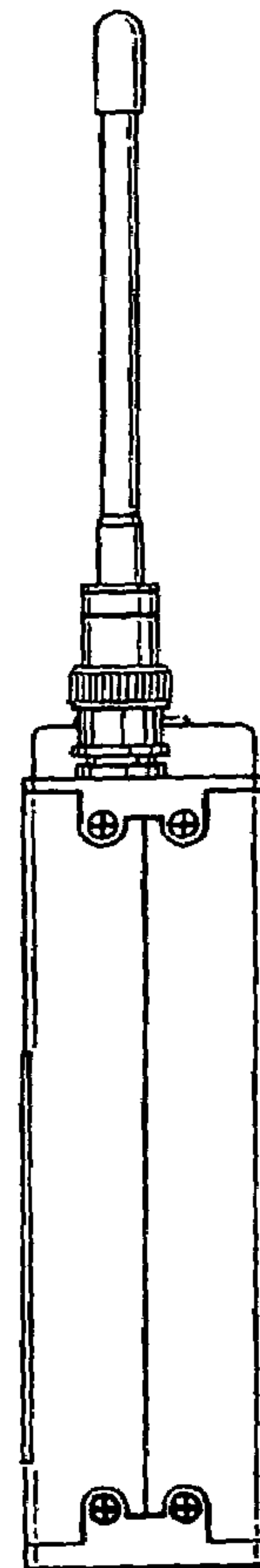

FIG. 9

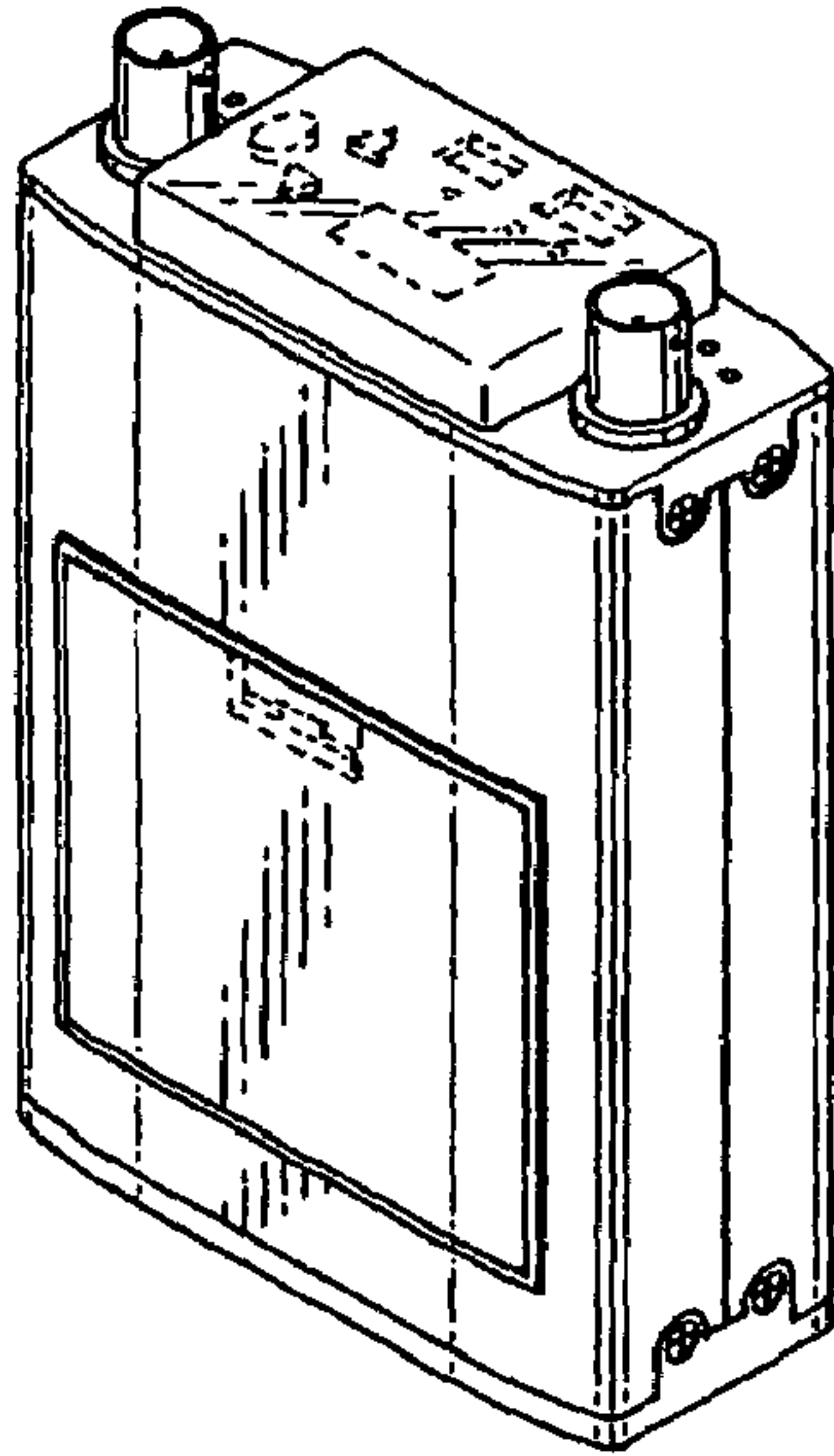

FIG. 10

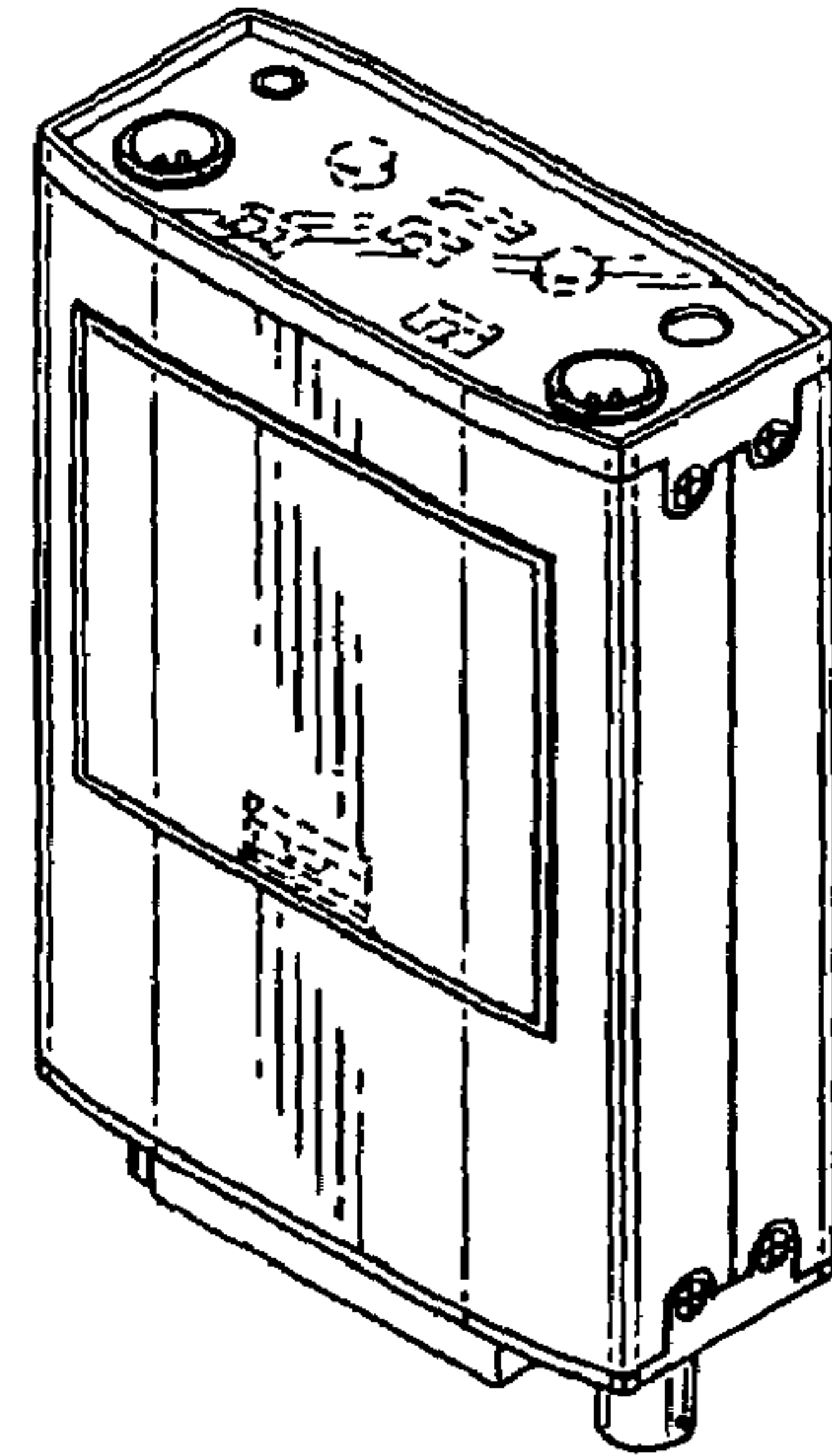

FIG. 11

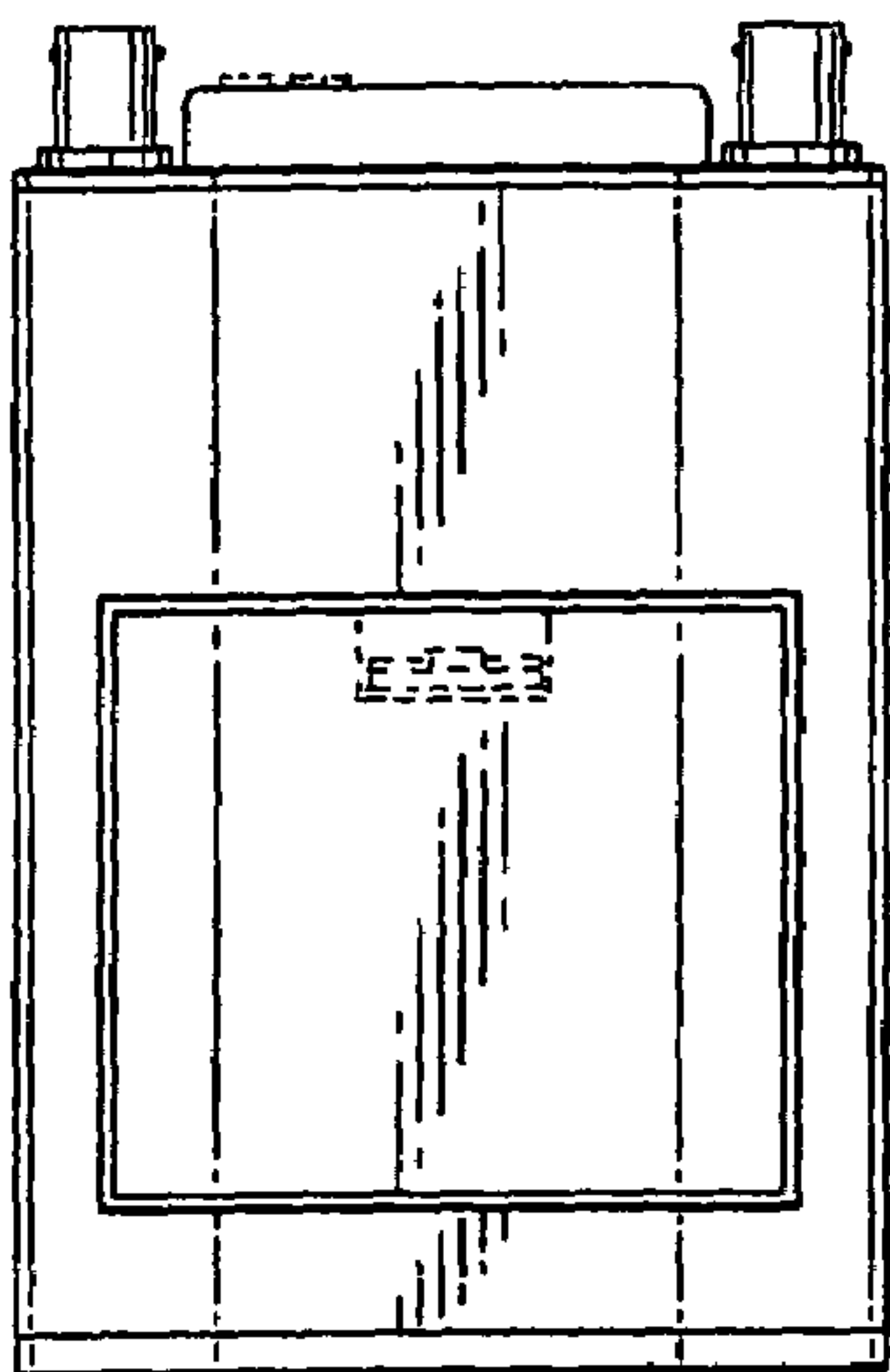

FIG. 12

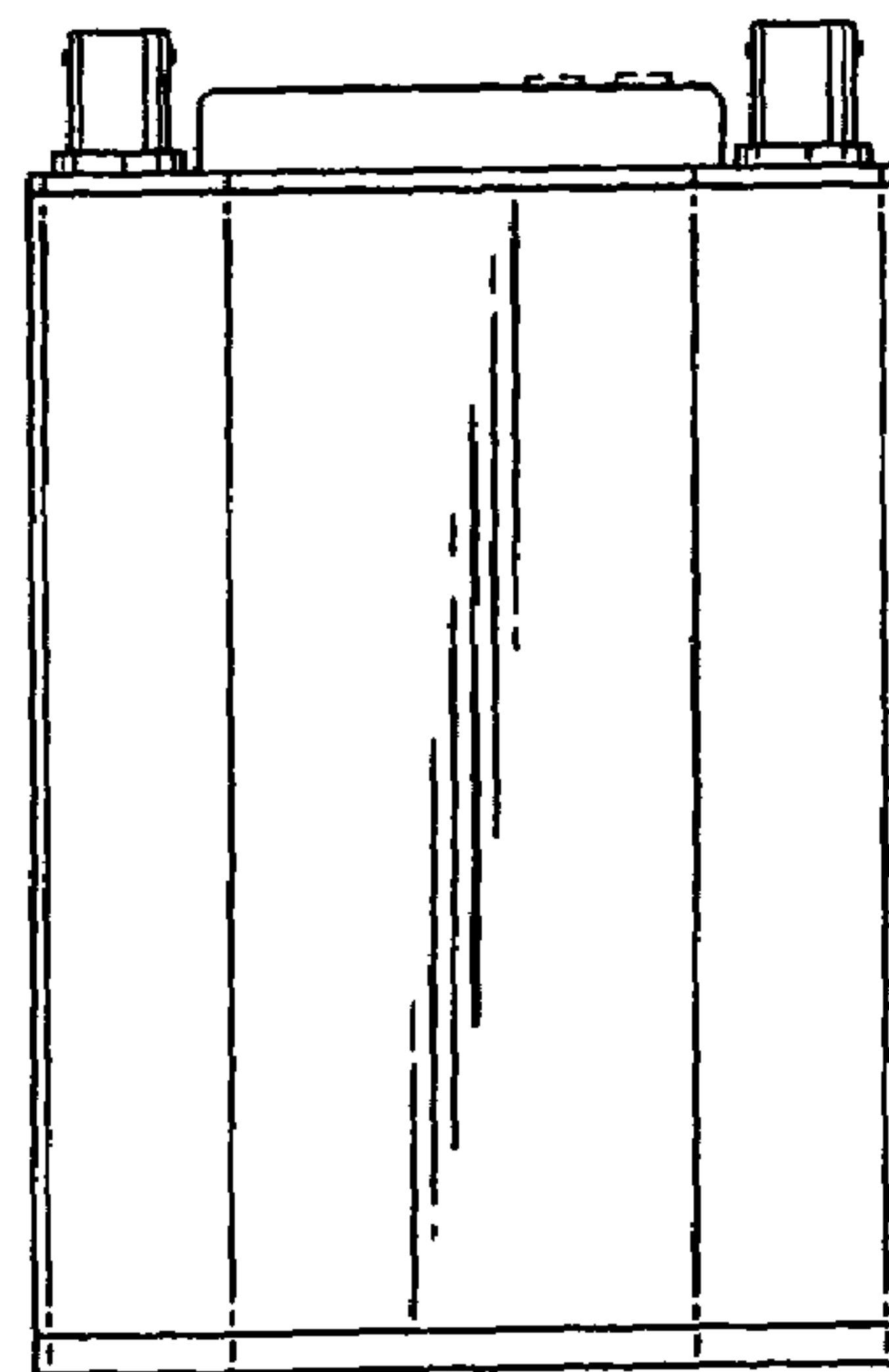

FIG. 13

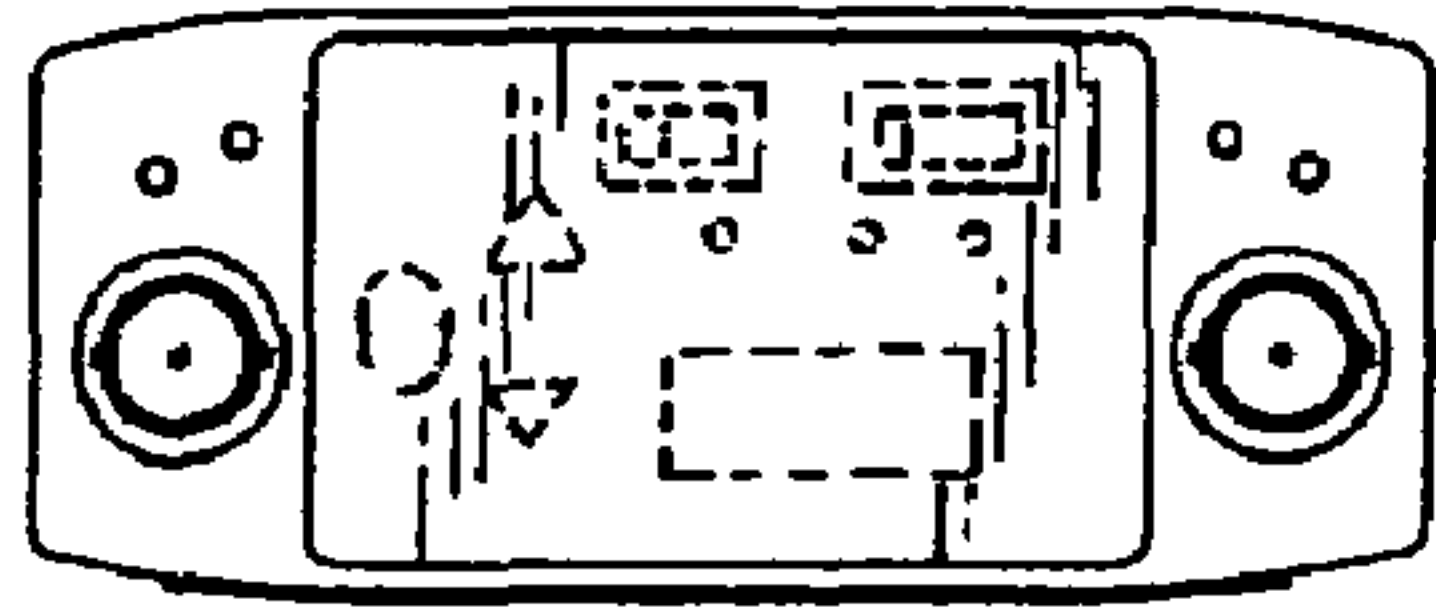

FIG. 14

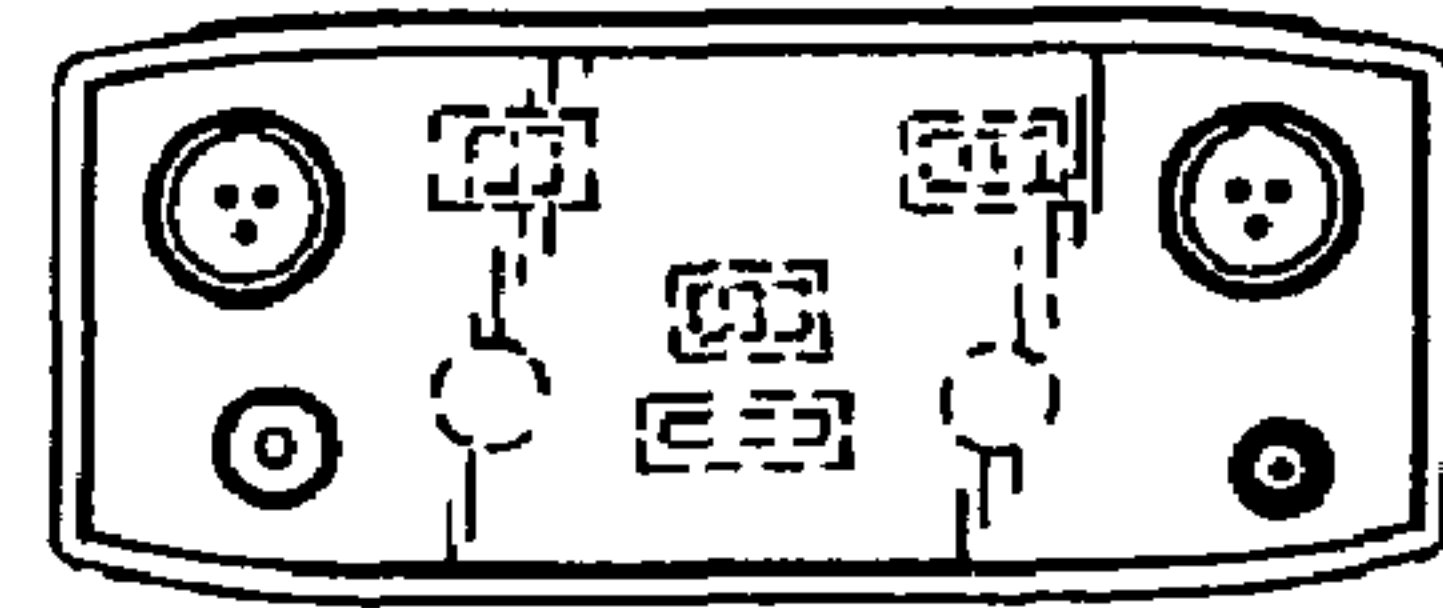

FIG. 15

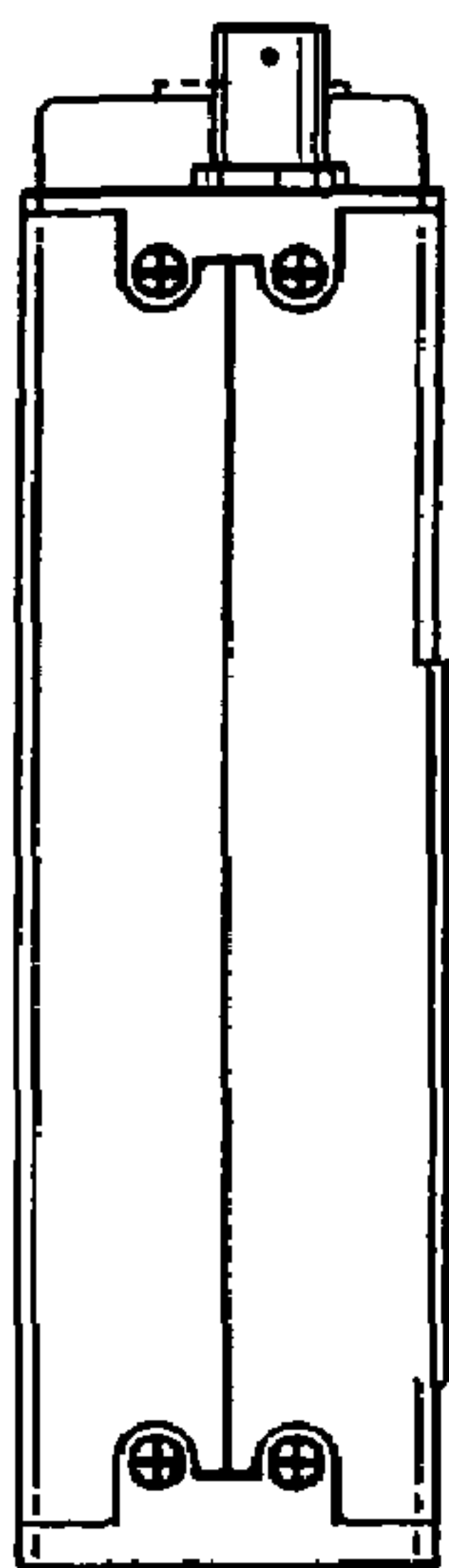

FIG. 16

