



US00D587670S

(12) **United States Design Patent**
Kim et al.

(10) **Patent No.:** **US D587,670 S**
(45) **Date of Patent:** **** Mar. 3, 2009**

(54) **MOBILE PHONE**

(75) Inventors: **Young-Sae Kim**, Palo Alto, CA (US);
Ji-Eun Lee, Seoul (KR); **Young-Ju Yeo**,
Seoul (KR); **Chang-Soo Lee**, Incheon
(KR)

(73) Assignee: **Samsung Electronics Co., Ltd.**,
Suwon-Si (KR)

(**) Term: **14 Years**

(21) Appl. No.: **29/300,438**

(22) Filed: **Mar. 26, 2008**

(30) **Foreign Application Priority Data**

Nov. 2, 2007 (KR) 30-2007-0045687

(51) **LOC (9) Cl.** **14-03**

(52) **U.S. Cl.** **D14/138 AD**

(58) **Field of Classification Search** D14/137,
D14/138 R, 138 AA, 138 AB, 138 AC, 138 AD,
D14/138 C, 138 G, 147, 191, 218, 247-248,
D14/341-347, 496; D10/65, 78, 104; D13/168;
D18/7; 455/556.1, 566, 575.1, 575.3; 345/169
See application file for complete search history.

(56) **References Cited**

U.S. PATENT DOCUMENTS

- D386,152 S * 11/1997 Warneke D14/347
- D495,695 S * 9/2004 Yugaya D14/346
- D496,645 S * 9/2004 Yoo et al. D14/138 G
- D498,736 S * 11/2004 Lee D14/138 AB
- D525,609 S * 7/2006 Kim et al. D14/138 AB
- D529,465 S * 10/2006 Kim et al. D14/138 AD
- D531,608 S * 11/2006 Kim et al. D14/138 AD
- D531,611 S * 11/2006 Kim et al. D14/138 AD
- D534,145 S * 12/2006 Lheem D14/138 AD
- D534,890 S * 1/2007 Kim D14/138 AD
- D537,075 S * 2/2007 Helin D14/247
- D540,765 S * 4/2007 Pritchard et al. D14/137
- D543,966 S * 6/2007 Peng et al. D14/138 AD
- D545,290 S * 6/2007 Yau D14/138 AD

- D551,201 S * 9/2007 Kim et al. D14/138 AD
- D555,169 S * 11/2007 Shimizu et al. D14/496
- D558,726 S * 1/2008 Wang et al. D14/138 AD
- D561,148 S * 2/2008 Chen D14/138 AD

(Continued)

OTHER PUBLICATIONS

Gigabyte g-Smart i300, announced 2nd quarter 2006, [online],
[retrieved on Feb. 20, 2007]. Retrieved from Internet ,<URL: http://
www.gsmarena.com>.*

LG V9000, announced Feb. 2006, [online], [retrieved on Feb. 20,
2007]. Retrieved from Internet ,<URL: http://www.gsmarena.
com>.*

Sharp TM100, announced 1st quarter 2004, [online], [retrieved on
Feb. 20, 2007]. Retrieved from Internet ,<URL: http://www.
gsmarena.com>.*

Sony Ericsson S500, announced May 2007, [online], [retrieved on
May 18, 2007]. Retrieved from Internet ,<URL: http://www.
gsmarena.com>.*

Primary Examiner—Jeffrey D Asch

Assistant Examiner—Bridget L Eland

(74) *Attorney, Agent, or Firm*—Staas & Halsey LLP

(57) **CLAIM**

The ornamental design for a mobile phone, as shown and
described.

DESCRIPTION

FIG. 1 is a perspective view of a mobile phone;
 FIG. 2 is a front view of the mobile phone of FIG. 1;
 FIG. 3 is a rear view of the mobile phone of FIG. 1;
 FIG. 4 is a left-side view of the mobile phone of FIG. 1;
 FIG. 5 is a right-side view of the mobile phone of FIG. 1;
 FIG. 6 is a top plan view of the mobile phone of FIG. 1;
 FIG. 7 is a bottom plan view of the mobile phone of FIG. 1;
 FIG. 8 is an open perspective view of the mobile phone of
 FIG. 1; and,
 FIG. 9 is an open rear view of the mobile phone of FIG. 1.

1 Claim, 7 Drawing Sheets

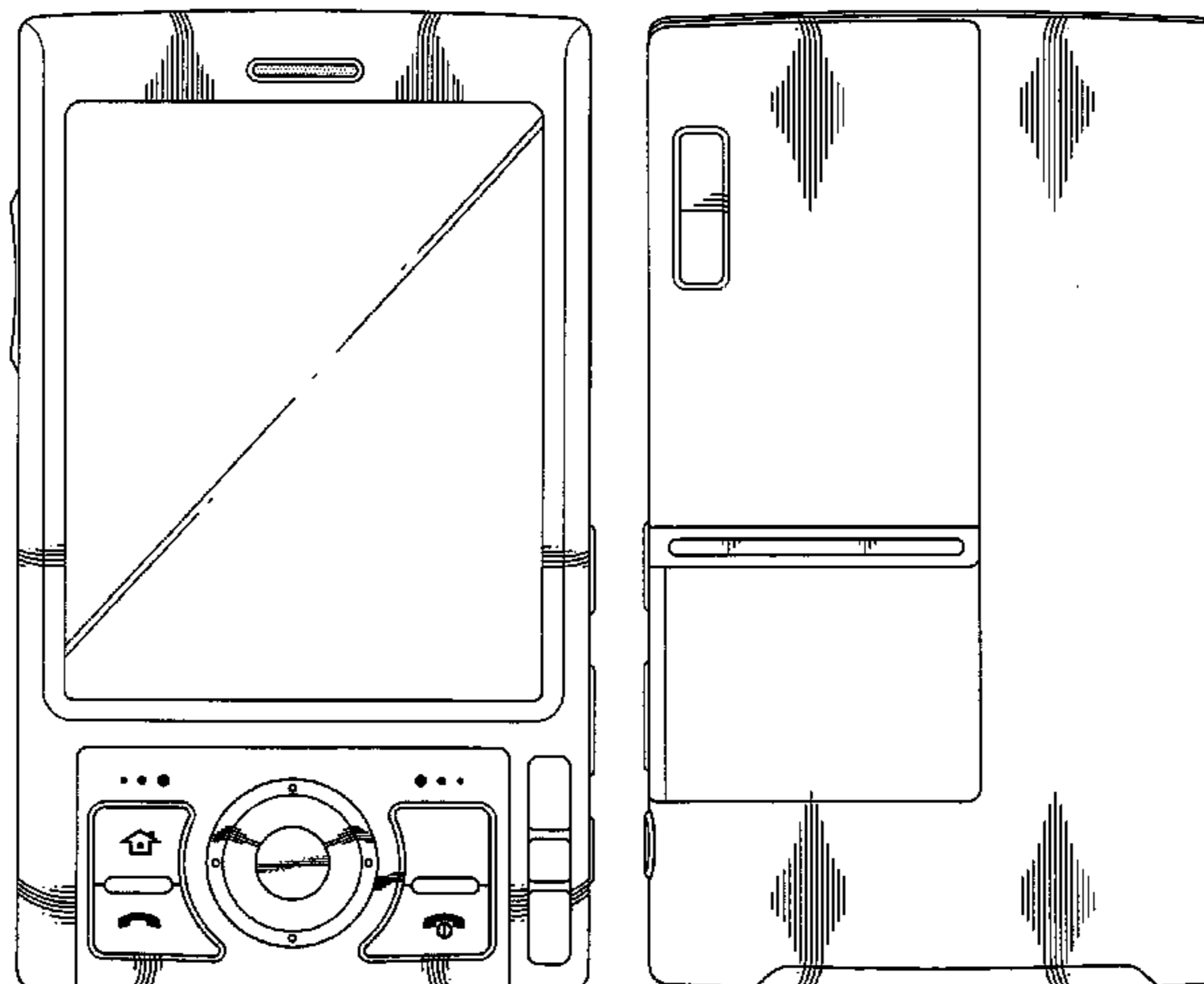

US D587,670 S

Page 2

U.S. PATENT DOCUMENTS			
		2006/0170656 A1*	8/2006 Kwon 345/169
7,345,833 B2*	3/2008 Hwang	2007/0082718 A1*	4/2007 Yoon et al. 455/575.4
D565,532 S *	4/2008 Arnold	2008/0004085 A1*	1/2008 Jung et al. 455/566
D567,795 S *	4/2008 Cha et al.	2008/0051041 A1*	2/2008 Griffin et al. 455/90.3
D576,141 S *	9/2008 Moon et al.		

* cited by examiner

FIG. 1

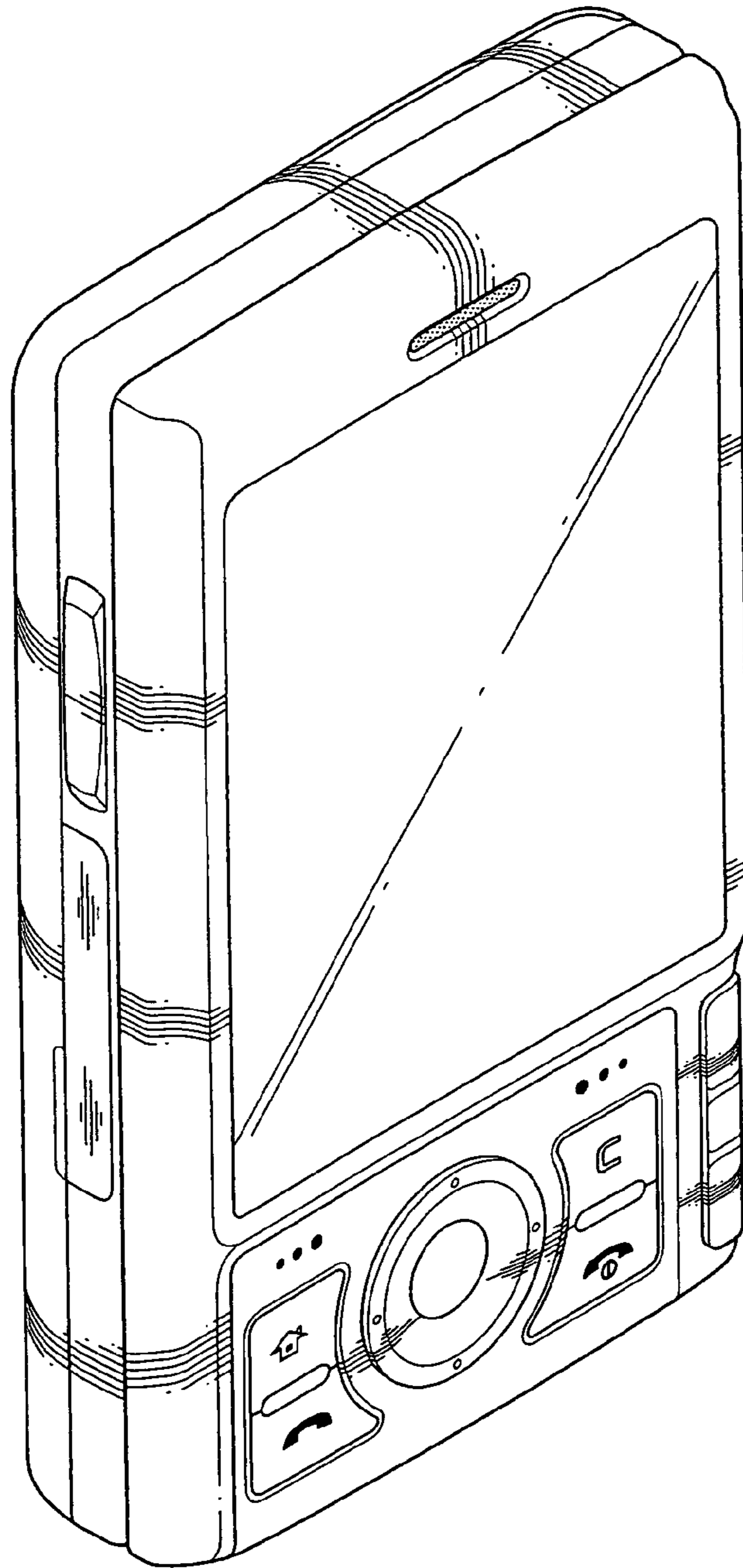

FIG.2

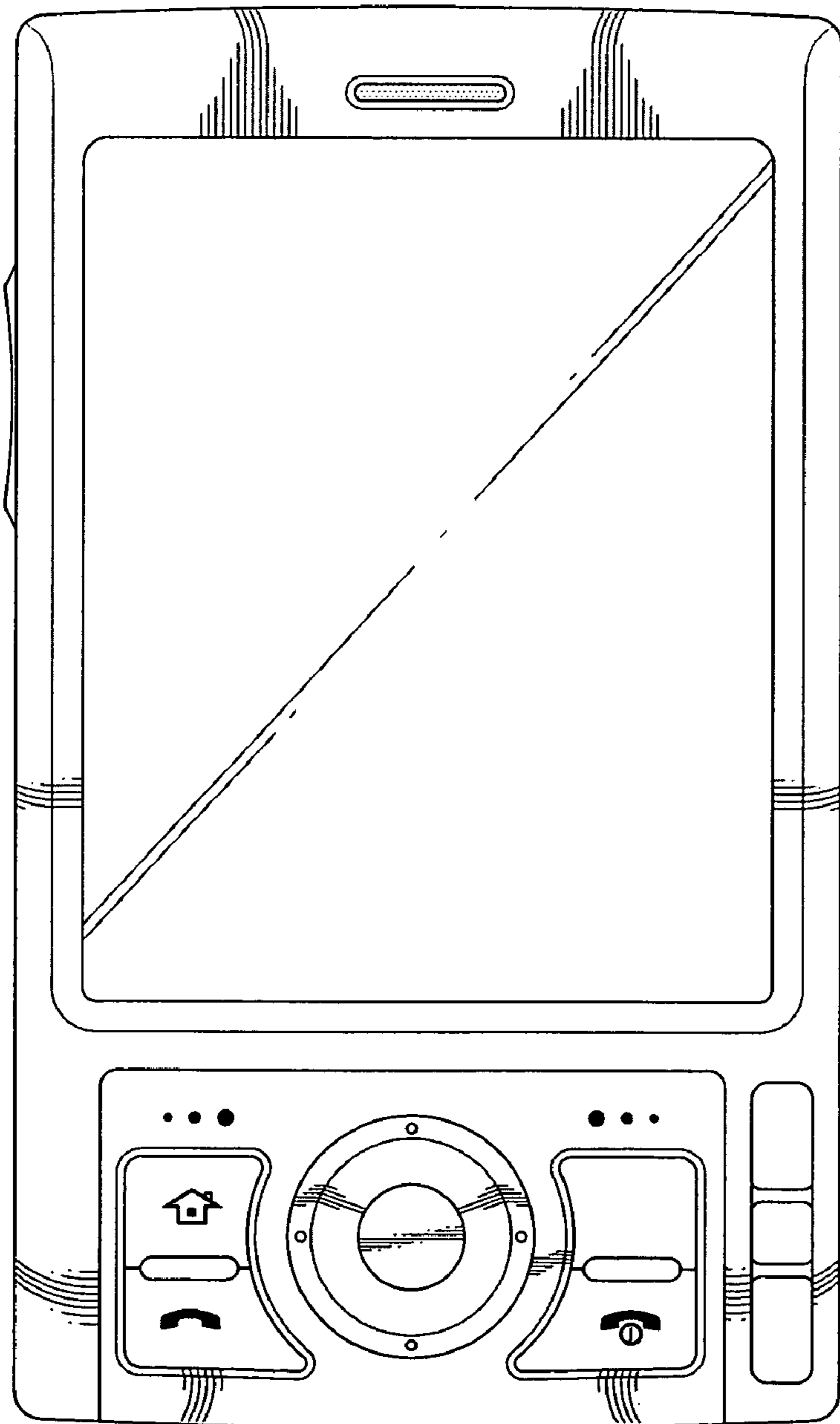

FIG.3

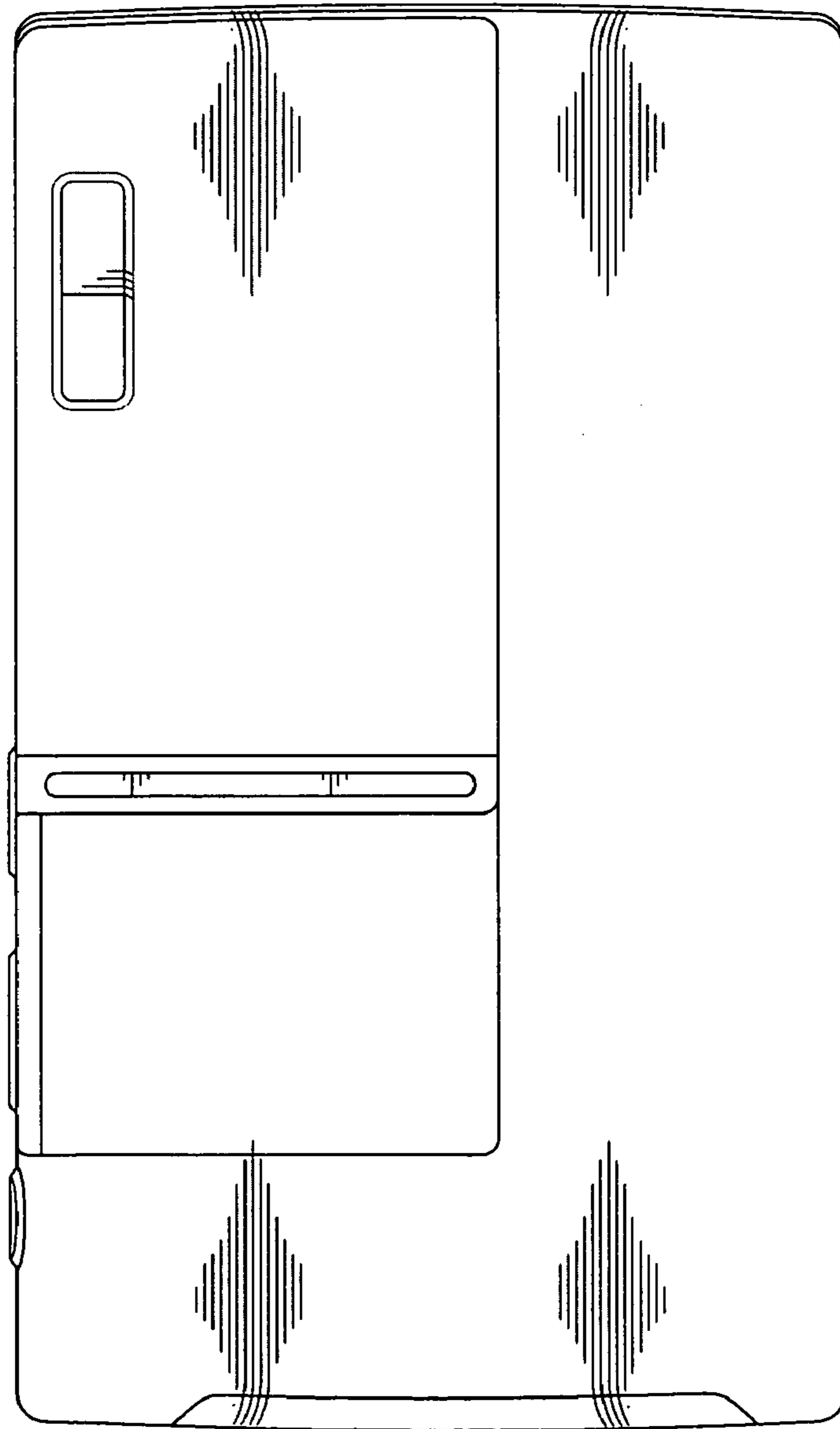

FIG.4

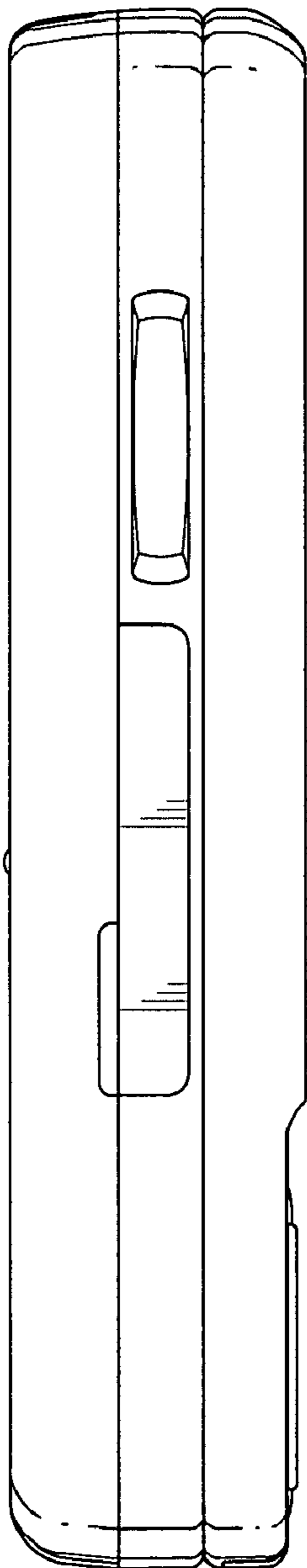

FIG.5

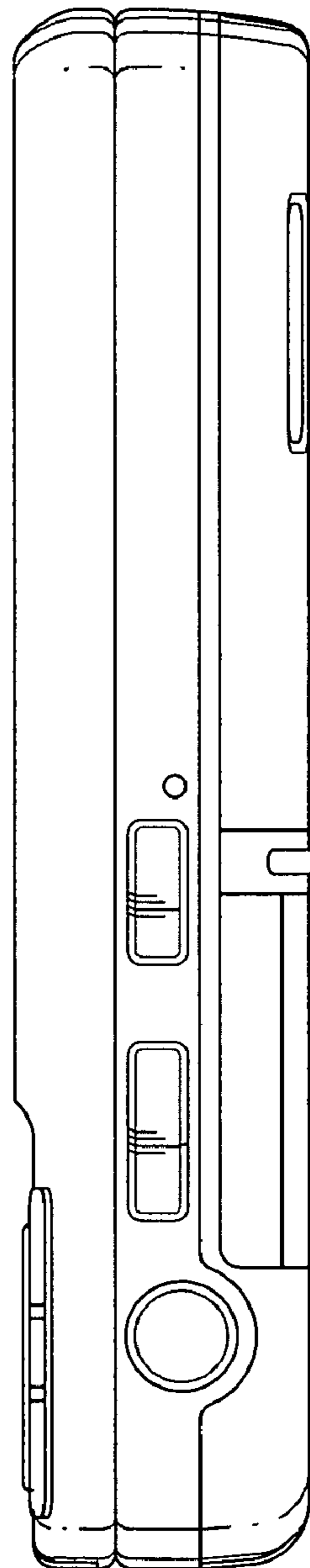

FIG. 6

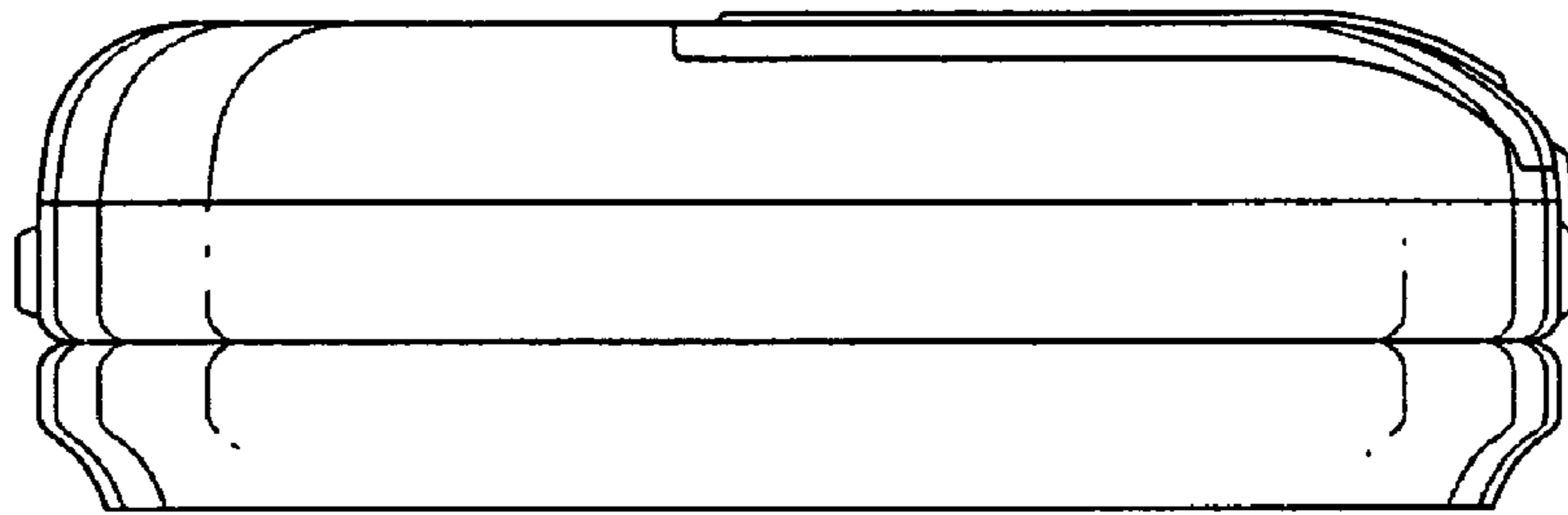

FIG. 7

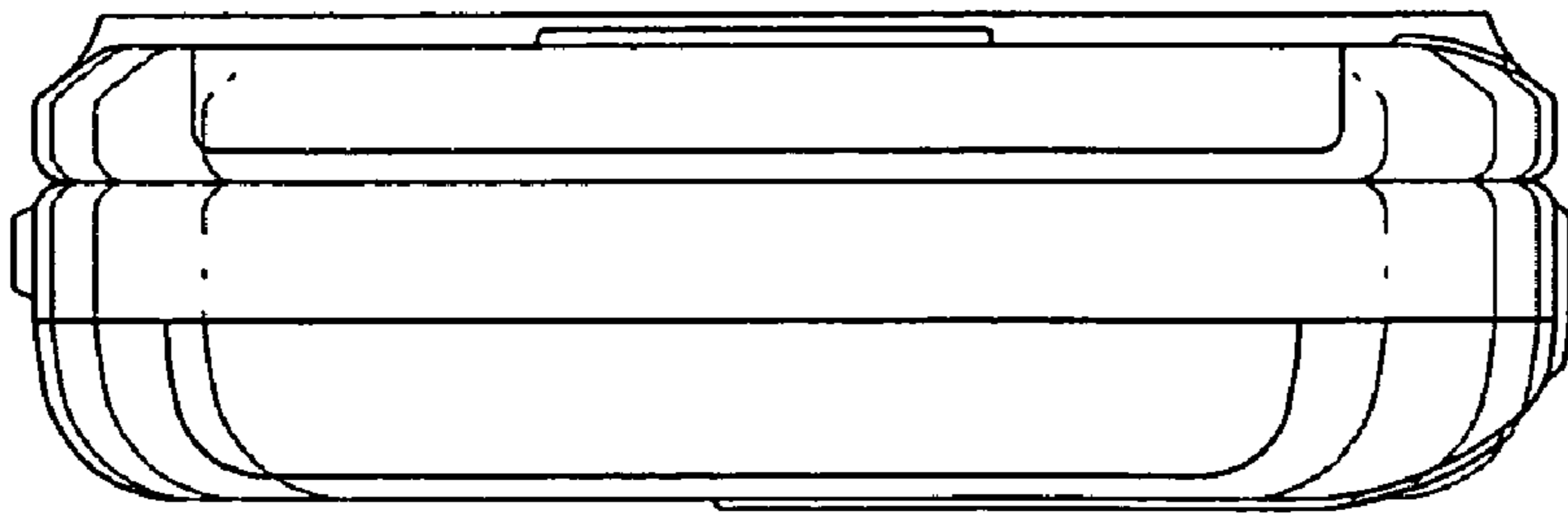

FIG. 8

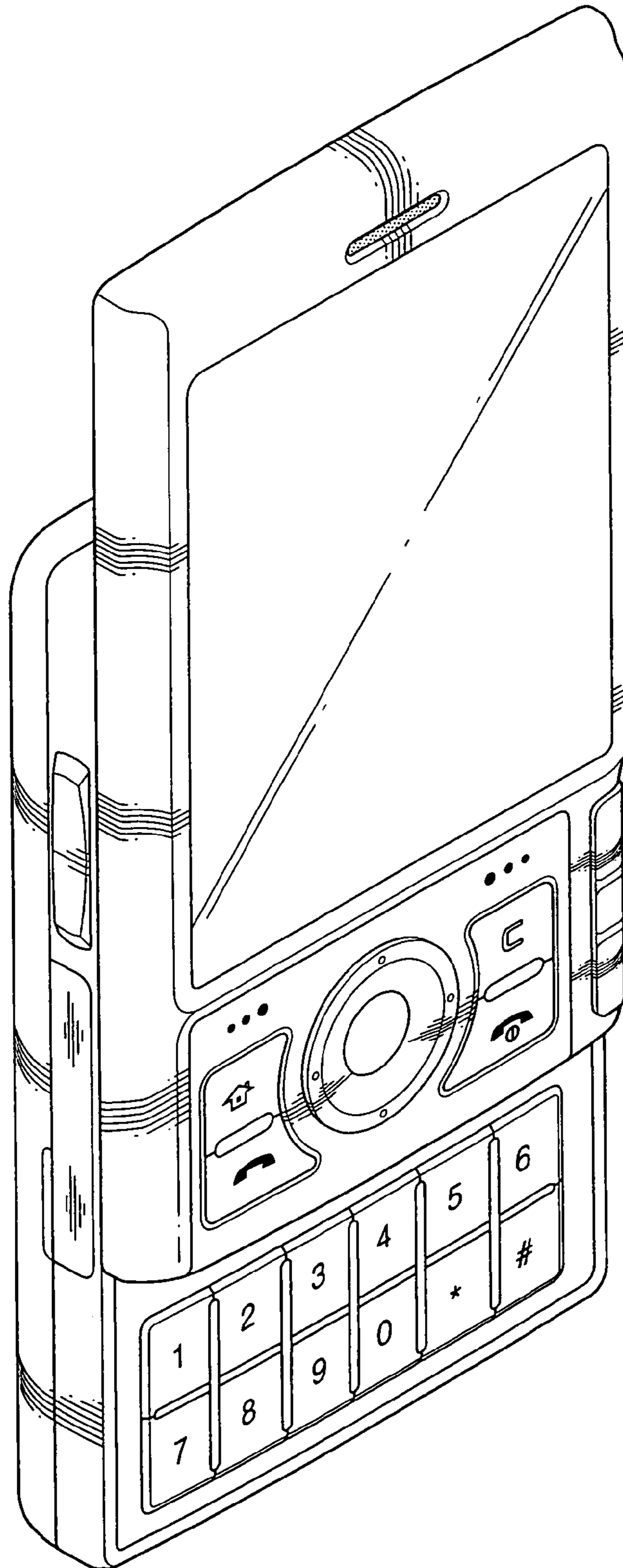

FIG.9

