



US00D587668S

(12) **United States Design Patent**
Bang et al.

(10) **Patent No.:** **US D587,668 S**
(45) **Date of Patent:** **** *Mar. 3, 2009**

(54) **MOBILE PHONE**

(75) Inventors: **Yong-Seok Bang**, Seoul (KR);
Sang-Min Hyun, Seoul (KR);
Chang-Hwan Hwang, Goyang-si (KR)

(73) Assignee: **Samsung Electronics Co., Ltd.**,
Suwon-Si (KR)

(*) Notice: This patent is subject to a terminal disclaimer.

(**) Term: **14 Years**

(21) Appl. No.: **29/290,094**

(22) Filed: **Oct. 19, 2007**

(30) **Foreign Application Priority Data**

Aug. 10, 2007 (KR) 30-2007-0034382

(51) **LOC (9) Cl.** **14-03**

(52) **U.S. Cl.** **D14/138 AD; D14/138 G**

(58) **Field of Classification Search** D14/137,
D14/138, 147, 191, 218, 247-248, 341-347,
D14/496; D10/65, 75, 104; D13/168; D18/7;
455/556.1, 566, 575.1, 575.3; 345/169

See application file for complete search history.

(56) **References Cited**

U.S. PATENT DOCUMENTS

- D506,937 S * 7/2005 Lee et al. D10/65
- 7,016,182 B2 * 3/2006 Brandenburg et al. 361/683
- D532,791 S * 11/2006 Kim D14/496
- D540,203 S * 4/2007 Jeon D10/65
- D541,785 S * 5/2007 Hwang et al. D14/138
- D542,768 S * 5/2007 Hwang et al. D14/138
- D542,769 S * 5/2007 Hwang et al. D14/138
- D543,876 S * 6/2007 Kalis et al. D10/65
- D548,713 S * 8/2007 Lee et al. D14/138
- D554,098 S * 10/2007 Lee D14/138
- D554,099 S * 10/2007 Kim et al. D14/138
- D555,134 S * 11/2007 Sung et al. D14/138

- D556,211 S * 11/2007 Howard et al. D14/496
- D557,239 S * 12/2007 Lee D14/138
- D557,674 S * 12/2007 Lee et al. D14/138
- D558,460 S * 1/2008 Yu et al. D6/308
- D558,720 S * 1/2008 Lee et al. D14/138

(Continued)

OTHER PUBLICATIONS

LG KE850 Prada, announced Jan. 2007, [online], [retrieved on Feb. 20, 2007]. Retrieved from Internet ,<URL: <http://www.gsmarena.com>>.*

Apple iPhone, announced Jan. 2007, [online], [retrieved on Mar. 12, 2007]. Retrieved from Internet ,<URL: <http://www.gsmarena.com>>.*

Samsung F520, announced Feb. 2007, [online], [retrieved on Feb. 16, 2007]. Retrieved from Internet ,<URL: <http://www.gsmarena.com>>.*

(Continued)

Primary Examiner—Jeffrey D Asch

Assistant Examiner—Bridget L Eland

(74) *Attorney, Agent, or Firm*—Staas & Halsey LLP

(57) **CLAIM**

The ornamental design for a mobile phone, as shown and described.

DESCRIPTION

FIG. 1 is a perspective view of a mobile phone;
 FIG. 2 is a front view of the mobile phone of FIG. 1;
 FIG. 3 is a rear view of the mobile phone of FIG. 1;
 FIG. 4 is left-side of the mobile phone of FIG. 1;
 FIG. 5 is right-side of the mobile phone of FIG. 1;
 FIG. 6 is top plan view of the mobile phone of FIG. 1;
 FIG. 7 is bottom plan view of the mobile phone of FIG. 1; and,
 FIG. 8 is an open perspective view of the mobile phone of FIG. 1.

1 Claim, 6 Drawing Sheets

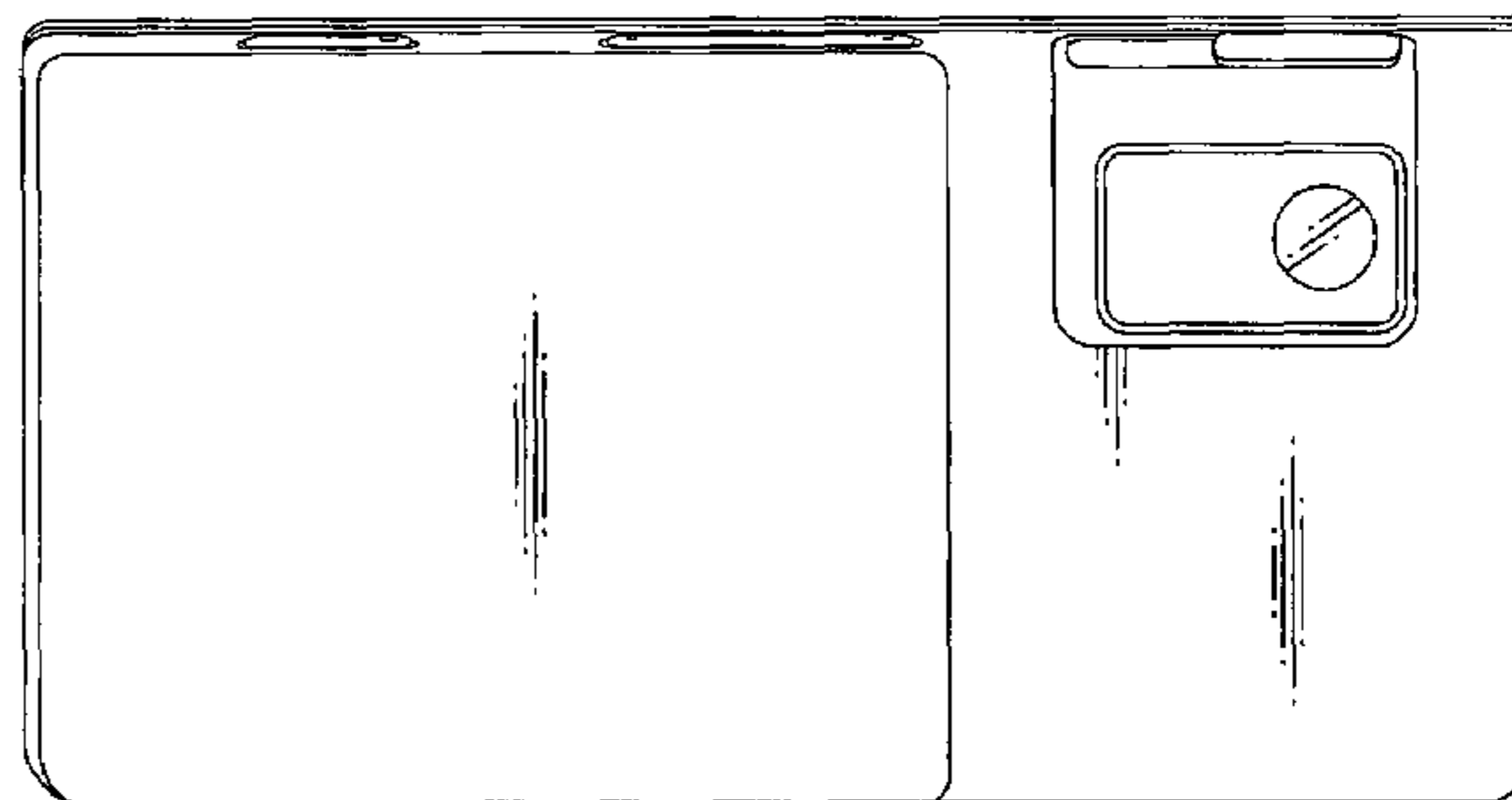
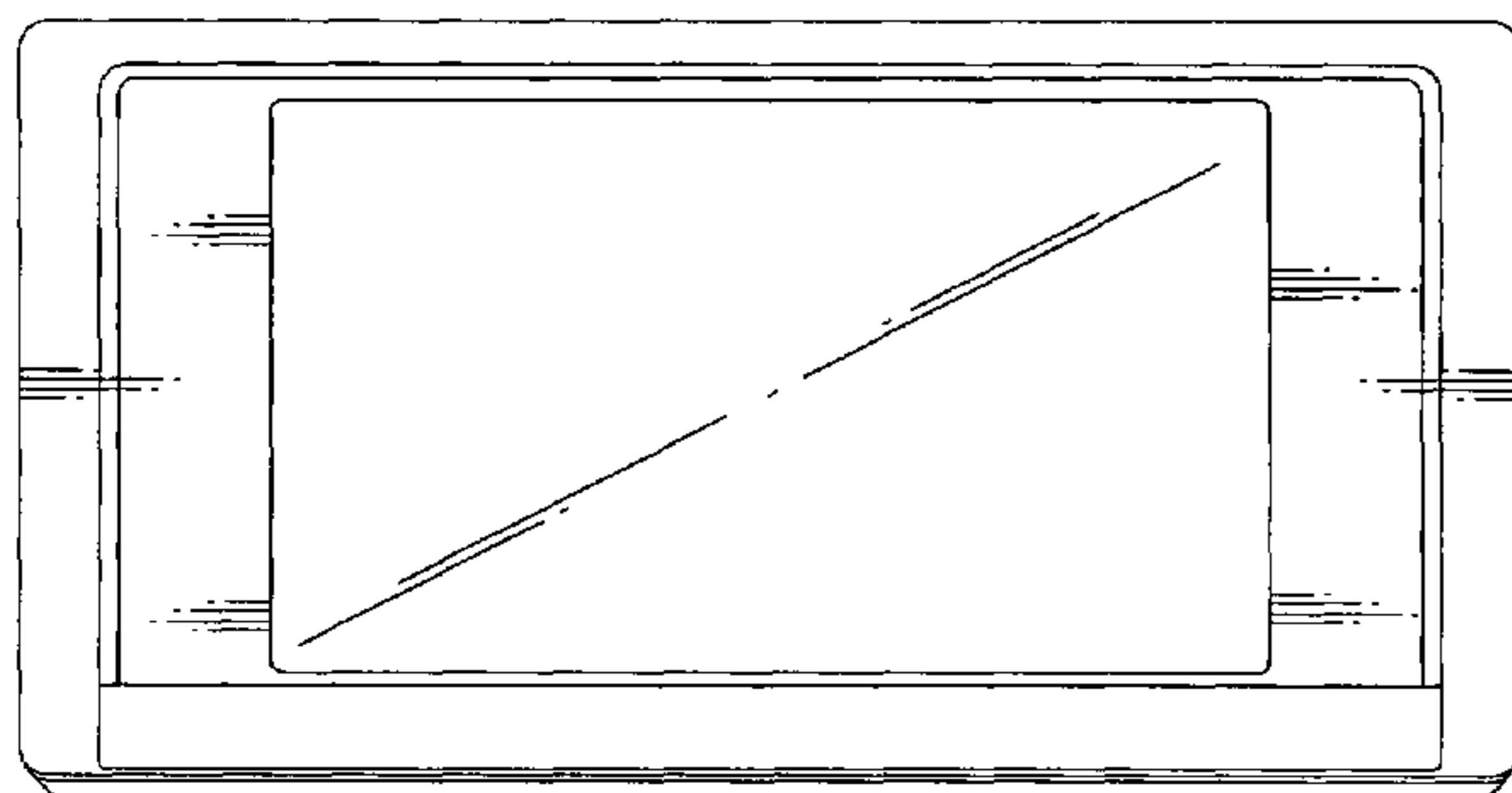

U.S. PATENT DOCUMENTS

D561,155 S * 2/2008 Kim et al. D14/138
D562,285 S * 2/2008 Lim D14/138
D562,292 S * 2/2008 Park D14/138
D563,938 S * 3/2008 Kim et al. D14/138
D565,978 S * 4/2008 Stevens et al. D10/65
D569,837 S * 5/2008 Baik et al. D14/138
2005/0107137 A1* 5/2005 Byun et al. 455/575.1
2007/0265031 A1* 11/2007 Koizumi et al. 455/556.1
2007/0287512 A1* 12/2007 Kilpi et al. 455/575.1

OTHER PUBLICATIONS

Philips S900, announced Jun. 2006, [online], [retrieved on Feb. 20, 2007]. Retrieved from Internet ,<URL: <http://www.gsmarena.com>>.*

HTC P4350, announced Nov. 2006, [online], [retrieved on Jun. 6, 2008]. Retrieved from Internet ,<URL: <http://www.gsmarena.com>>.*

Pantech Duo, announced Oct. 2007, [online], [retrieved on Jun. 6, 2008]. Retrieved from Internet ,<URL: <http://www.gsmarena.com>>.*

Samsung F490, announced Jan. 2008, [online], [retrieved on Jan. 18, 2008]. Retrieved from Internet ,<URL: <http://www.gsmarena.com>>.*

LG KF700, announced Feb. 2008, [online], [retrieved on Mar. 21, 2008]. Retrieved from Internet ,<URL: <http://www.gsmarena.com>>.*

* cited by examiner

FIG. 1

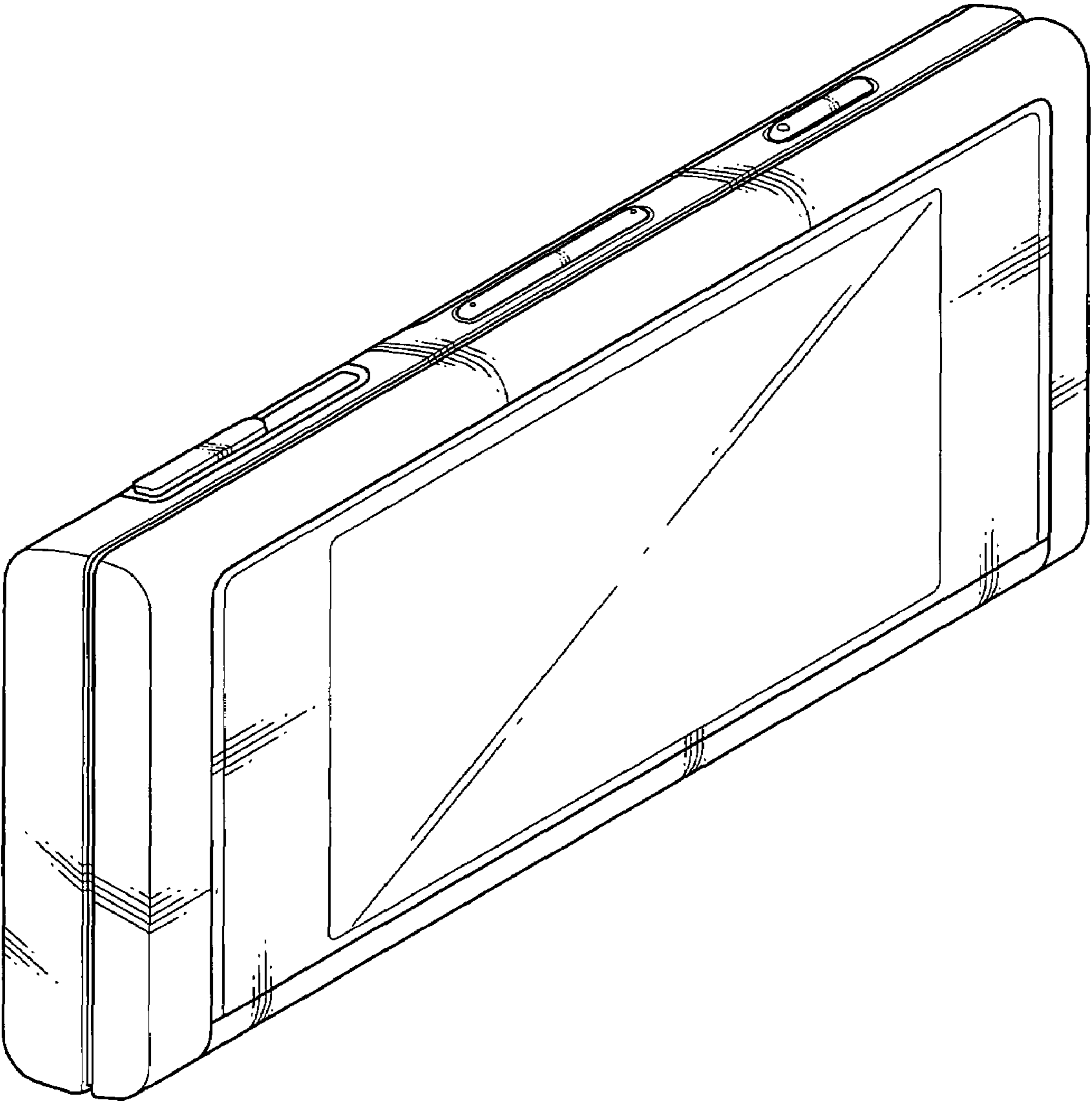

FIG. 2

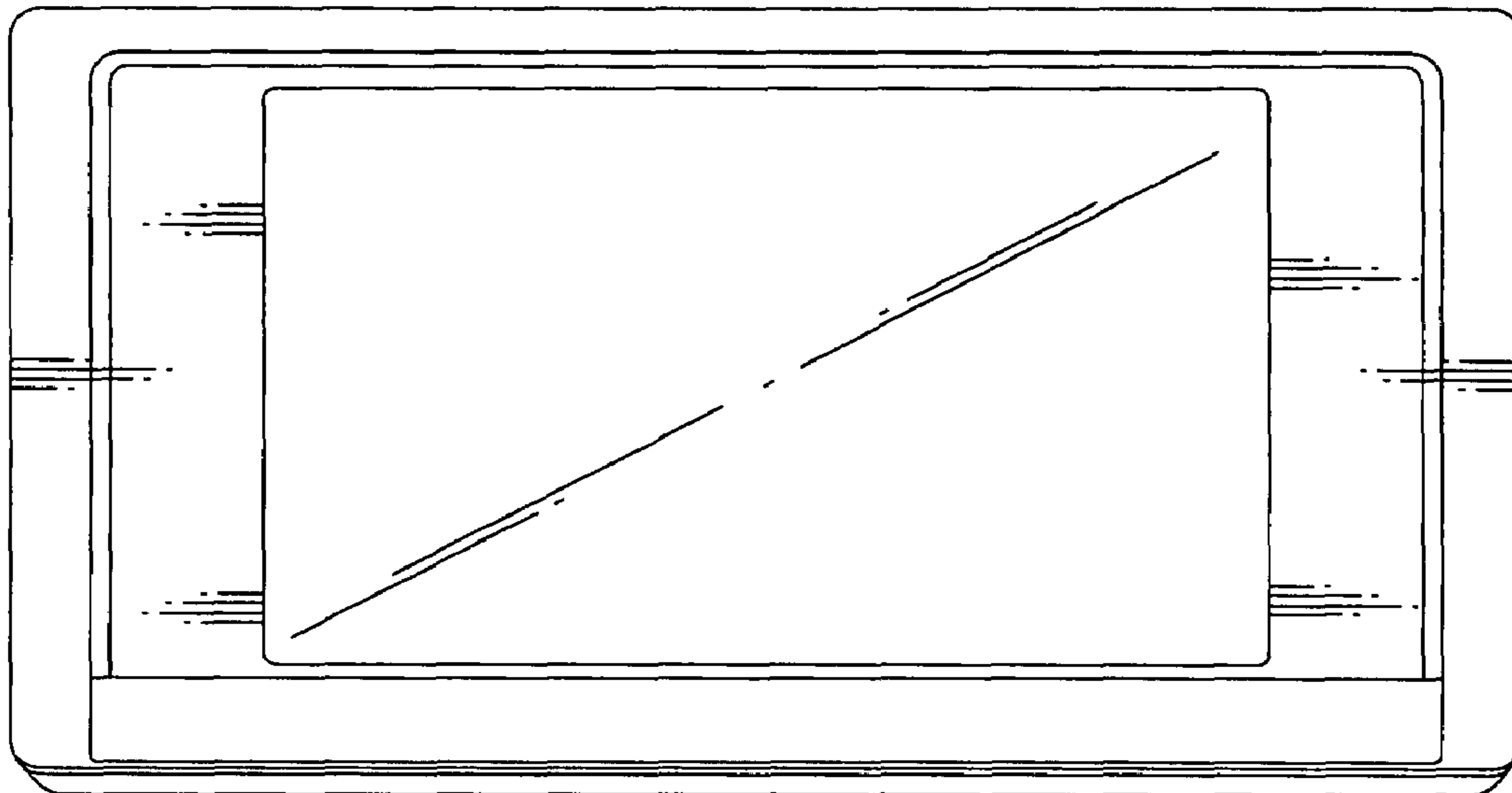

FIG. 3

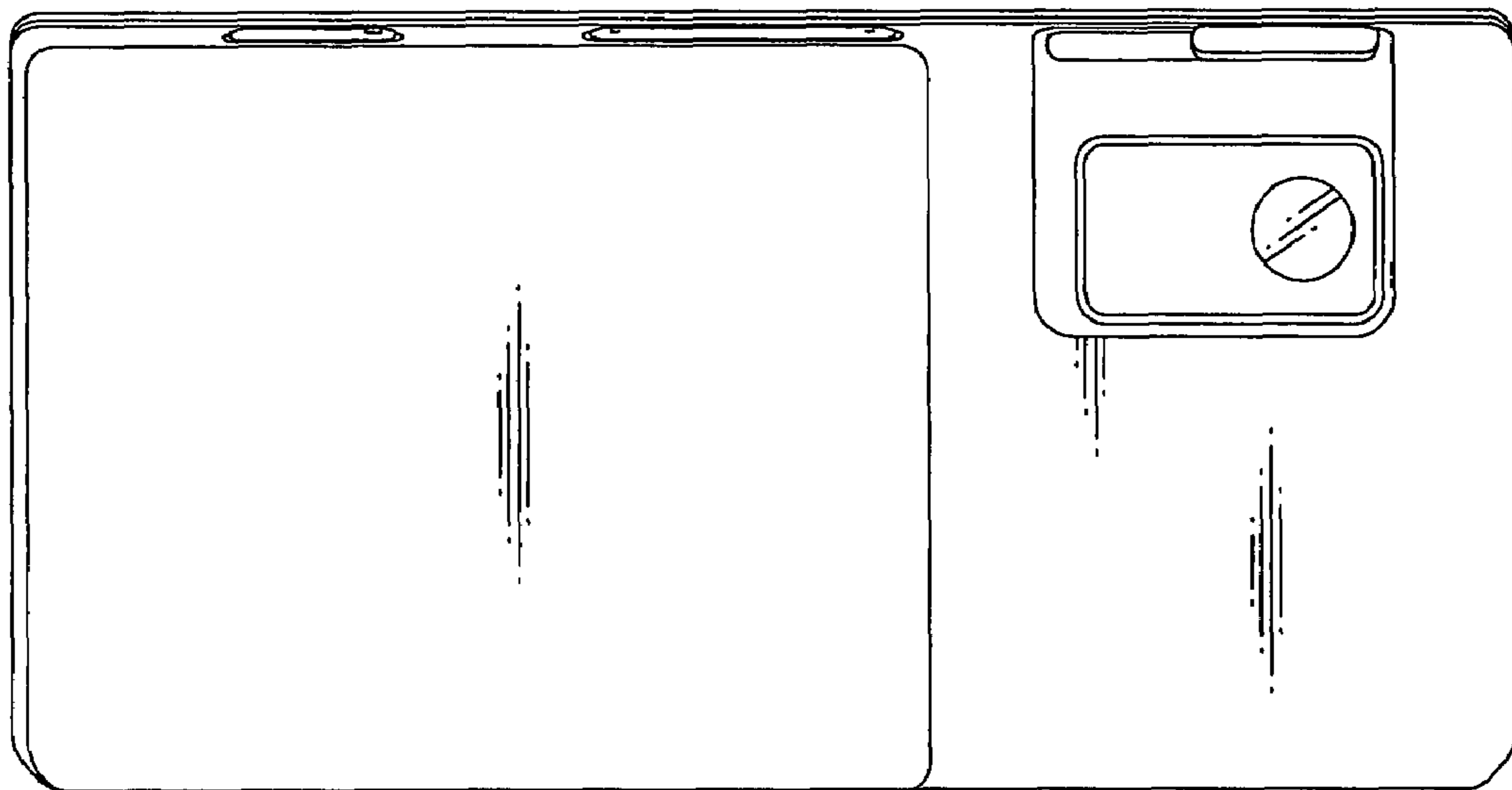

FIG. 4

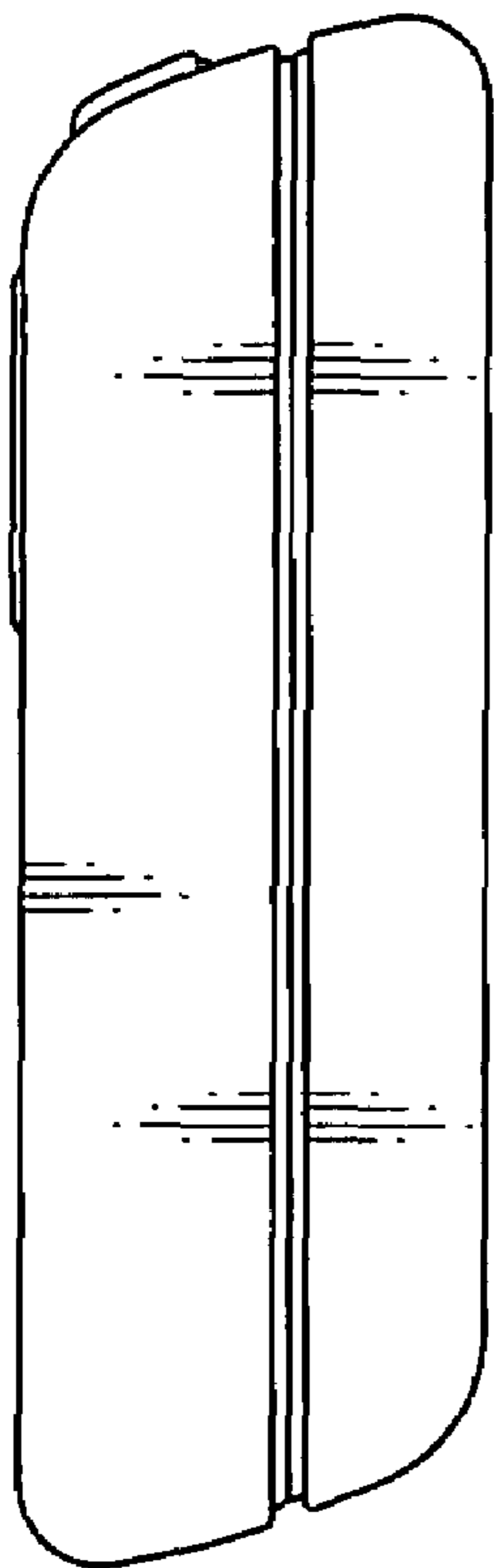

FIG. 5

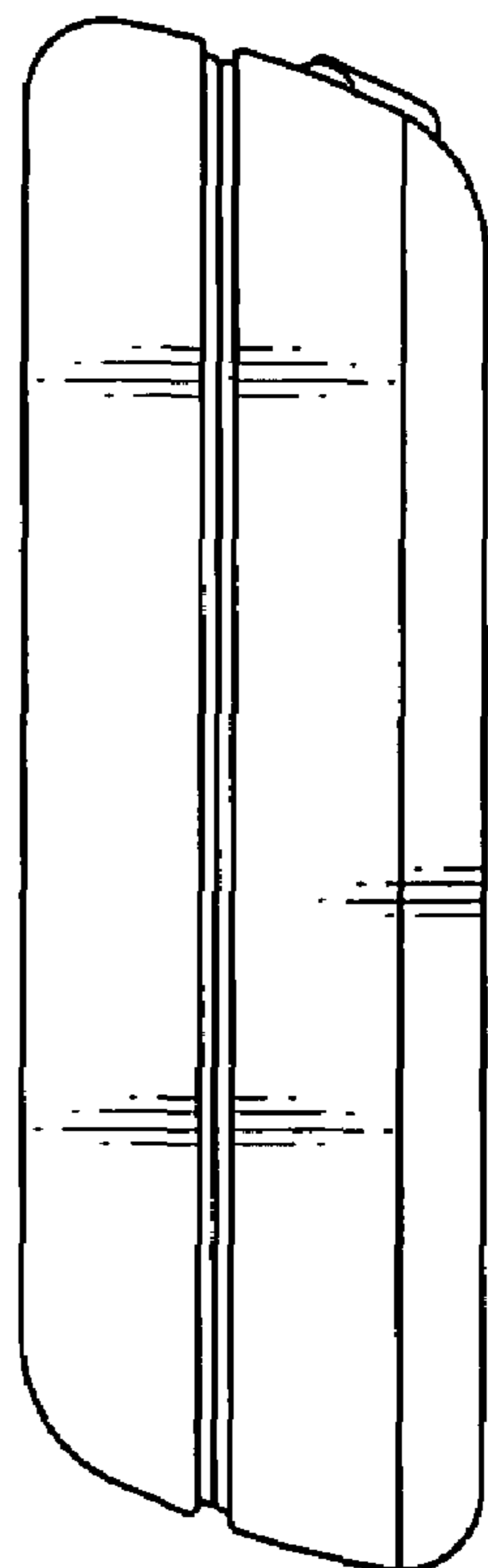

FIG. 6

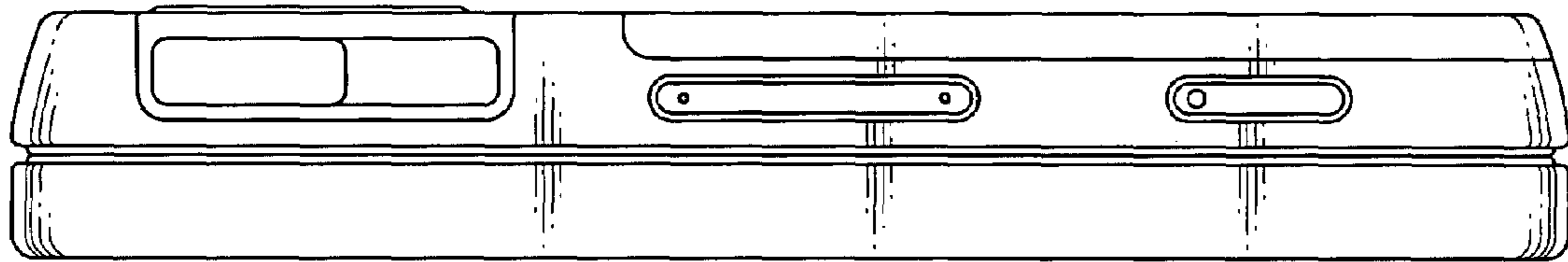

FIG. 7

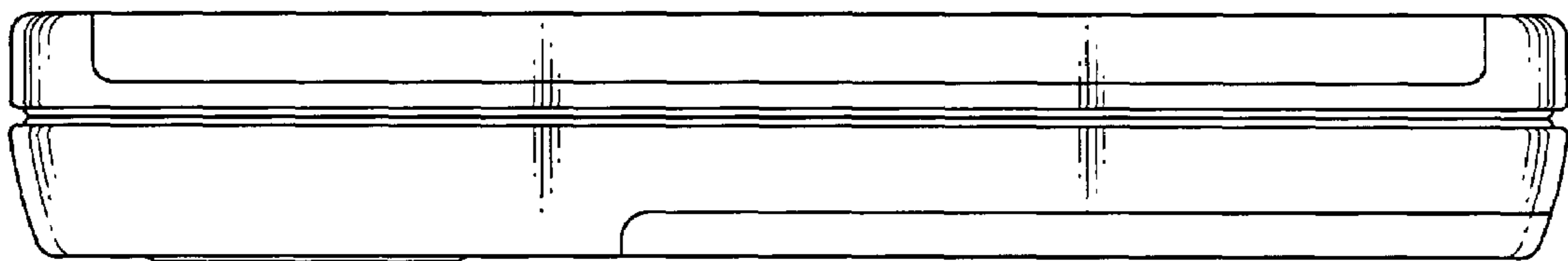

FIG. 8

