



US00D587629S

(12) **United States Design Patent**
Crijns

(10) **Patent No.:** **US D587,629 S**
(45) **Date of Patent:** **** Mar. 3, 2009**

(54) **CAR INCLUDING TOY-CAR, MOTOR CAR,
REPLICA CAR AND SCALE-MODEL CAR**

D550,124 S * 9/2007 Agullo Spottorno et al. . D12/92
D573,509 S * 7/2008 Lukusak et al. D12/92
D575,678 S * 8/2008 Matsumoto et al. D12/92
D576,523 S * 9/2008 Battams et al. D12/88

(75) Inventor: **Steven William Crijns**, Norwich (GB)

* cited by examiner

(73) Assignee: **Lotus Cars Limited**, Norfolk (GB)

Primary Examiner—Melody N Brown

(**) Term: **14 Years**

(74) *Attorney, Agent, or Firm*—Fulwider Patton LLP

(21) Appl. No.: **29/317,362**

(57) **CLAIM**

(22) Filed: **Apr. 28, 2008**

The ornamental design for a car including toy-car, motor car, replica car and scale-model car, as shown and described.

(30) **Foreign Application Priority Data**

Oct. 29, 2007 (EM) 000819164-001

DESCRIPTION

(51) **LOC (9) Cl.** **12-08**

FIG. 1 is a top plan view of the design for a car including toy-car, motor car, replica car and scale-model car, showing my new design.

(52) **U.S. Cl.** **D12/88; D12/92**

FIG. 2 is a bottom plan view thereof.

(58) **Field of Classification Search** D12/86,
D12/90-92; D21/424, 433, 548-550; 296/181.1,
296/181.5

FIG. 3 is a left side elevational view thereof.

See application file for complete search history.

FIG. 4 is a right side elevational view thereof.

(56) **References Cited**

FIG. 5 is a front view thereof; and,

U.S. PATENT DOCUMENTS

FIG. 6 is a rear view thereof.

D521,904 S 5/2006 Moruzzi

1 Claim, 2 Drawing Sheets

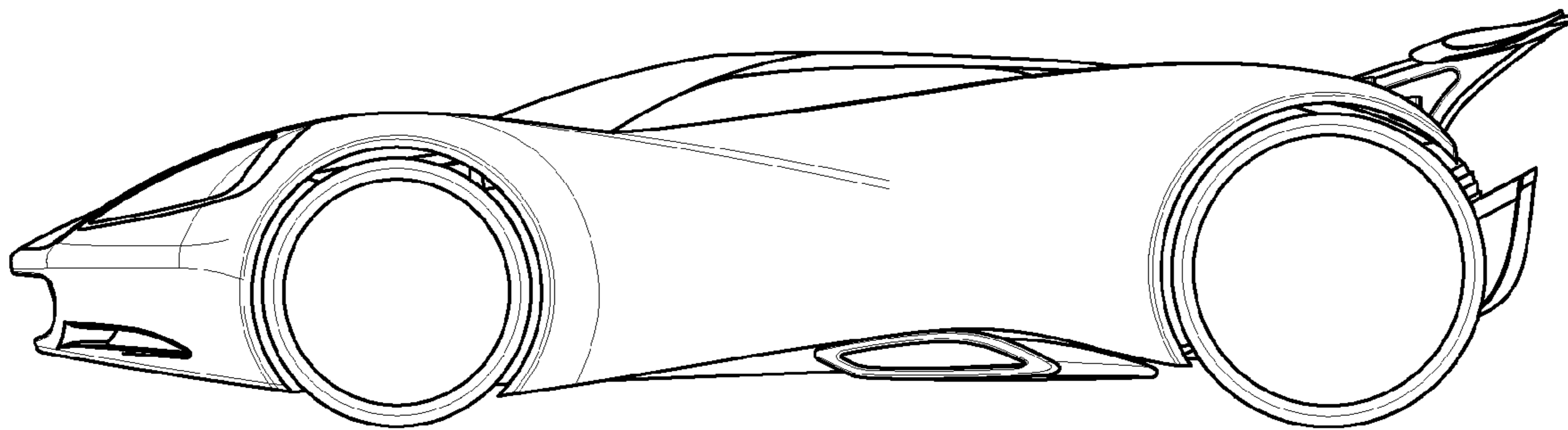

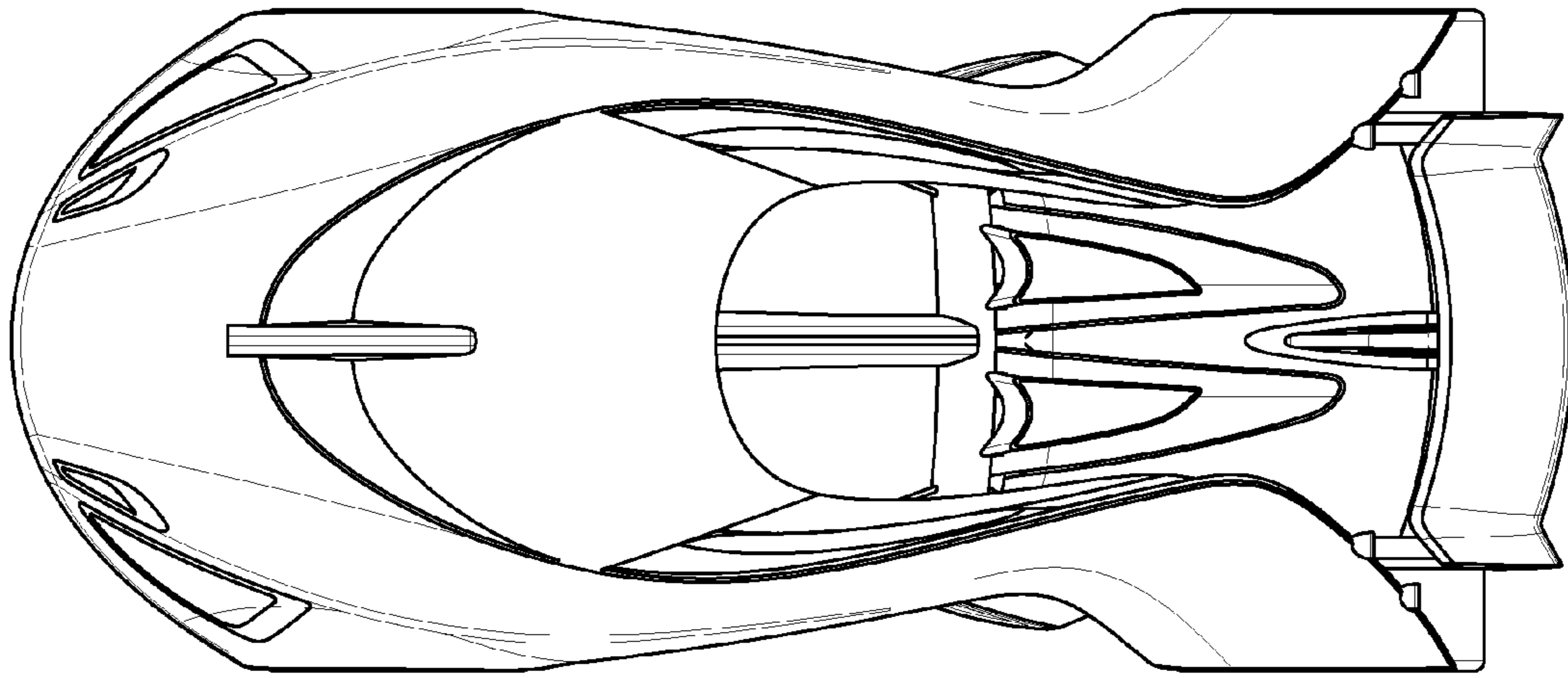

FIG. 1

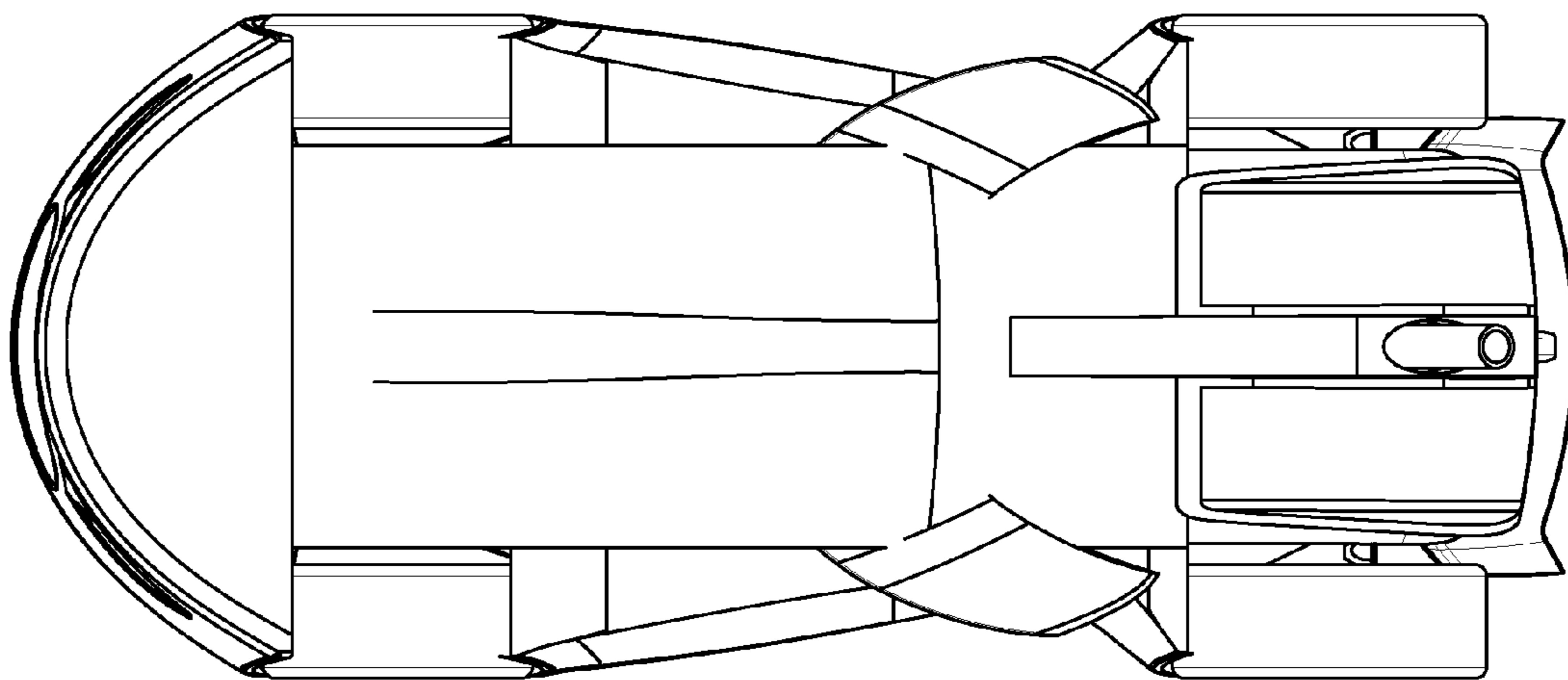

FIG. 2

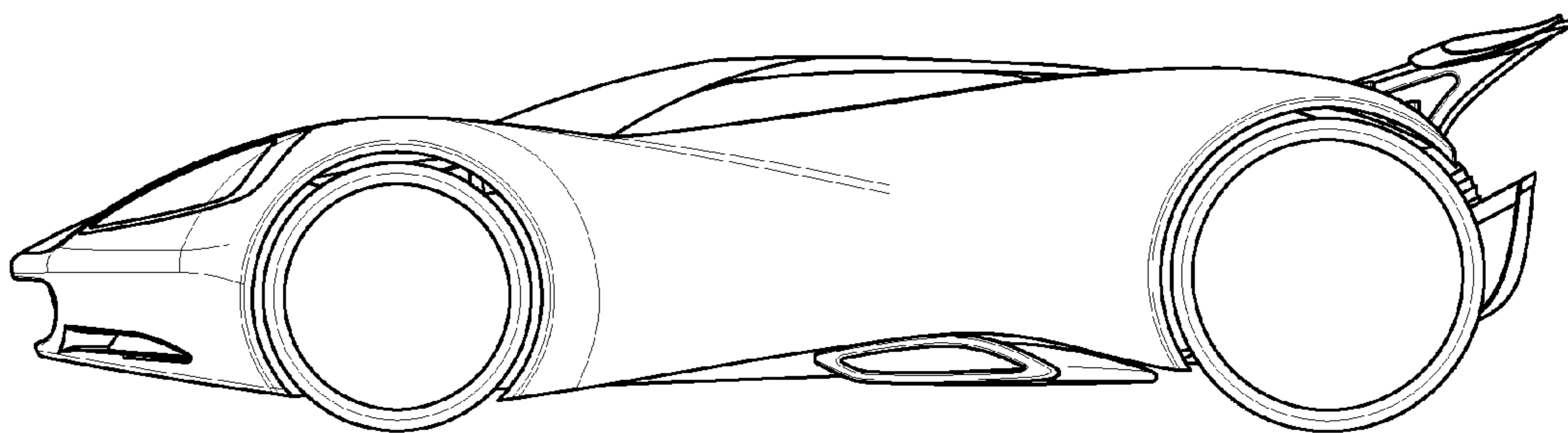

FIG. 3

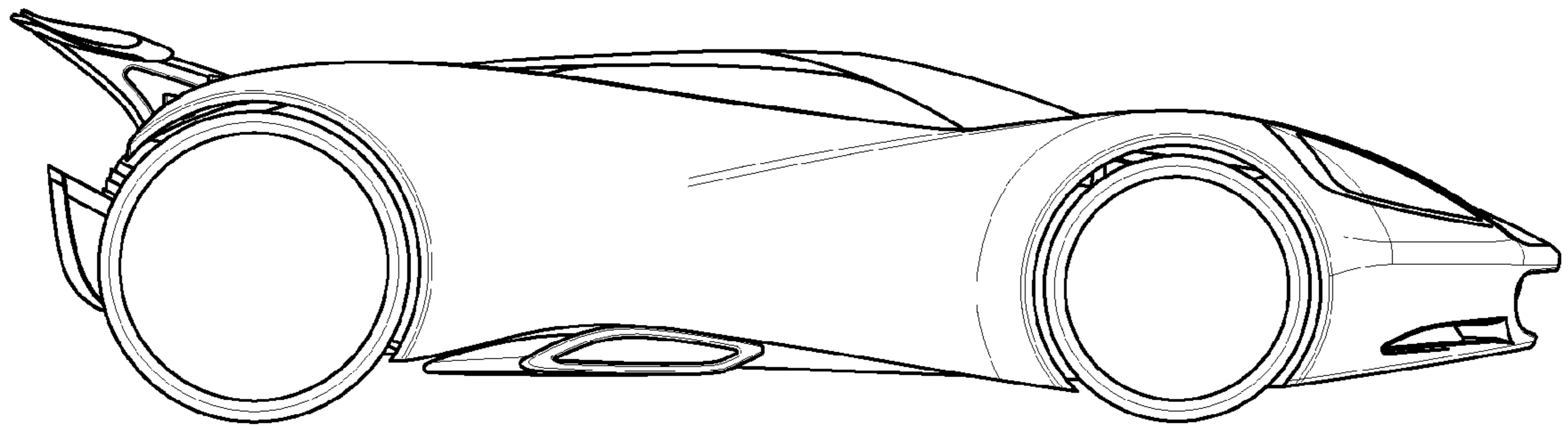

FIG. 4

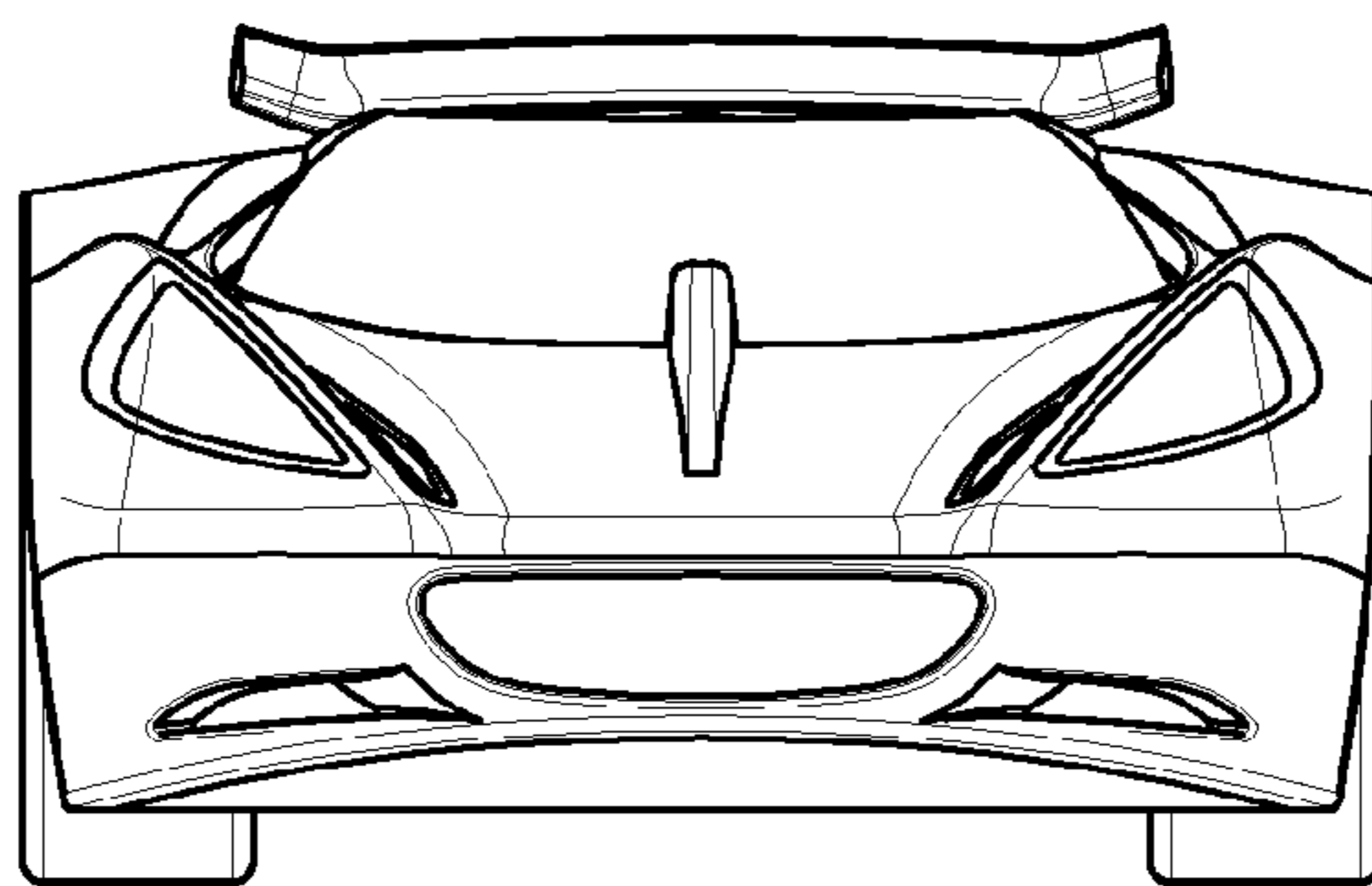

FIG. 5

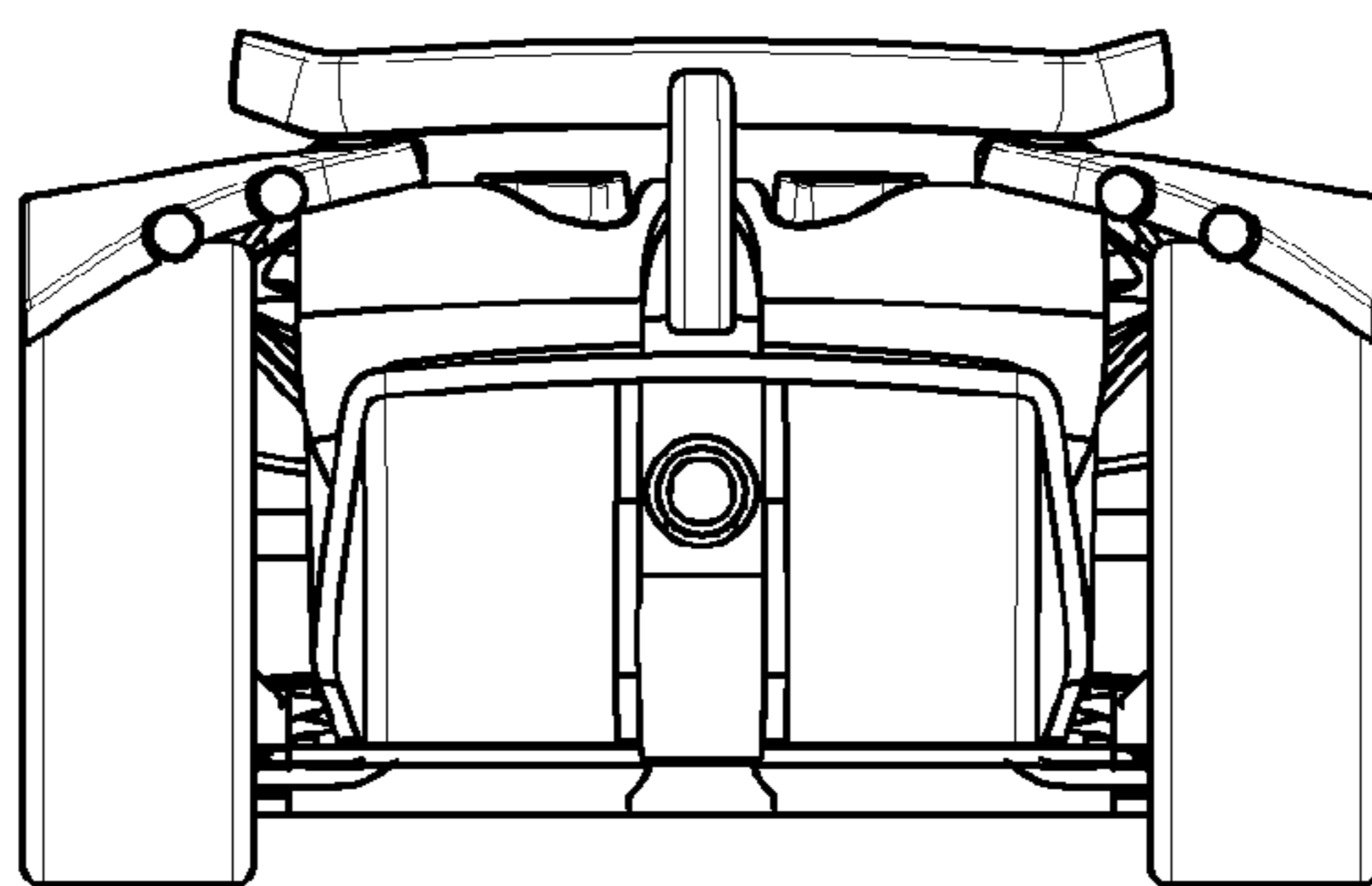

FIG. 6