



US00D587559S

(12) **United States Design Patent**
Jones et al.

(10) **Patent No.:** **US D587,559 S**
(45) **Date of Patent:** **** Mar. 3, 2009**

(54) **GEODESIC HUB**

5,499,883 A * 3/1996 Heinzl 403/219

(76) Inventors: **Wendell L. Jones**, 6508 Caballero Pkwy.
NW., Albuquerque, NM (US) 87107;
Howard G. Jones, 621 Tyler NW.,
Albuquerque, NM (US) 87107; **Rodney**
Ward, 1901 S. 2nd St., Tucumcari, NM
(US) 88401

* cited by examiner

Primary Examiner—Holly H Baynham
(74) *Attorney, Agent, or Firm*—Janeen Vilven-Doggett;
Peacock Myers, P.C.

(**) Term: **14 Years**

(21) Appl. No.: **29/282,098**

(22) Filed: **Jul. 11, 2007**
(Under 37 CFR 1.47)

(51) **LOC (9) Cl.** **08-05**

(52) **U.S. Cl.** **D8/349**

(58) **Field of Classification Search** D8/349,
D8/354, 382; 403/218–219, 403, 171, 169,
403/172; 52/81.3

See application file for complete search history.

(56) **References Cited**

U.S. PATENT DOCUMENTS

3,844,664	A *	10/1974	Hogan	403/171
3,857,212	A *	12/1974	Barnett	52/81.3
4,384,801	A *	5/1983	Hamel	403/172
4,511,278	A *	4/1985	Robinson	403/172
4,921,369	A *	5/1990	Chew et al.	403/171

(57) **CLAIM**

The ornamental design for a geodesic hub, as shown and described.

DESCRIPTION

FIG. 1 is a top view of a six spoke geodesic hub;
FIG. 2 is a back view thereof, the front side view being a mirror image thereof;
FIG. 3 is a right side view thereof, the left side being a mirror image thereof;
FIG. 4 is a bottom view thereof;
FIG. 5 is a perspective view thereof;
FIG. 6 is a top view of a five spoke geodesic hub thereof;
FIG. 7 is a front view thereof;
FIG. 8 is a back view thereof;
FIG. 9 is a bottom view thereof; and,
FIG. 10 is a perspective view thereof.

1 Claim, 4 Drawing Sheets

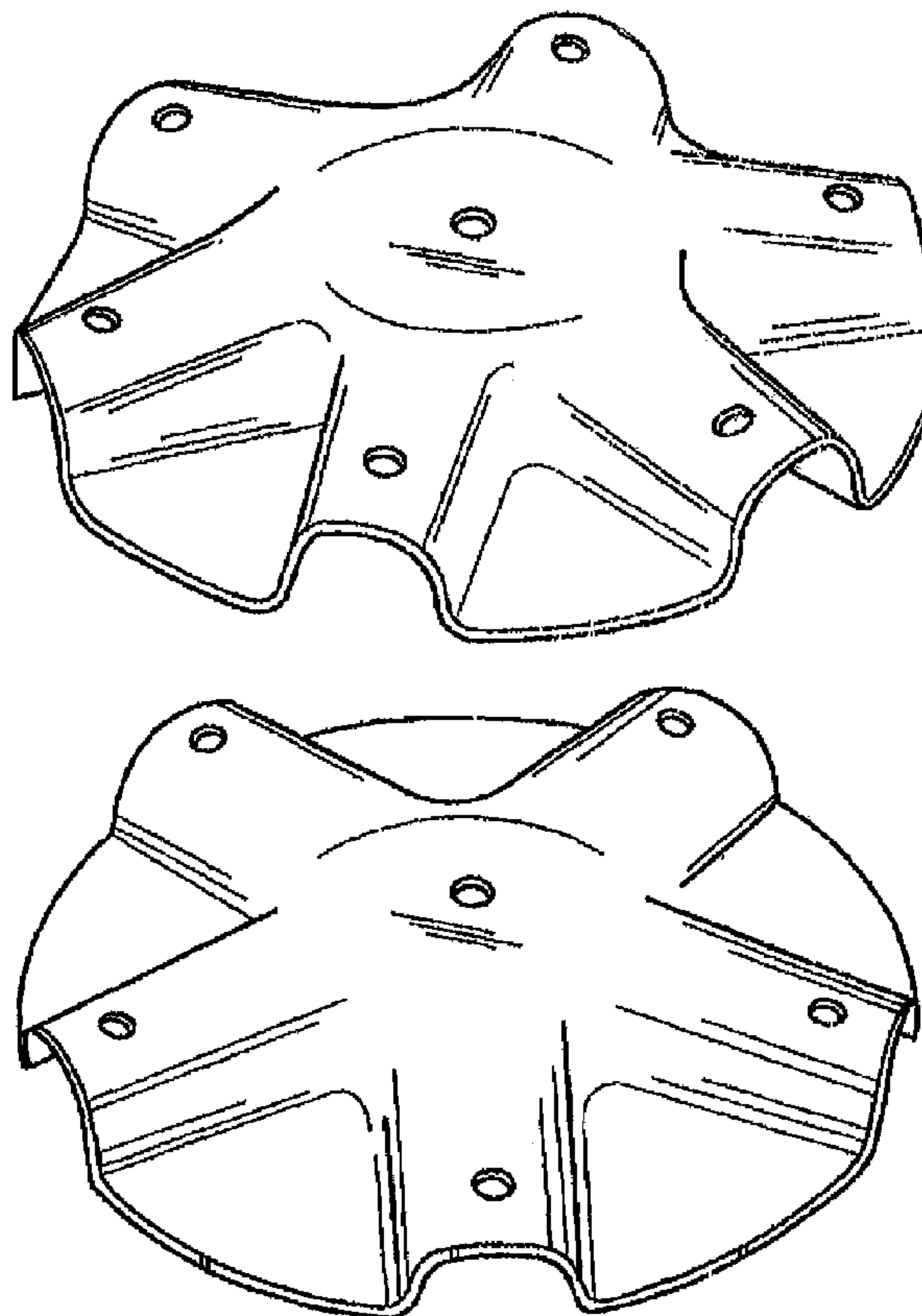

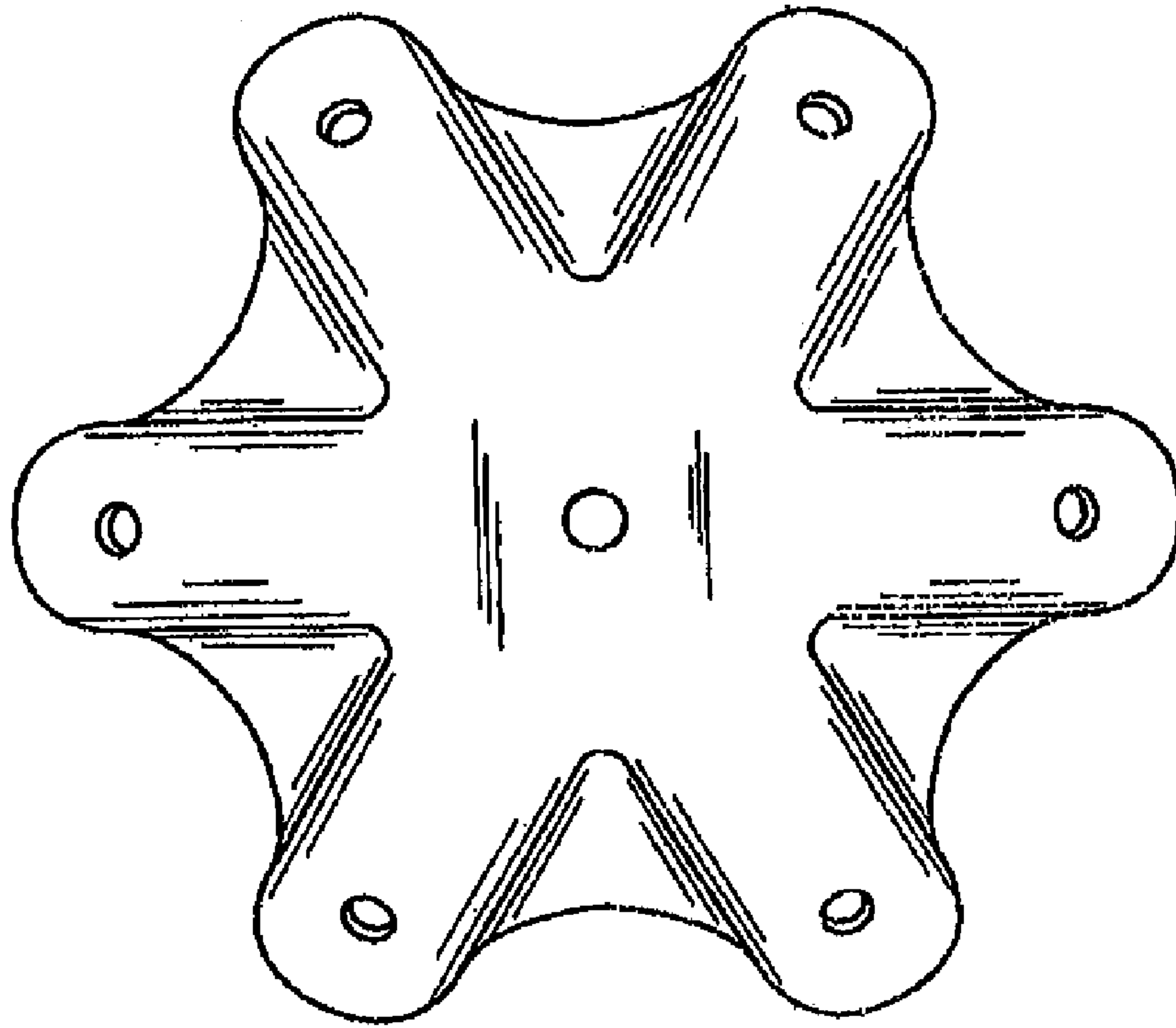

FIG. 1

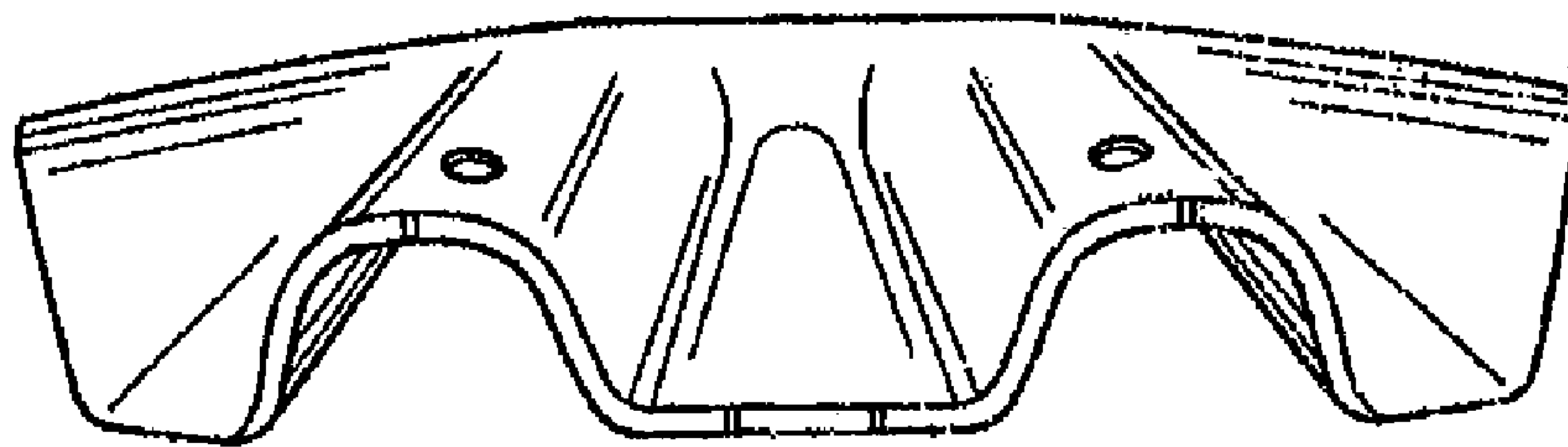

FIG. 2

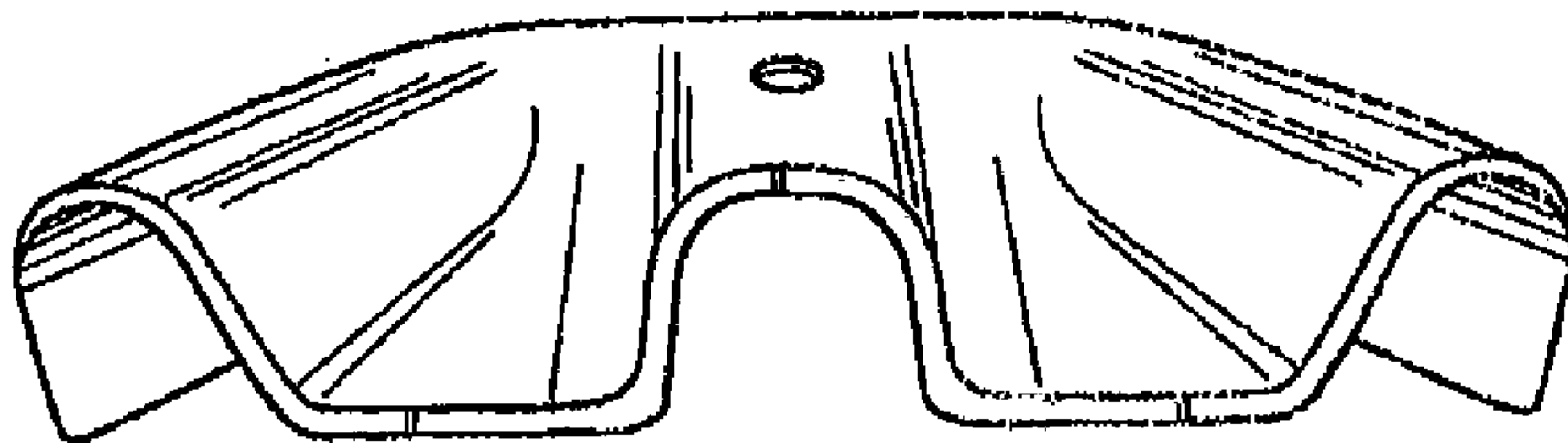

FIG. 3

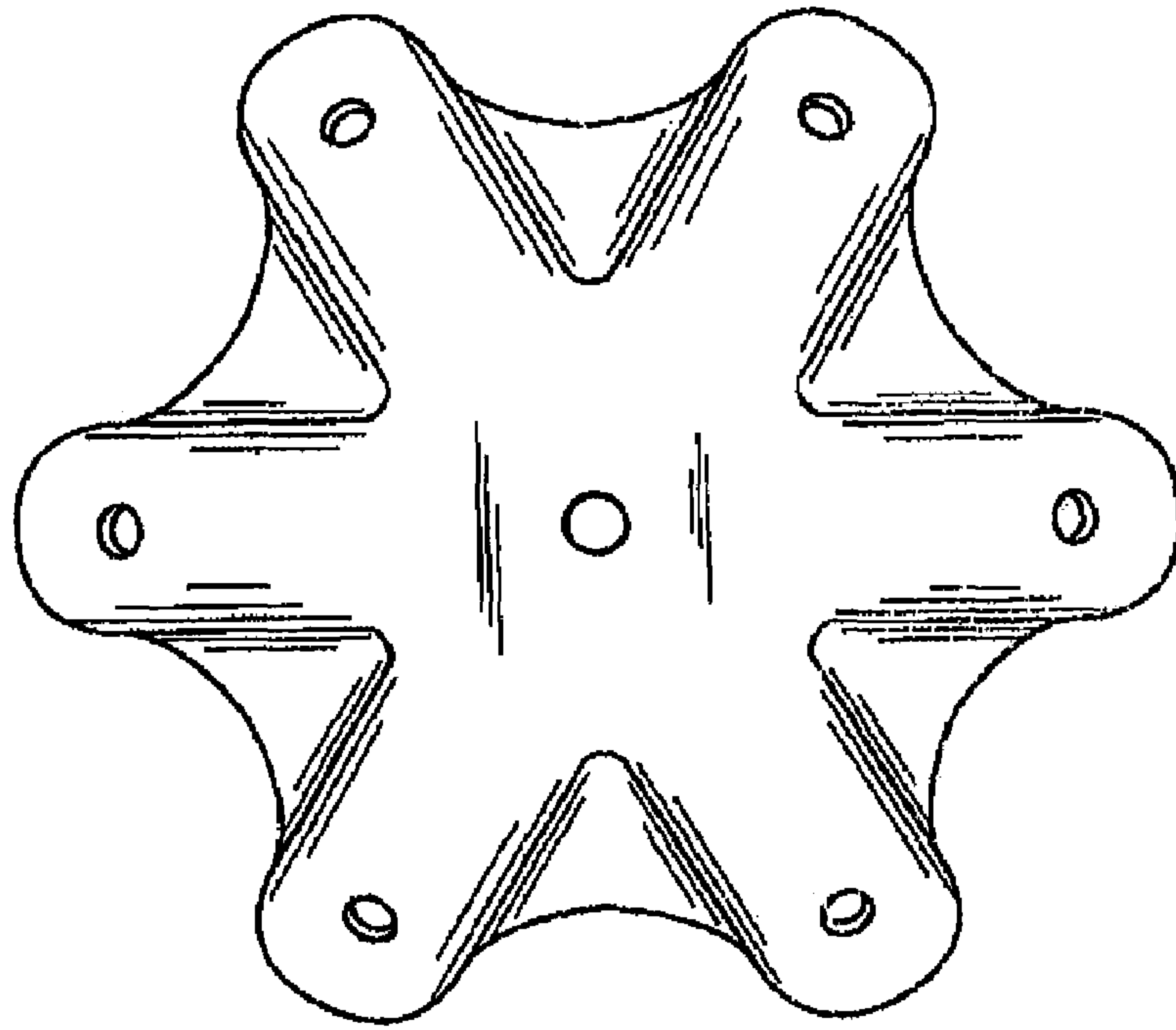

FIG. 4

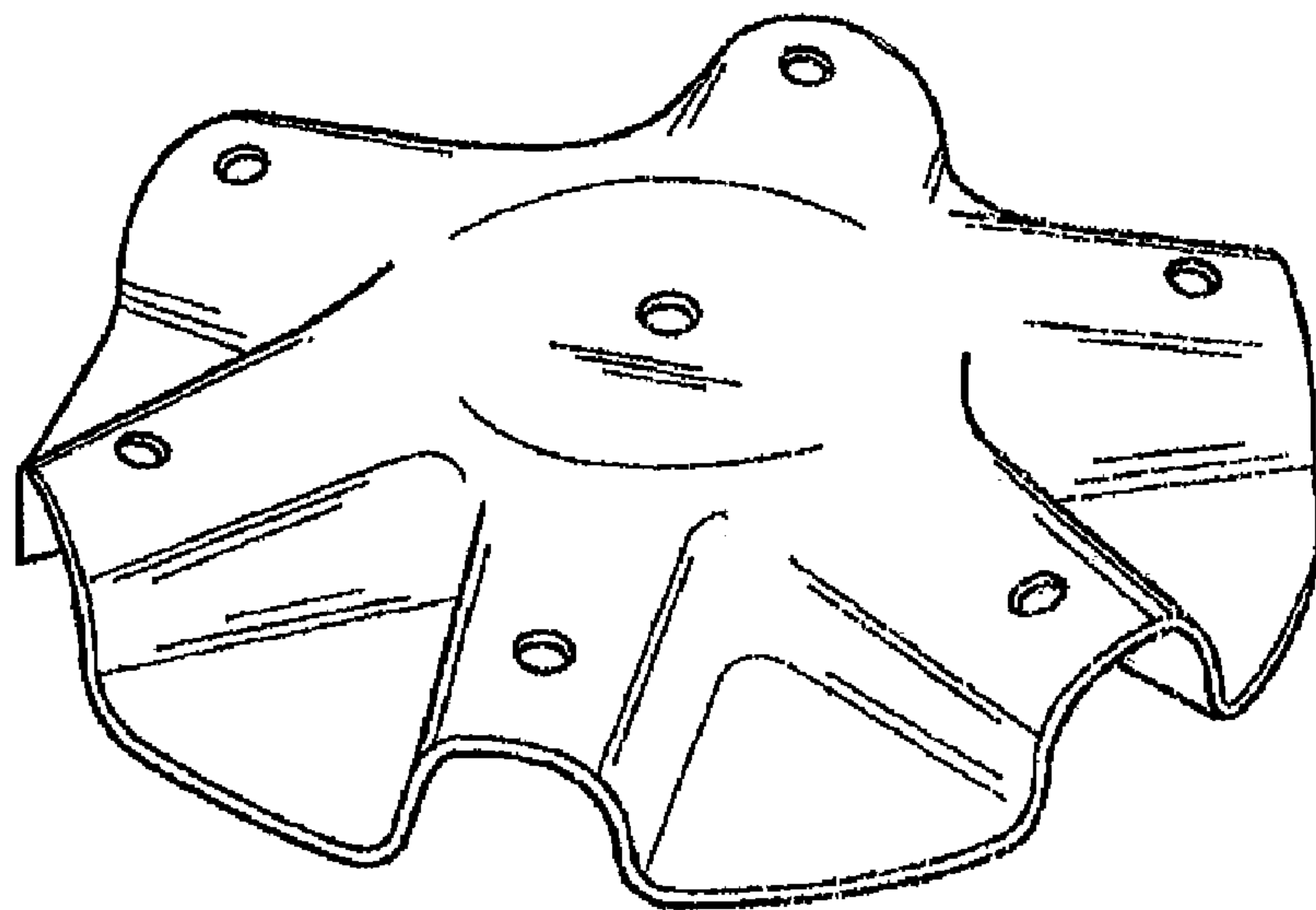

FIG. 5

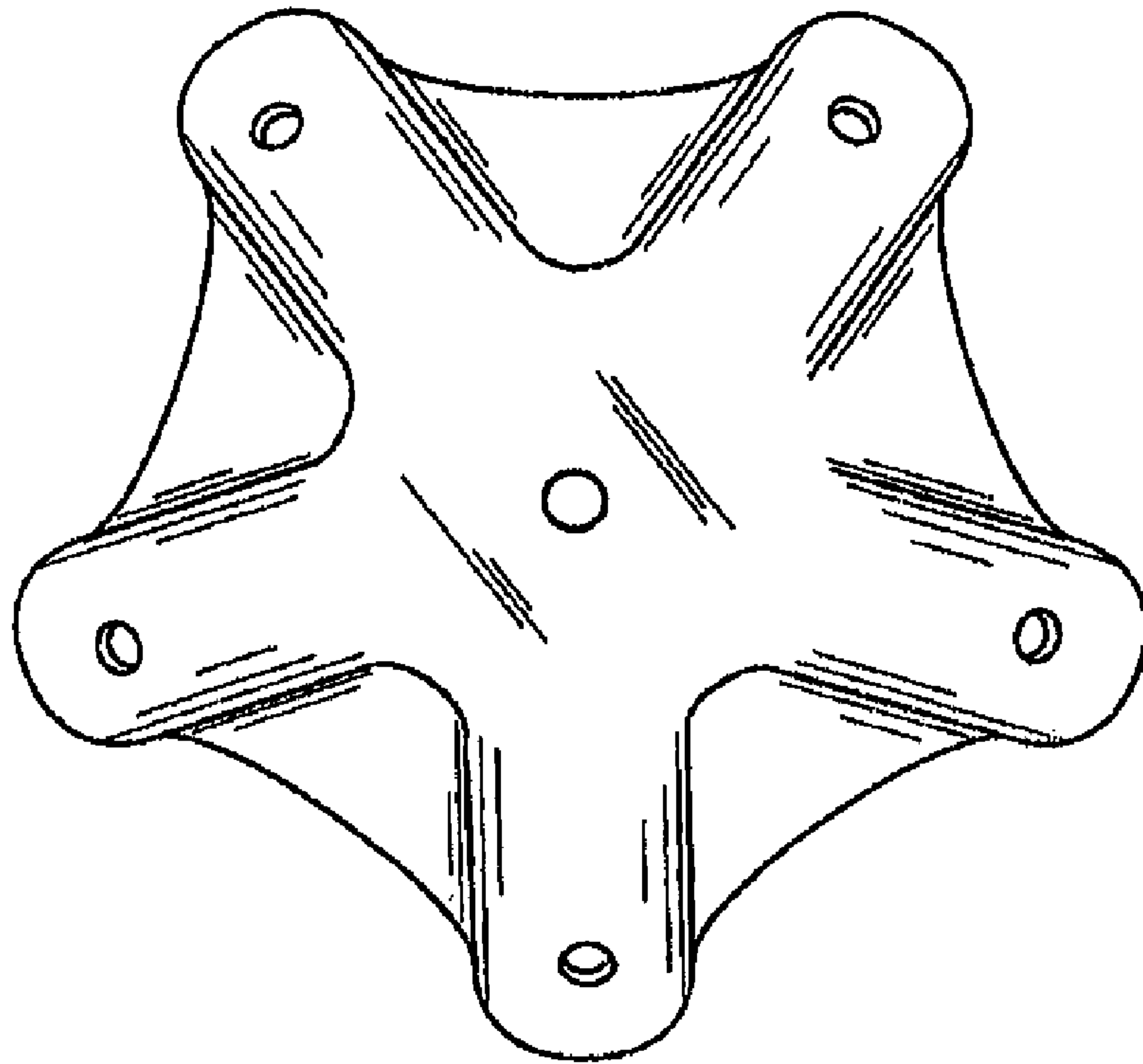

FIG. 6

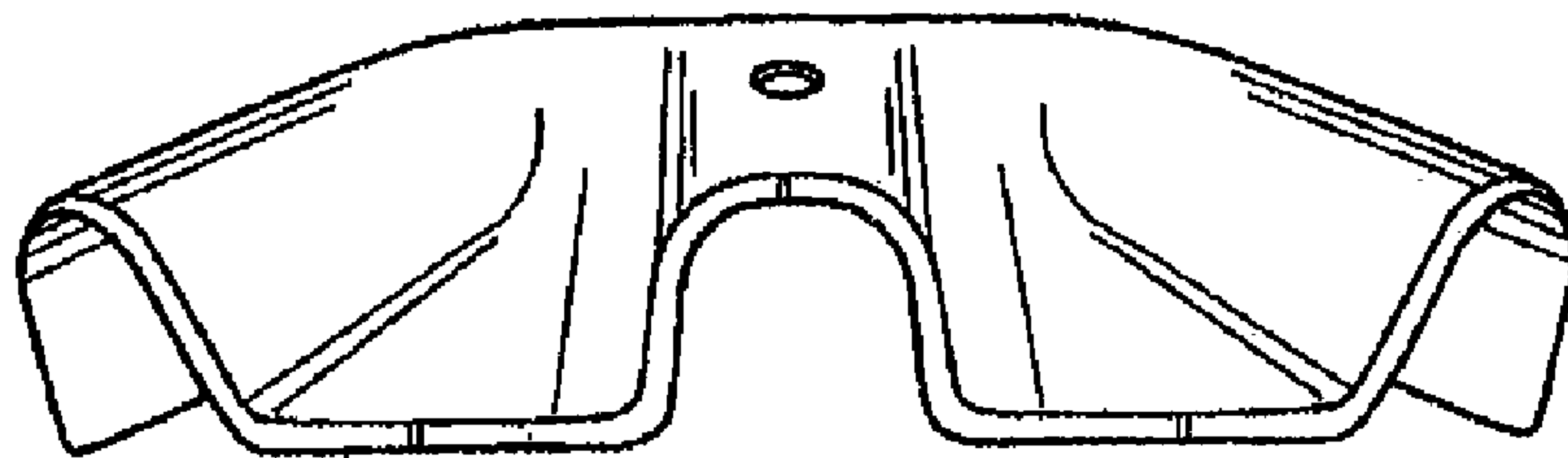

FIG. 7

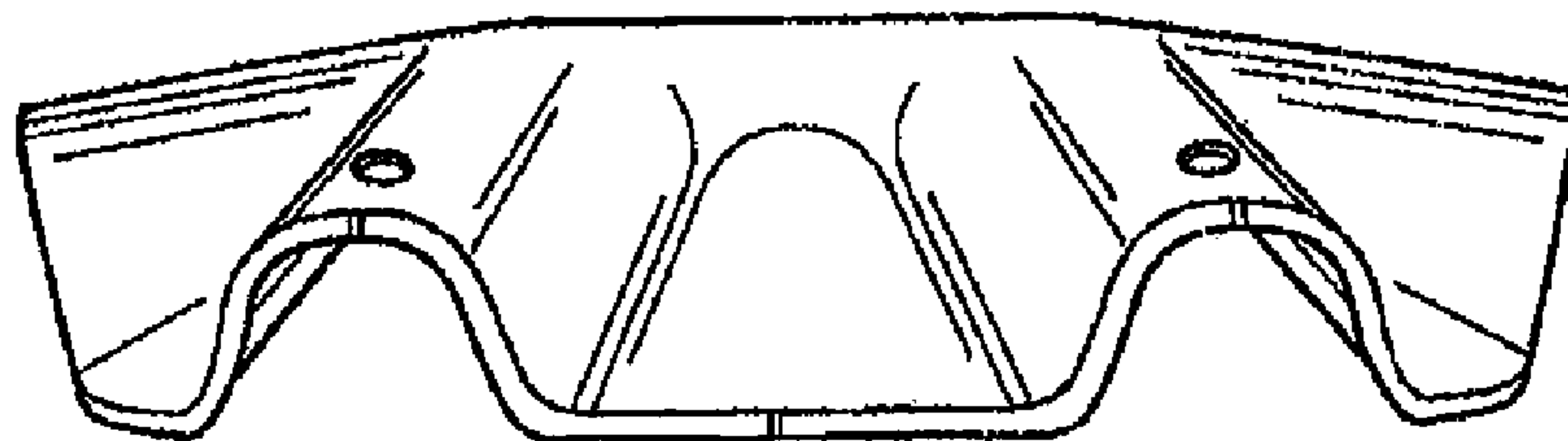

FIG. 8

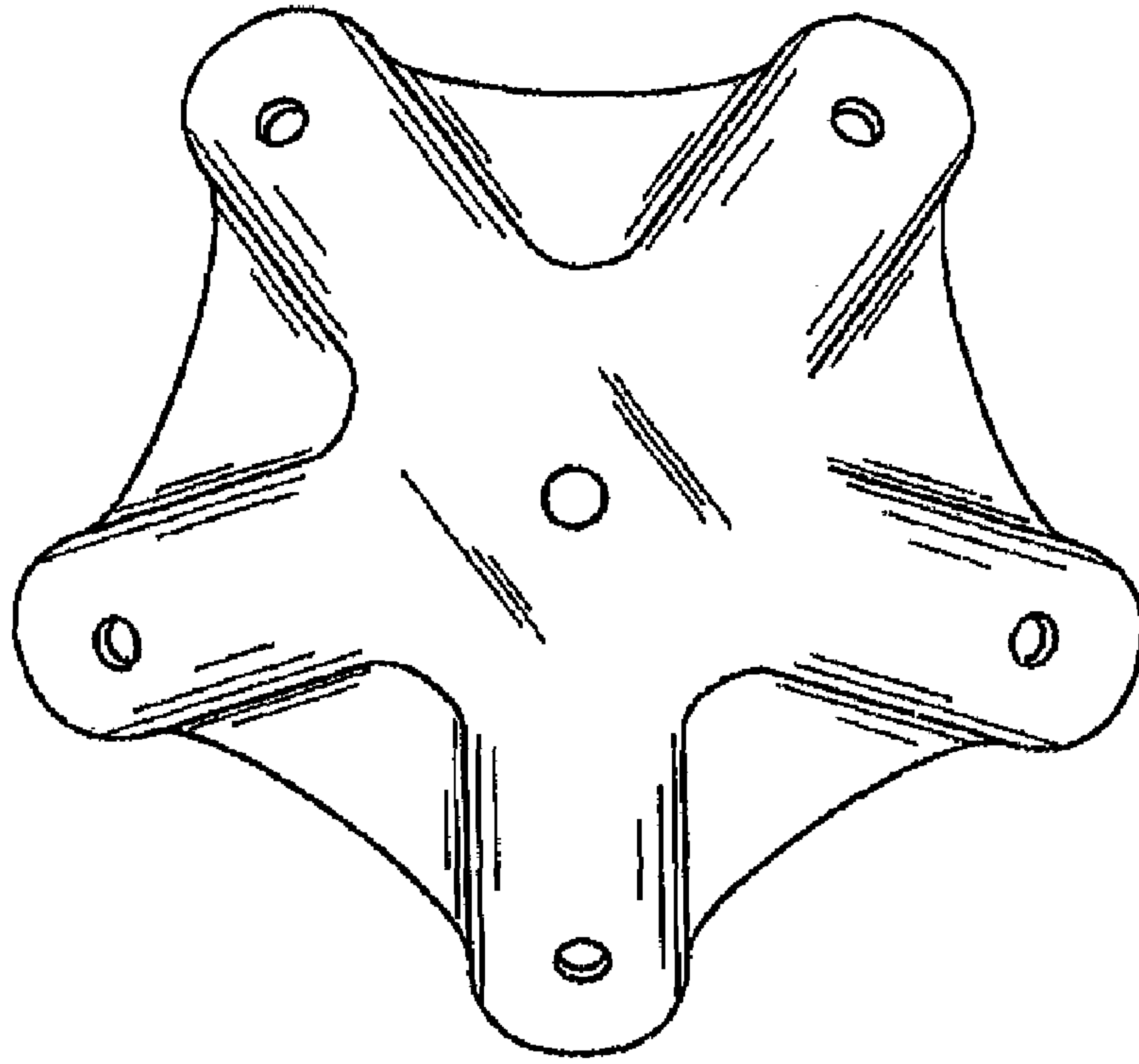

FIG. 9

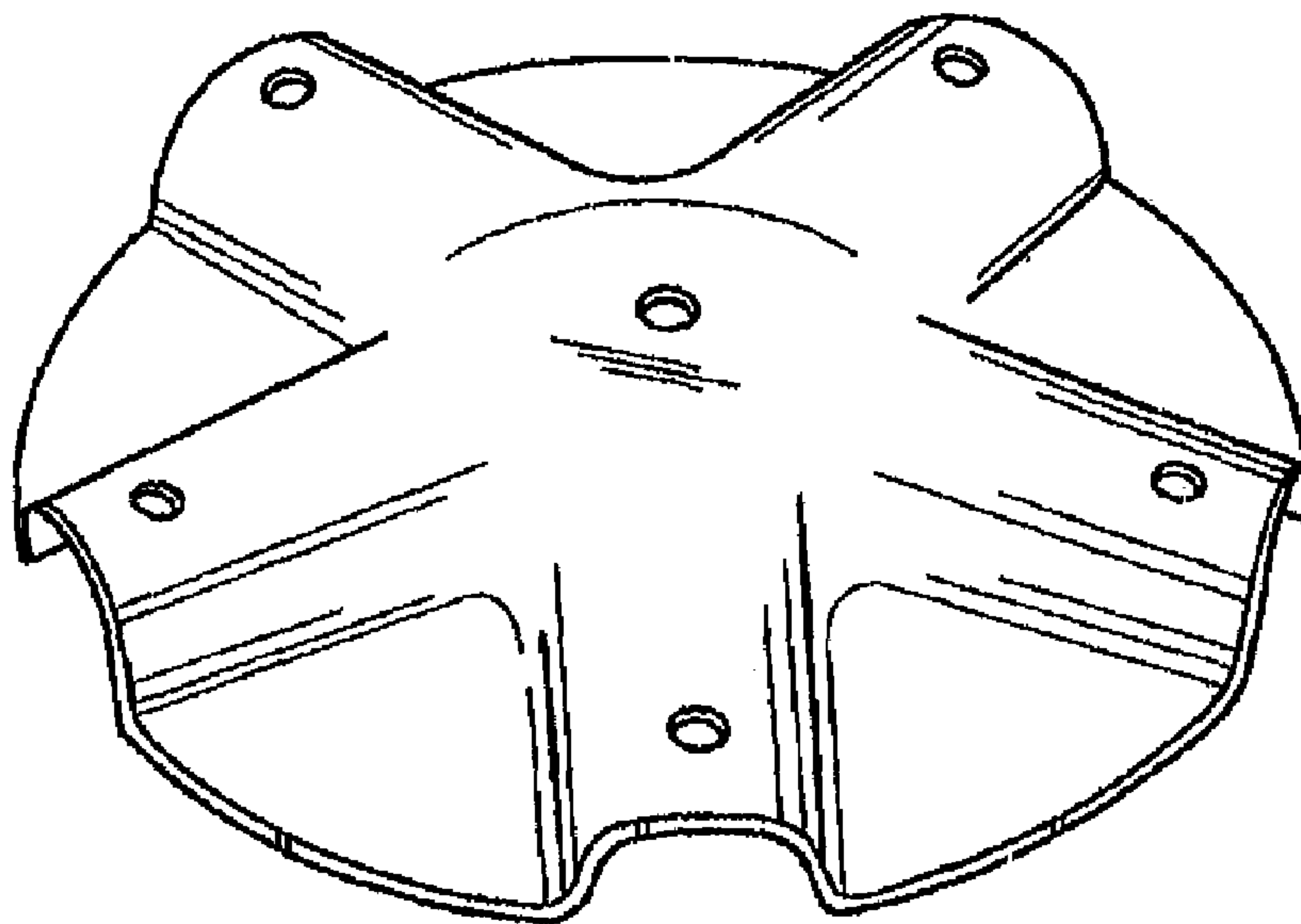

FIG. 10