



US00D587453S

(12) **United States Design Patent**
Burkhard et al.

(10) **Patent No.:** **US D587,453 S**
(45) **Date of Patent:** **** Mar. 3, 2009**

(54) **STORAGE BOX FOR CALIBRATION WEIGHTS**

(75) Inventors: **Hans-Joerg Burkhard**, Wolfhausen (CH); **Yves Marmier**, La Chaux-de-Fonds (CH)

(73) Assignee: **Mettler-Toledo AG**, Greifensee (CH)

(**) Term: **14 Years**

(21) Appl. No.: **29/298,980**

(22) Filed: **Dec. 17, 2007**

(30) **Foreign Application Priority Data**

Jul. 9, 2007 (EM) 000754031

(51) **LOC (9) Cl.** **03-01**

(52) **U.S. Cl.** **D3/282; D3/294**

(58) **Field of Classification Search** D3/272-273, D3/276, 282, 284, 286, 294-295, 905; D6/432; D7/605; D9/423; 206/349, 372-373, 569, 206/572, 576, 581

See application file for complete search history.

(56) **References Cited**

U.S. PATENT DOCUMENTS

D249,701 S *	9/1978	Maples et al.	D23/207
D258,866 S *	4/1981	Houseman et al.	D9/742
D324,154 S *	2/1992	Embree	D7/605
D333,783 S *	3/1993	Perugini	D9/424
D341,294 S *	11/1993	Doxey	D3/291
D349,628 S *	8/1994	Kahl et al.	D7/605
D355,849 S *	2/1995	Trower et al.	D9/424
D373,247 S *	9/1996	Dickinson et al.	D3/282
5,575,401 A *	11/1996	Trower et al.	220/522

* cited by examiner

Primary Examiner—Robert M Spear
Assistant Examiner—Roselynn Cody
(74) *Attorney, Agent, or Firm*—Stanley Law Group LLP

(57) **CLAIM**

The ornamental design for a box for calibration weights, as shown and described.

DESCRIPTION

FIG. 1 is a top-left perspective view of the storage box for calibration weights, wherein the broken lines illustrate the location of a latch which is not part of the claimed design;

FIG. 2 is a left side elevation view thereof, the right side view being a mirror image;

FIG. 3 is a front elevation view thereof;

FIG. 4 is a rear elevation view thereof;

FIG. 5 is a top plan view thereof; and,

FIG. 6 is a bottom plan view thereof;

FIG. 7 is a top-left perspective view of the storage box for calibration in an alternate condition of use, wherein the broken lines illustrate the location of latches which are not part of the claimed design;

FIG. 8 is a left side elevation view thereof, the right side view being a mirror image;

FIG. 9 is a front elevation view thereof;

FIG. 10 is a rear elevation view of thereof;

FIG. 11 is a top plan view thereof; and,

FIG. 12 is a bottom plan view thereof.

1 Claim, 2 Drawing Sheets

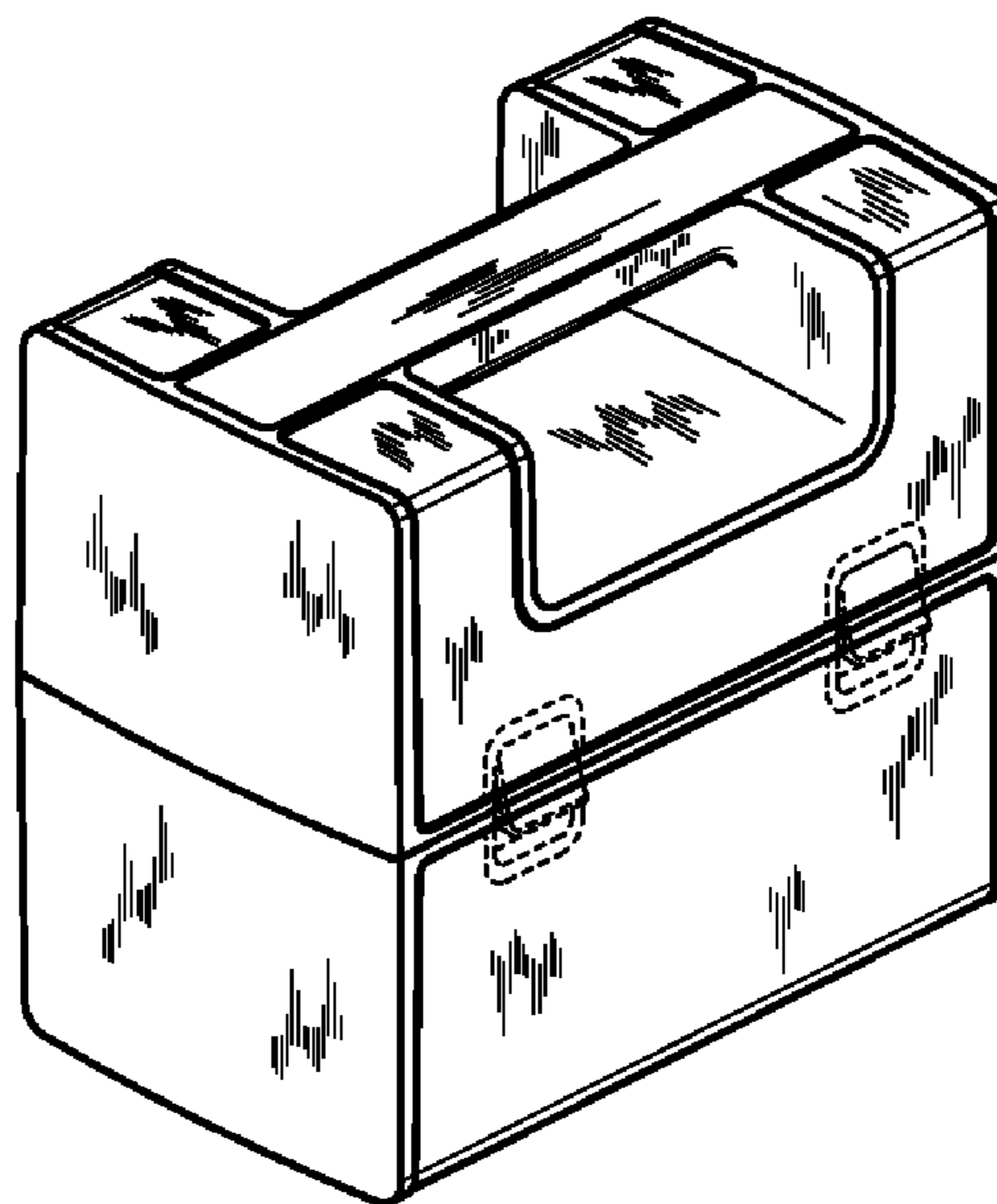
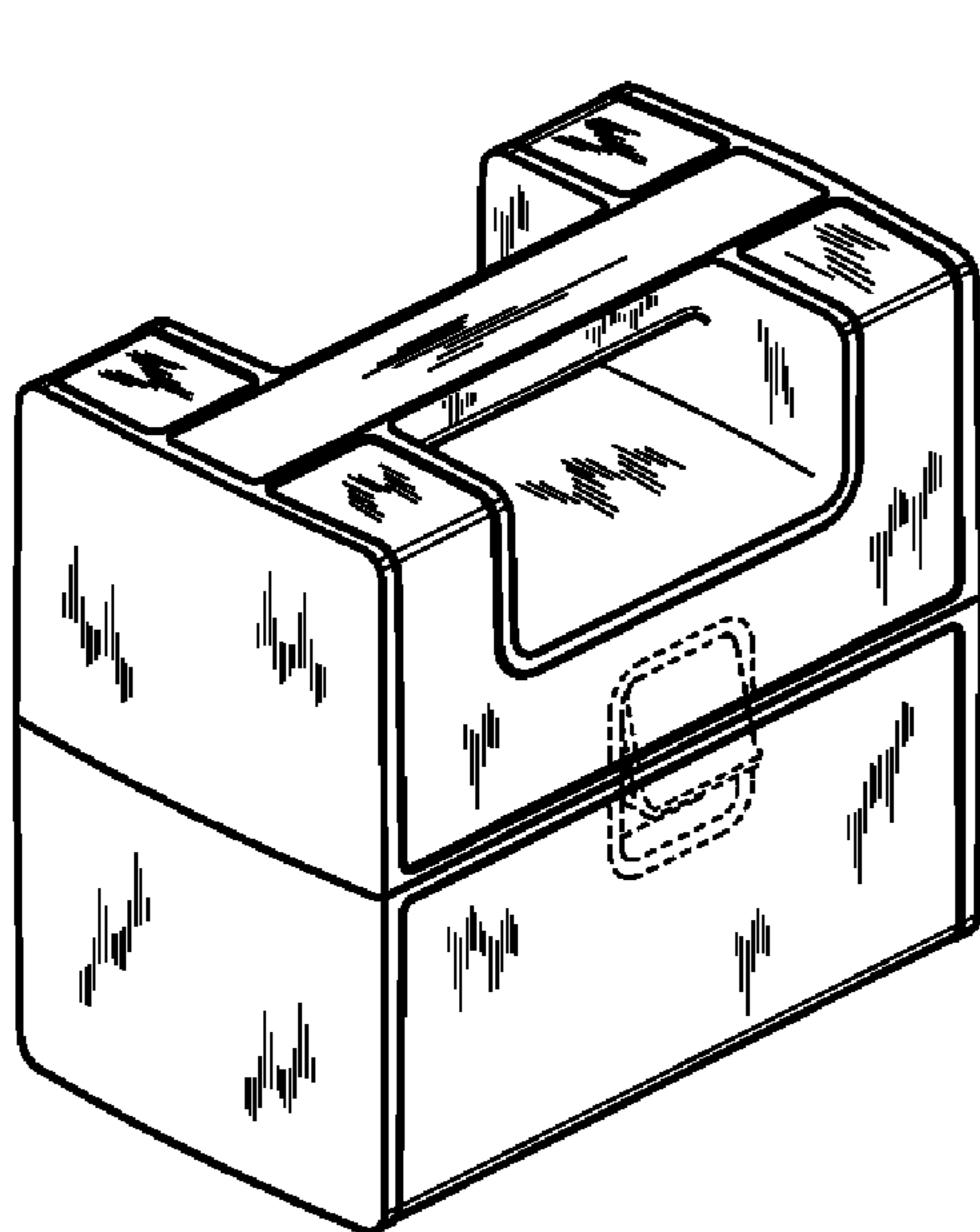

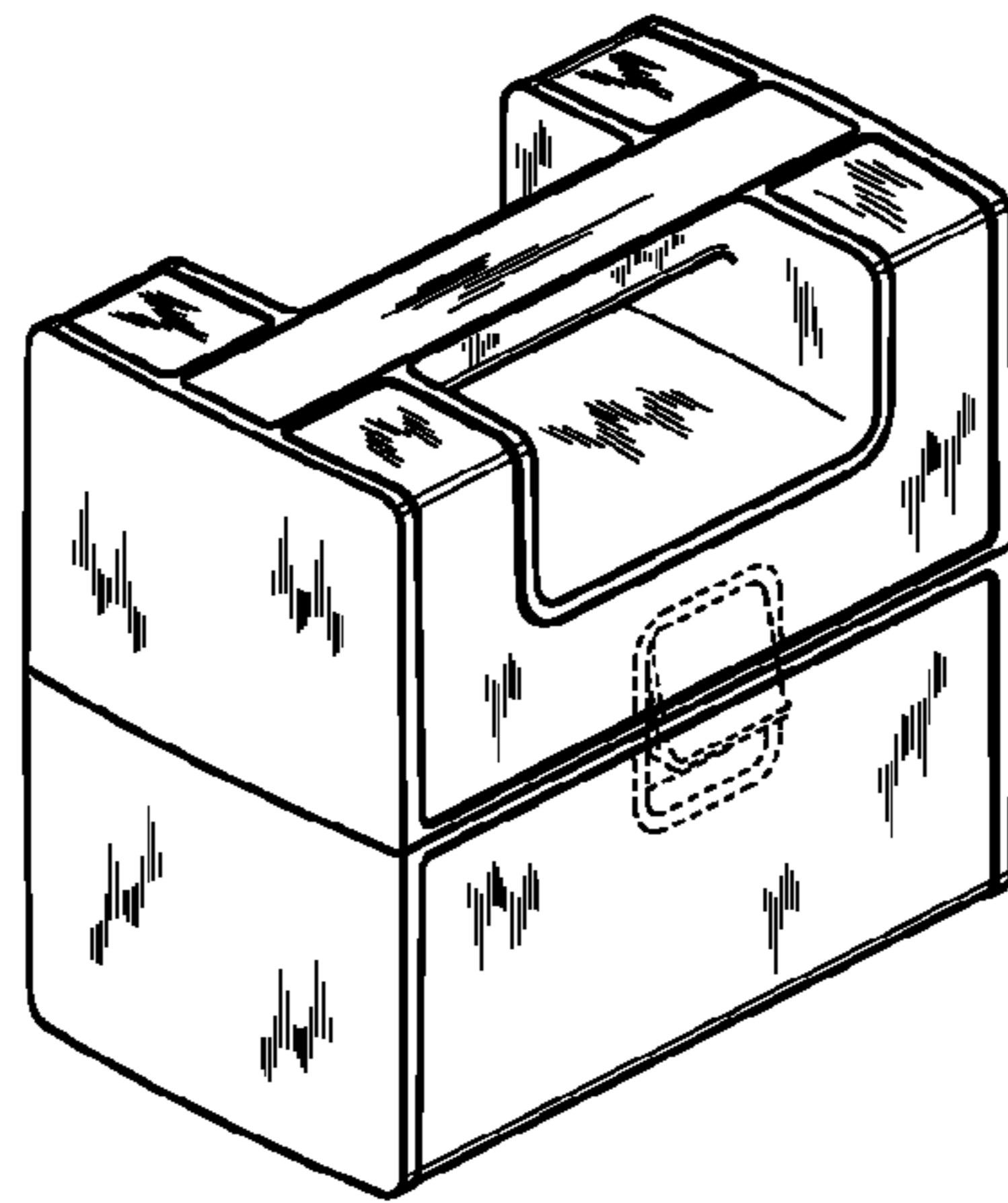

Figure 1

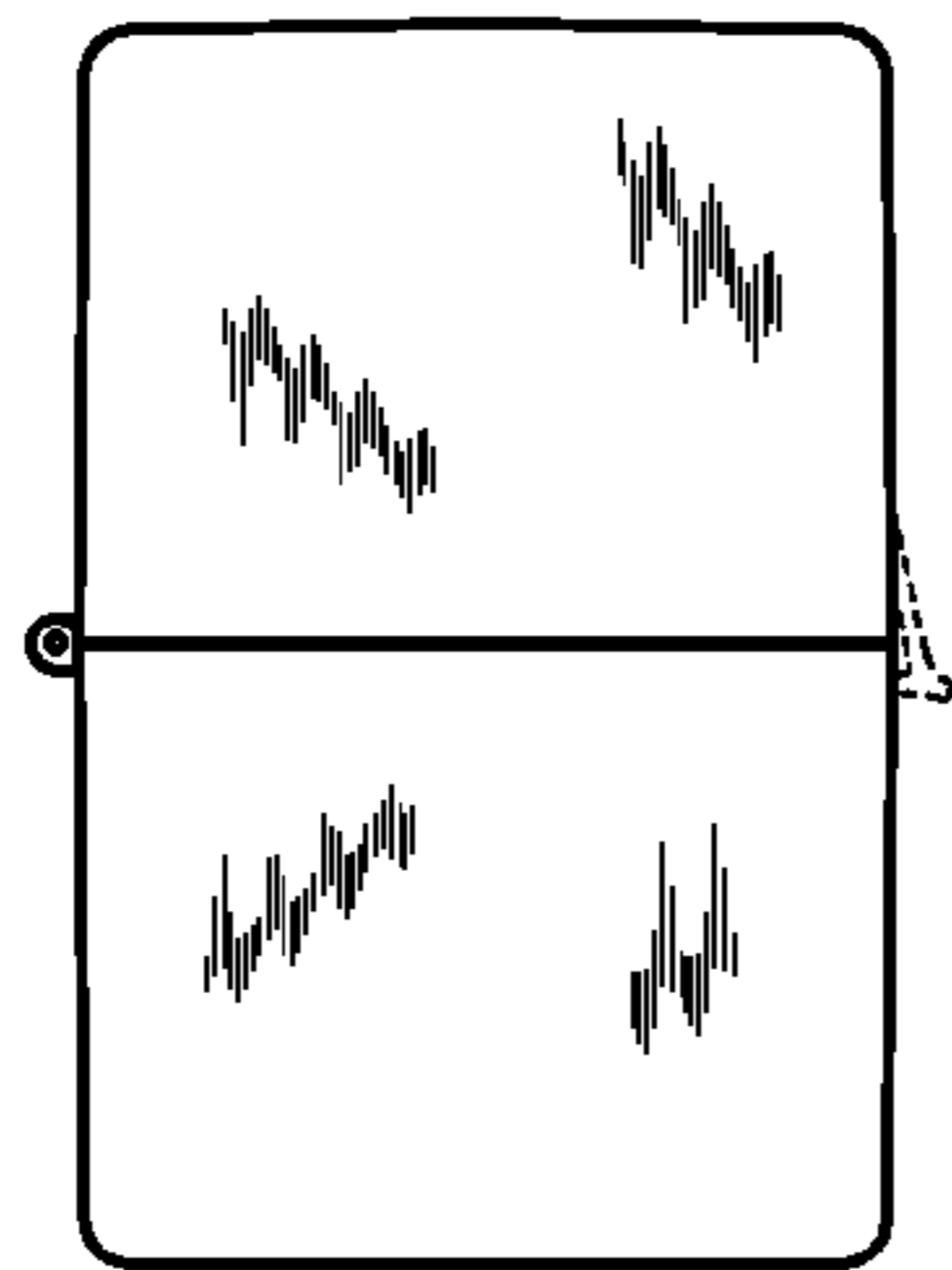

Figure 2

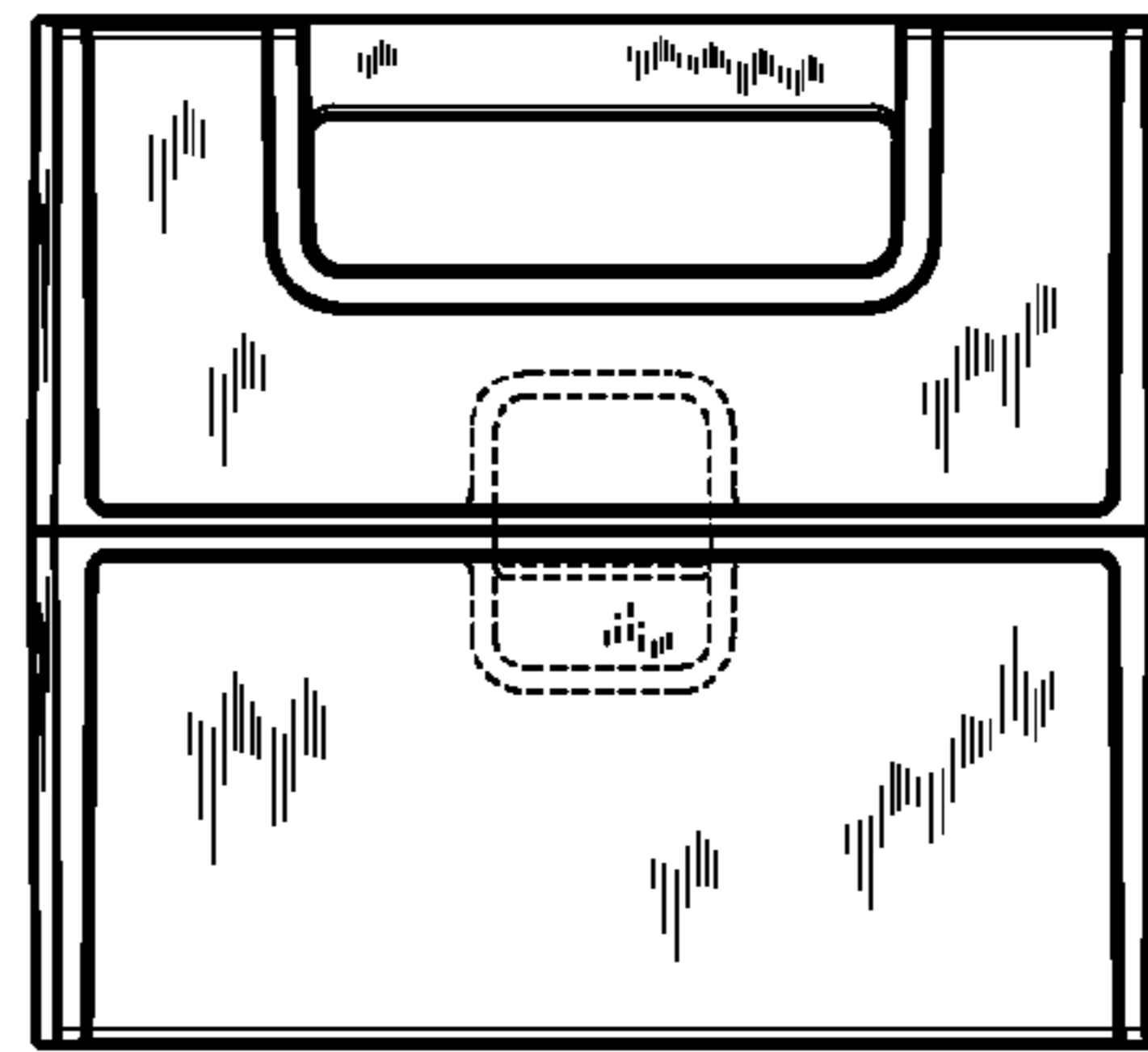

Figure 3

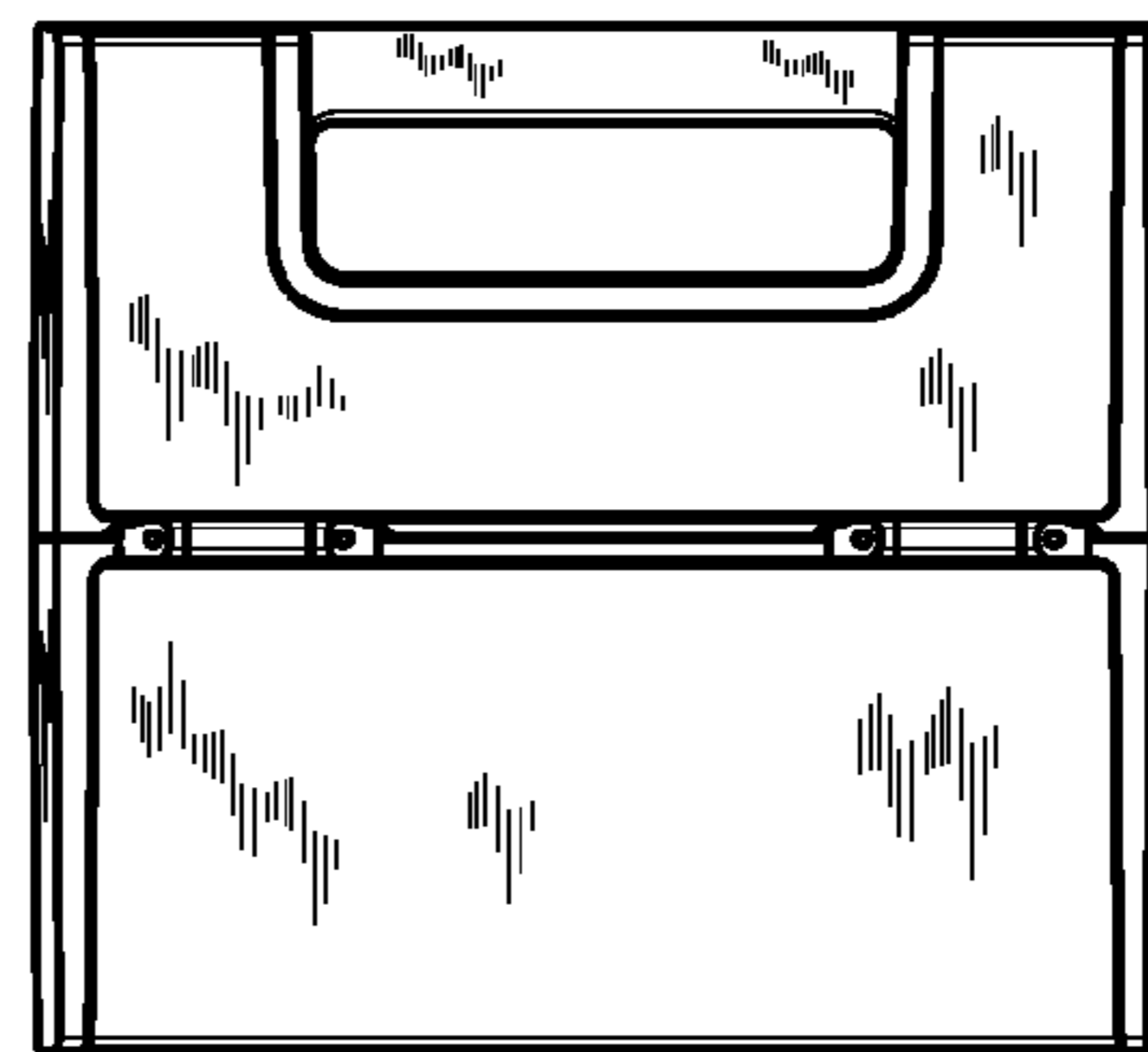

Figure 4

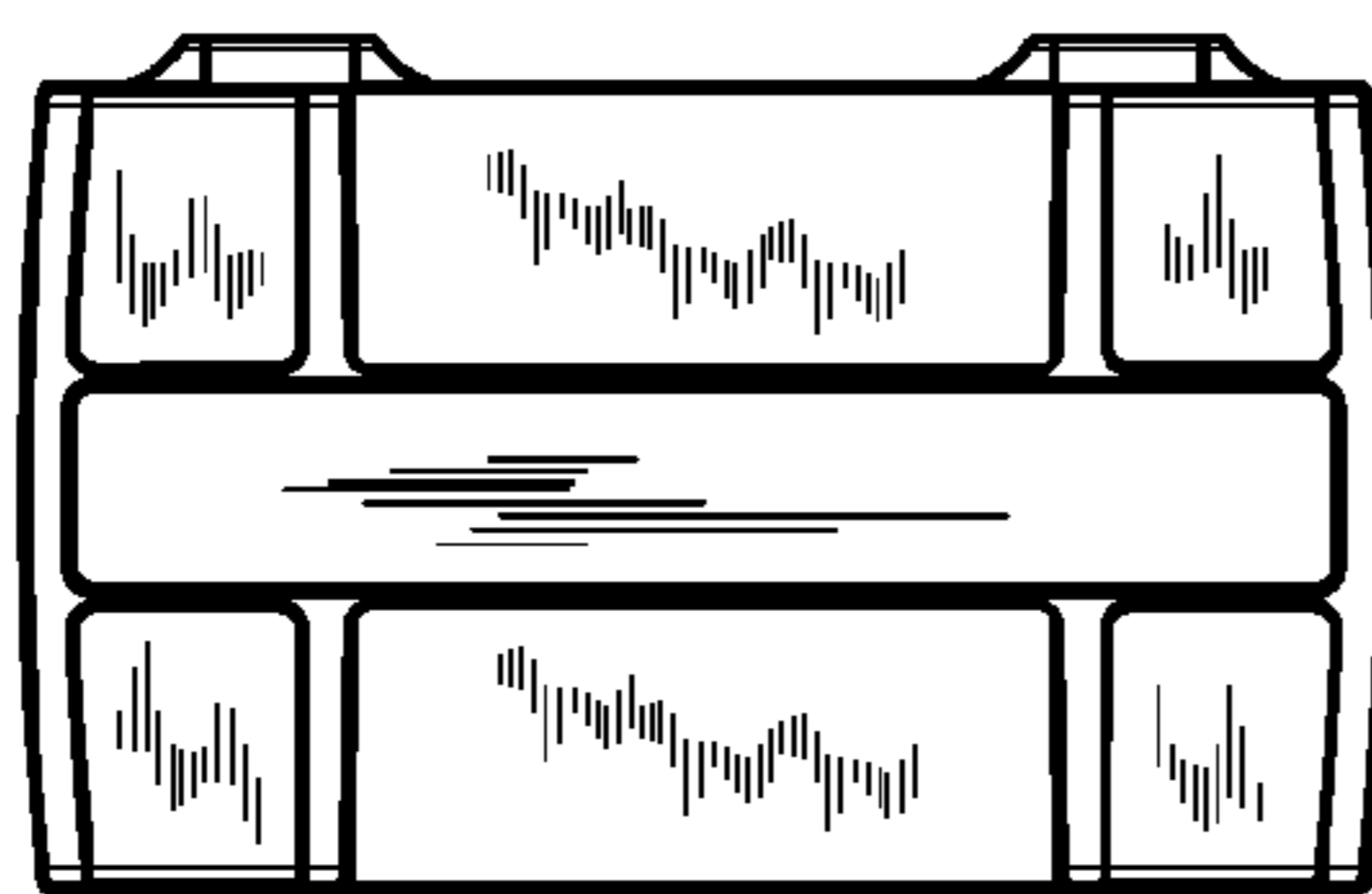

Figure 5

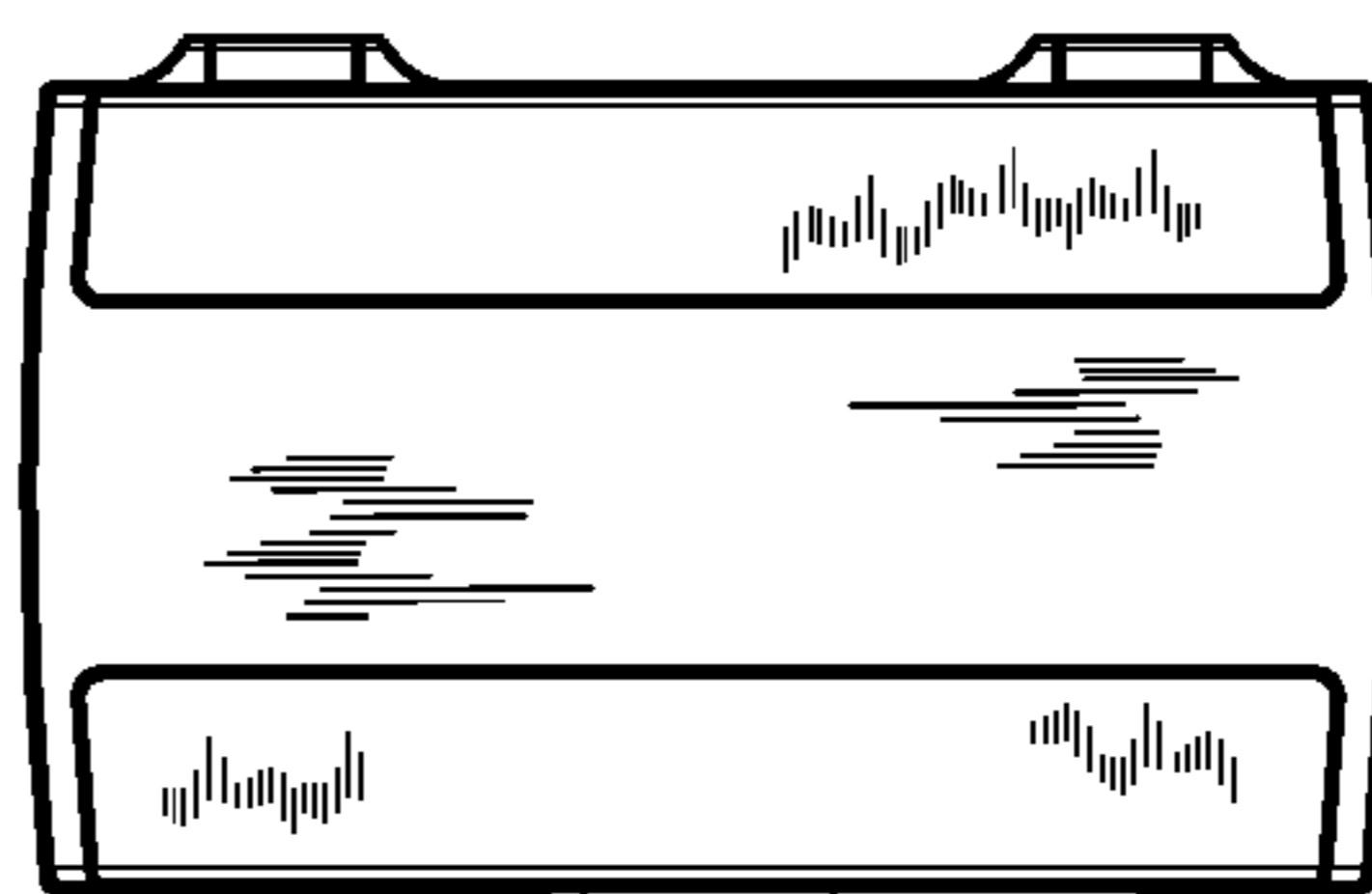

Figure 6

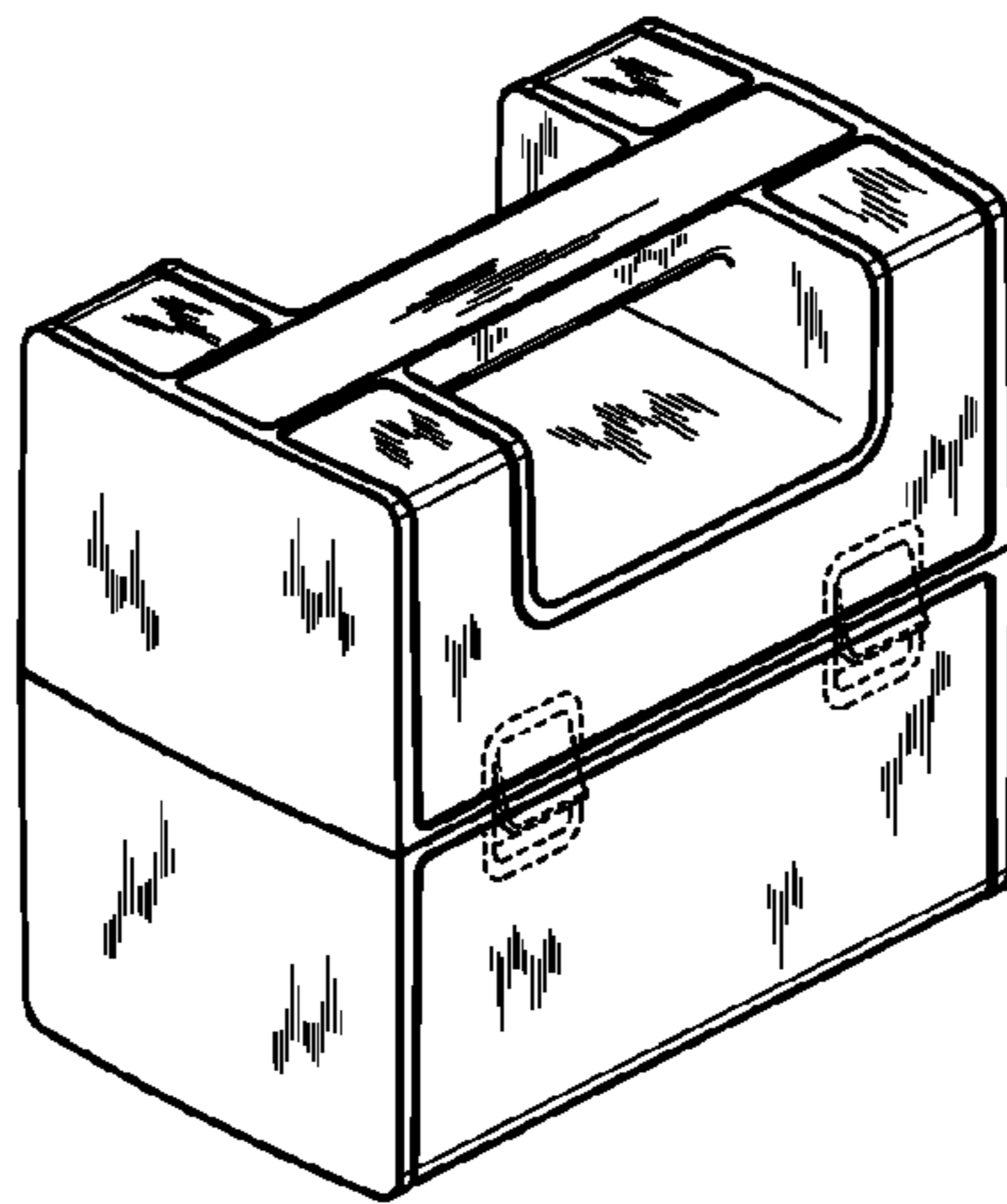

Figure 7

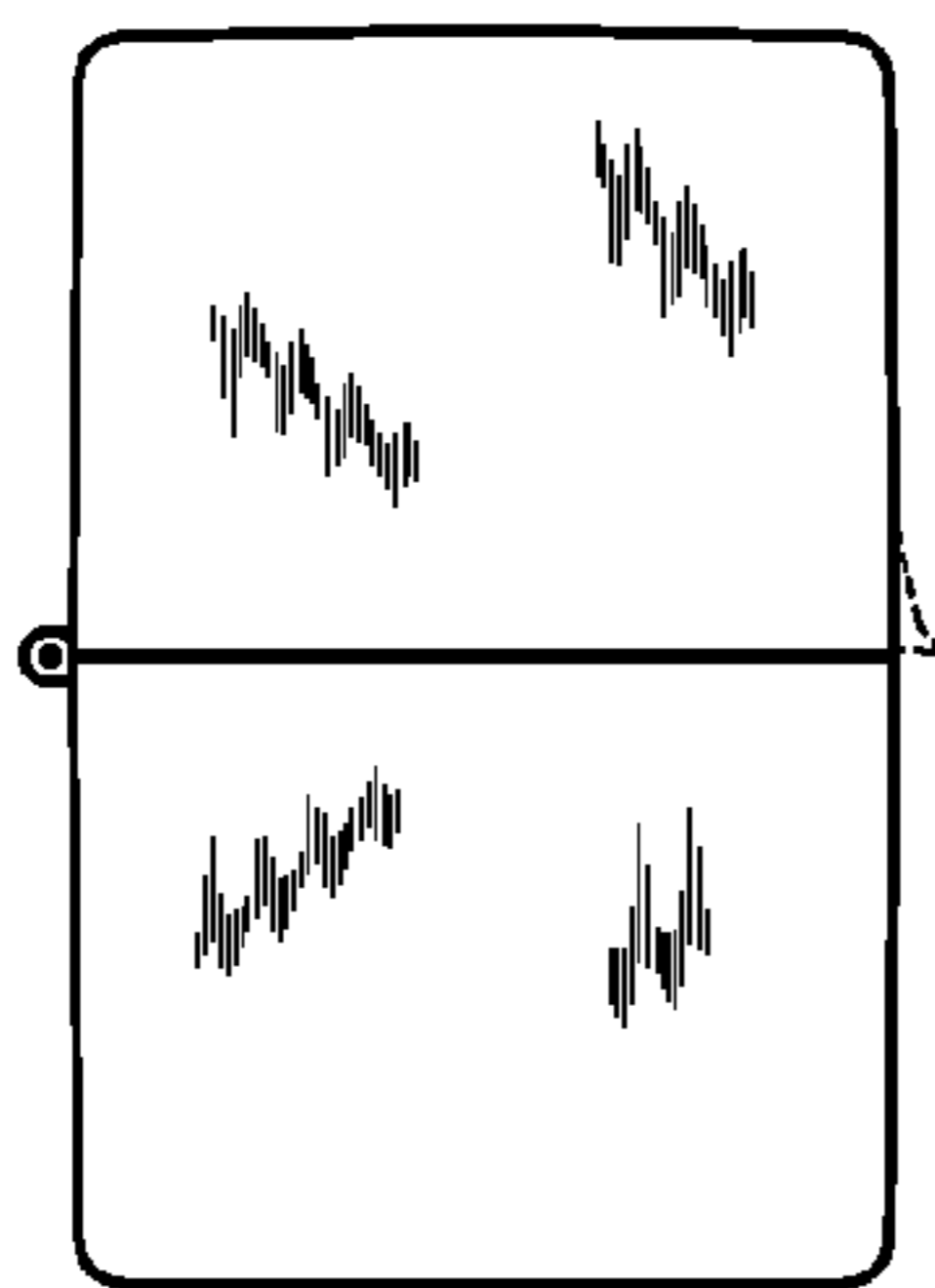

Figure 8

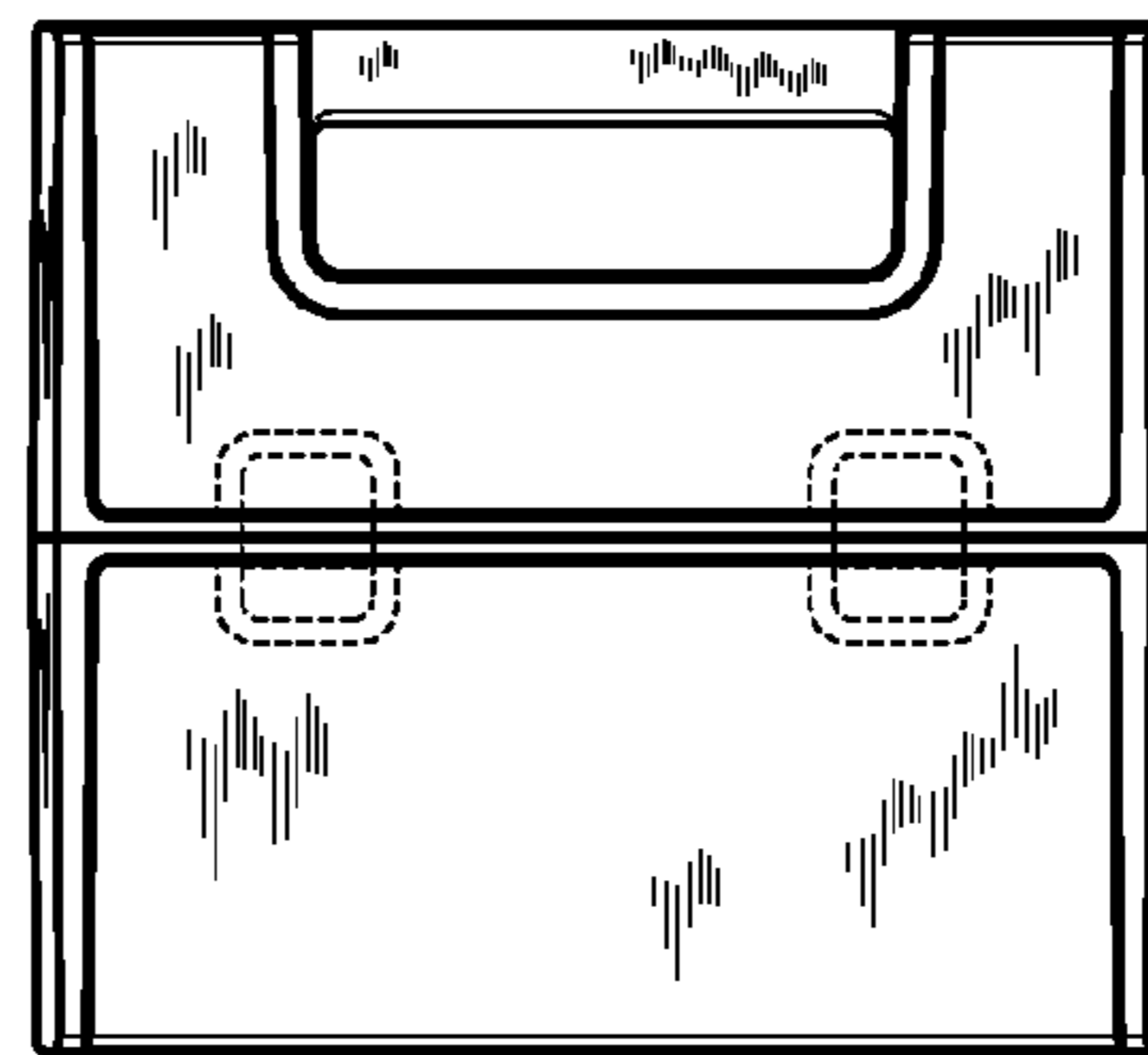

Figure 9

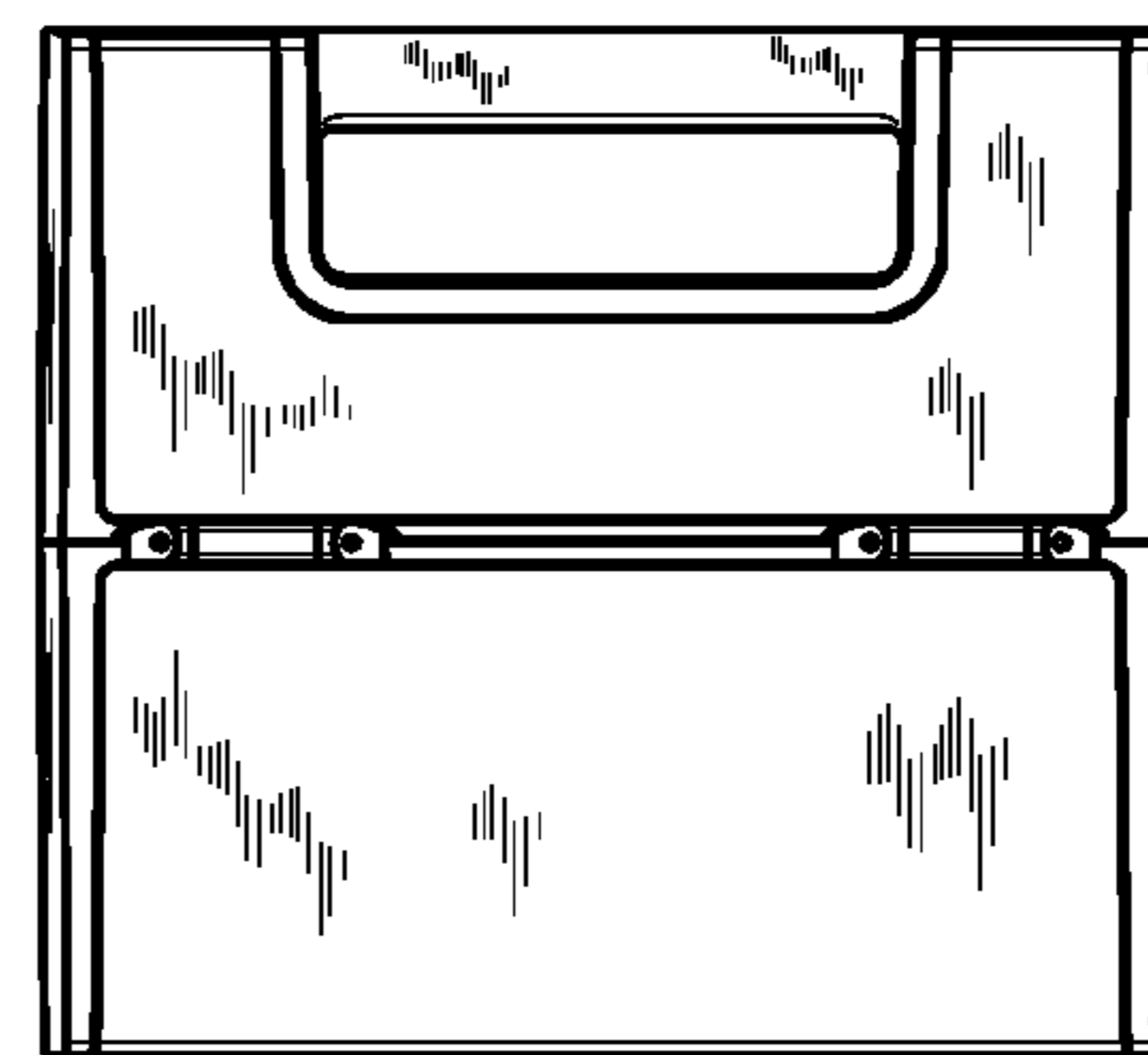

Figure 10

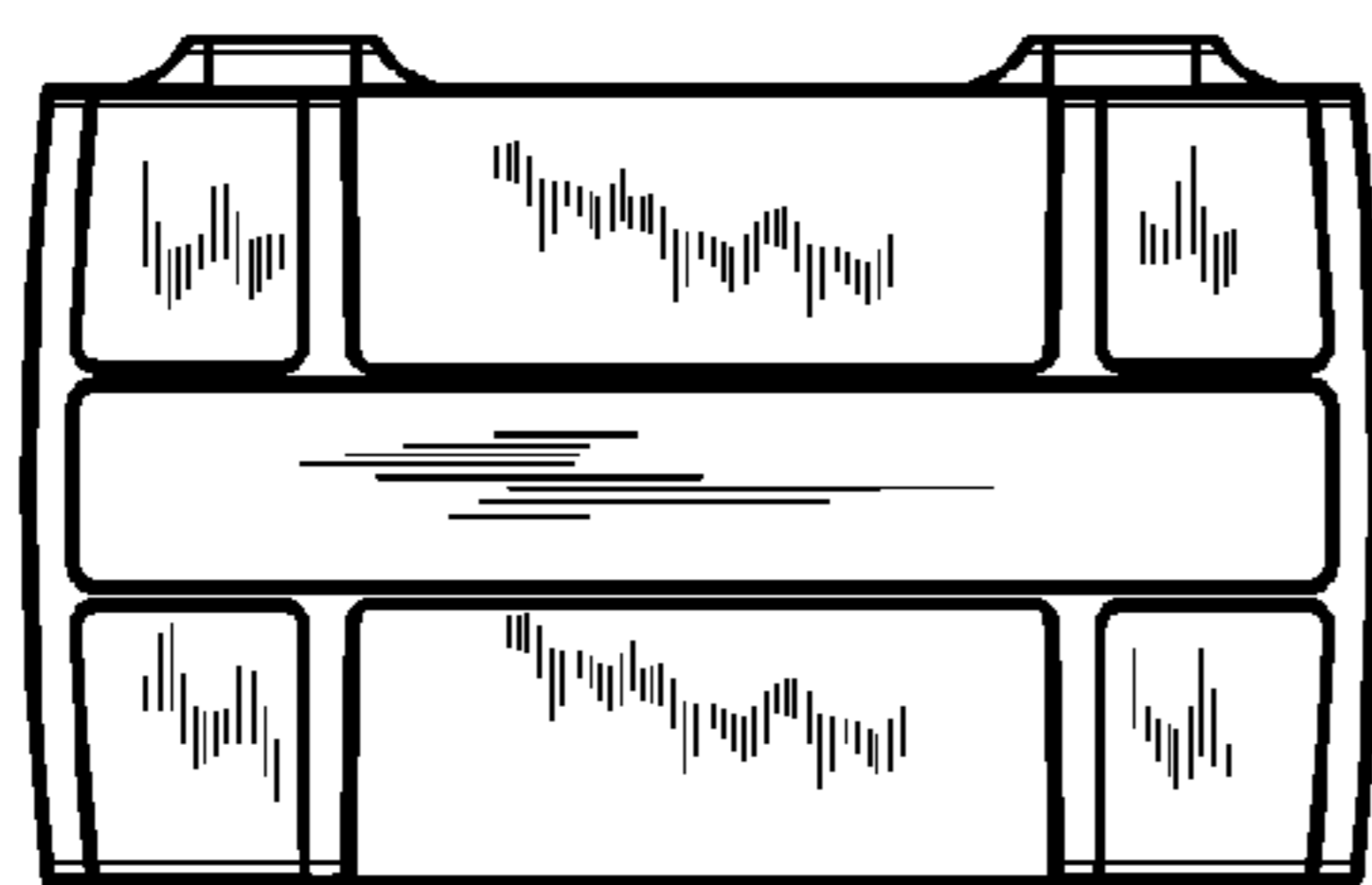

Figure 11

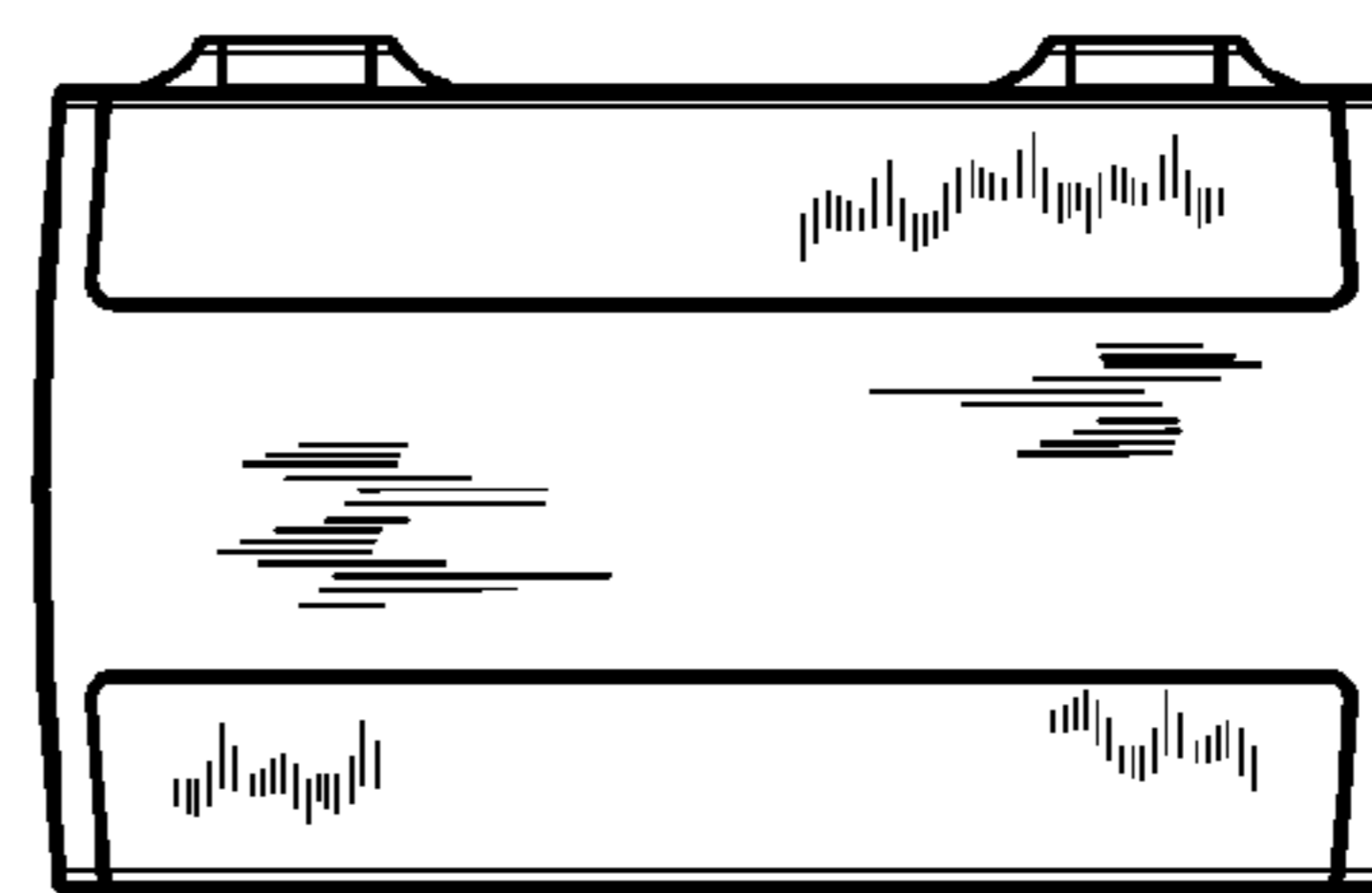

Figure 12

UNITED STATES PATENT AND TRADEMARK OFFICE
CERTIFICATE OF CORRECTION

PATENT NO. : Des. 587,453 S
APPLICATION NO. : 29/298980
DATED : March 3, 2009
INVENTOR(S) : Hans-Joerg Burkhard et al.

Page 1 of 1

It is certified that error appears in the above-identified patent and that said Letters Patent is hereby corrected as shown below:

On the title page, item (74) Attorney, Agent or Firm, please delete "Stanley Law Group LLP" and insert -- Standley Law Group LLP --.

On the title page, item (57) CLAIM, please delete "The ornamental design for a box for calibration weights, as shown and described." and insert -- The ornamental design for a storage box for calibration weights, as shown and described. --.

Signed and Sealed this

Third Day of November, 2009

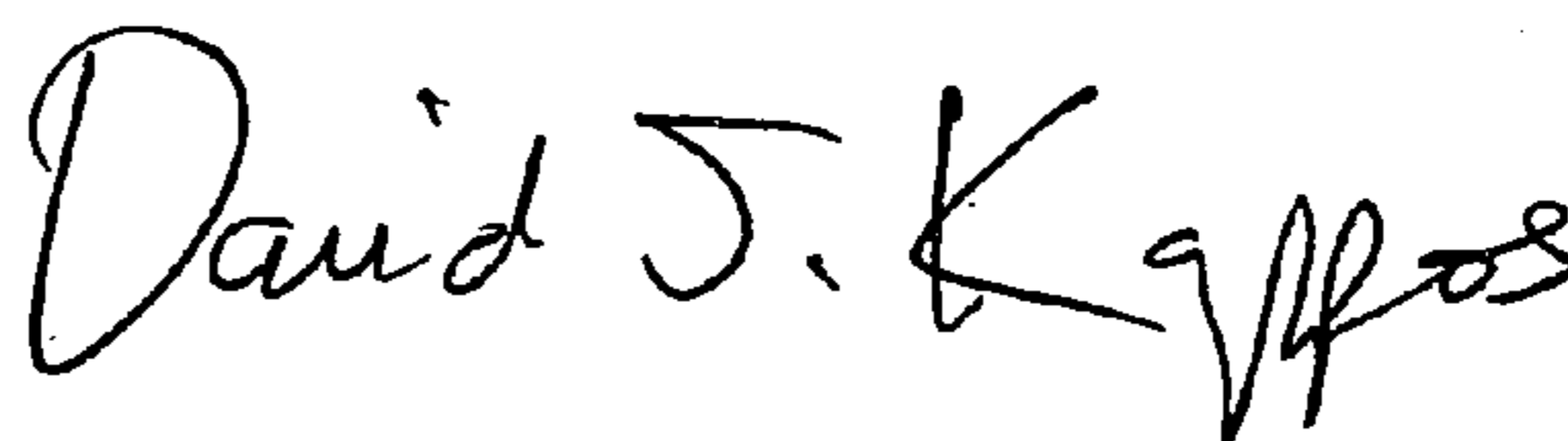

David J. Kappos
Director of the United States Patent and Trademark Office