



US00D587286S

(12) **United States Design Patent**
Jurasz et al.

(10) **Patent No.:** **US D587,286 S**
(45) **Date of Patent:** **** Feb. 24, 2009**

(54) **HOUSING FOR A DISPLAY PANEL OF A ROAD CONSTRUCTION MACHINE**

DESCRIPTION

(75) Inventors: **Jaroslav Jurasz**, Windhagen (DE);
Günter Hähn, Königswinter (DE)

(73) Assignee: **Wirtgen GmbH** (DE)

(**) Term: **14 Years**

(21) Appl. No.: **29/287,772**

(22) Filed: **Sep. 18, 2007**

(30) **Foreign Application Priority Data**

Mar. 23, 2007 (EM) 000695028

(51) **LOC (9) Cl.** **15-03**

(52) **U.S. Cl.** **D15/28**

(58) **Field of Classification Search** D15/28;
D13/184, 162, 164; D14/247, 285, 415;
D12/192; D10/125; D34/28, 35; 180/315;
212/324, 326, 327; 220/811; 414/273, 495,
414/454, 459, 460

See application file for complete search history.

(56) **References Cited**

U.S. PATENT DOCUMENTS

D287,360 S * 12/1986 Lehmann D13/184

(Continued)

Primary Examiner—Stella M Reid

Assistant Examiner—Mark A Goodwin

(74) *Attorney, Agent, or Firm*—Miles & Stockbridge P.C.;
Vincent L. Ramik, Esq.

(57) **CLAIM**

The ornamental design for a housing for a display panel of a road construction machine, as shown and described.

FIG. 1 is a top perspective view of a top cover of a housing for a display panel of a road construction machine showing my new design, the top cover shown removed for ease of illustration,

FIG. 2 is a top plan view,

FIG. 3 is a bottom plan view,

FIG. 4 is a front elevational view of FIG. 2,

FIG. 5 is a rear elevational view of FIG. 3,

FIG. 6 is a side elevational view of FIG. 3,

FIG. 7 is an opposite side elevational view of FIG. 3,

FIG. 8 is a top perspective view of a bottom part of a housing for a display panel of a road construction machine showing my new design, the bottom part shown removed for ease of illustration,

FIG. 9 is a top plan view of FIG. 8,

FIG. 10 is a bottom plan view of FIG. 8,

FIG. 11 is a side elevational view of FIG. 10,

FIG. 12 is an opposite side elevational view of FIG. 10,

FIG. 13 is a bottom elevational view of FIG. 10,

FIG. 14 is a top elevational view of FIG. 10.,

FIG. 15 is a top perspective view of a housing for a display panel of a road construction machine showing my new design, the top cover and bottom part shown in assembled condition,

FIG. 16 is a top plan view of FIG. 15,

FIG. 17 is a bottom plan view of FIG. 15,

FIG. 18 is a bottom elevational view of FIG. 17,

FIG. 19 is a top elevational view of FIG. 17,

FIG. 20 is a side elevational view of FIG. 17; and,

FIG. 21 is an opposite side elevational view of FIG. 17.

1 Claim, 21 Drawing Sheets

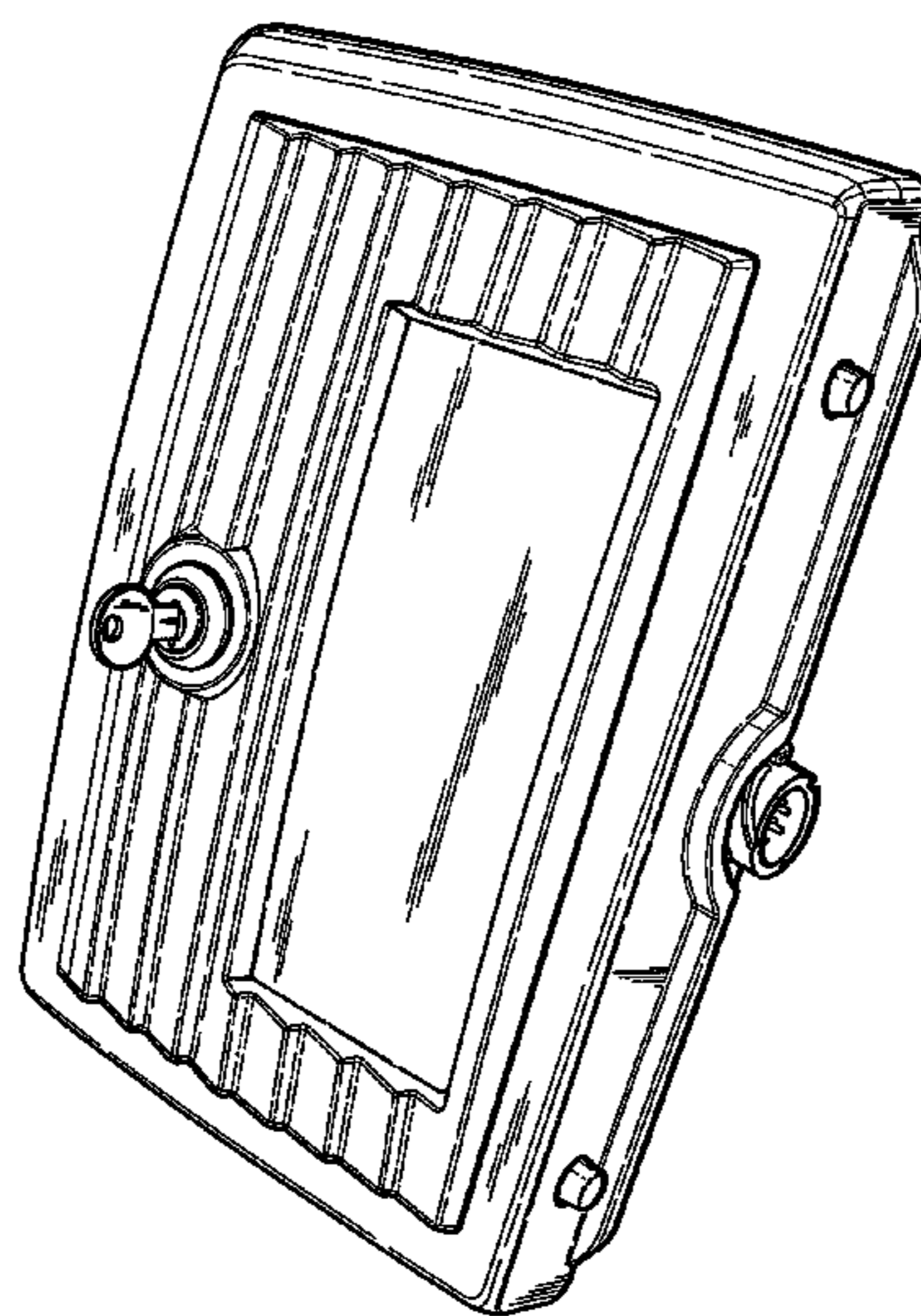

US D587,286 S

Page 2

U.S. PATENT DOCUMENTS

D311,520 S	*	10/1990	Serio, Jr.	D13/184	D513,497 S	*	1/2006	Whitehouse	D13/162
D359,947 S	*	7/1995	Greene	D13/158	D518,451 S	*	4/2006	Nussberger et al.	D13/184
D380,199 S	*	6/1997	Beruscha et al.	D13/184	D532,427 S	*	11/2006	Kim	D15/28
D404,391 S	*	1/1999	Herbstritt et al.	D13/162	D542,745 S	*	5/2007	Barnes et al.	D13/184
D456,364 S	*	4/2002	Suen	D13/162	D550,167 S	*	9/2007	Popa	D13/164
D462,063 S	*	8/2002	Bohne	D14/125	D558,685 S	*	1/2008	Peterson	D13/162
D485,810 S	*	1/2004	Fiocchi	D13/184	D561,114 S	*	2/2008	Peterson	D13/162
D492,264 S	*	6/2004	Perez et al.	D13/162	D564,972 S	*	3/2008	Peterson	D13/162
D505,239 S	*	5/2005	Green et al.	D34/35	D567,776 S	*	4/2008	Wells	D13/184
D511,150 S	*	11/2005	Nurmi et al.	D13/184	2006/0243270 A1	*	11/2006	Moskwa et al.	126/194

* cited by examiner

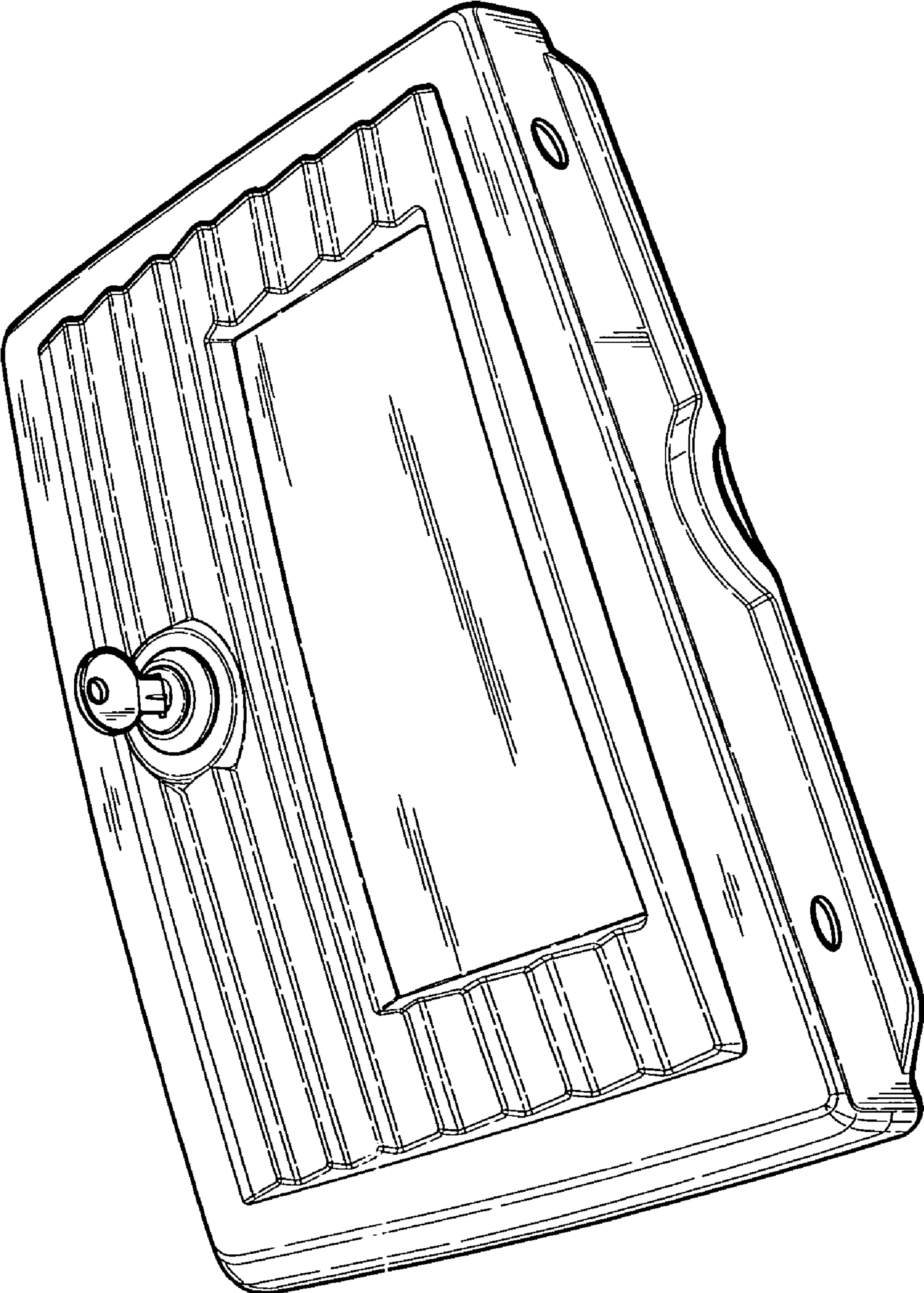

FIGURE 1



FIGURE 2

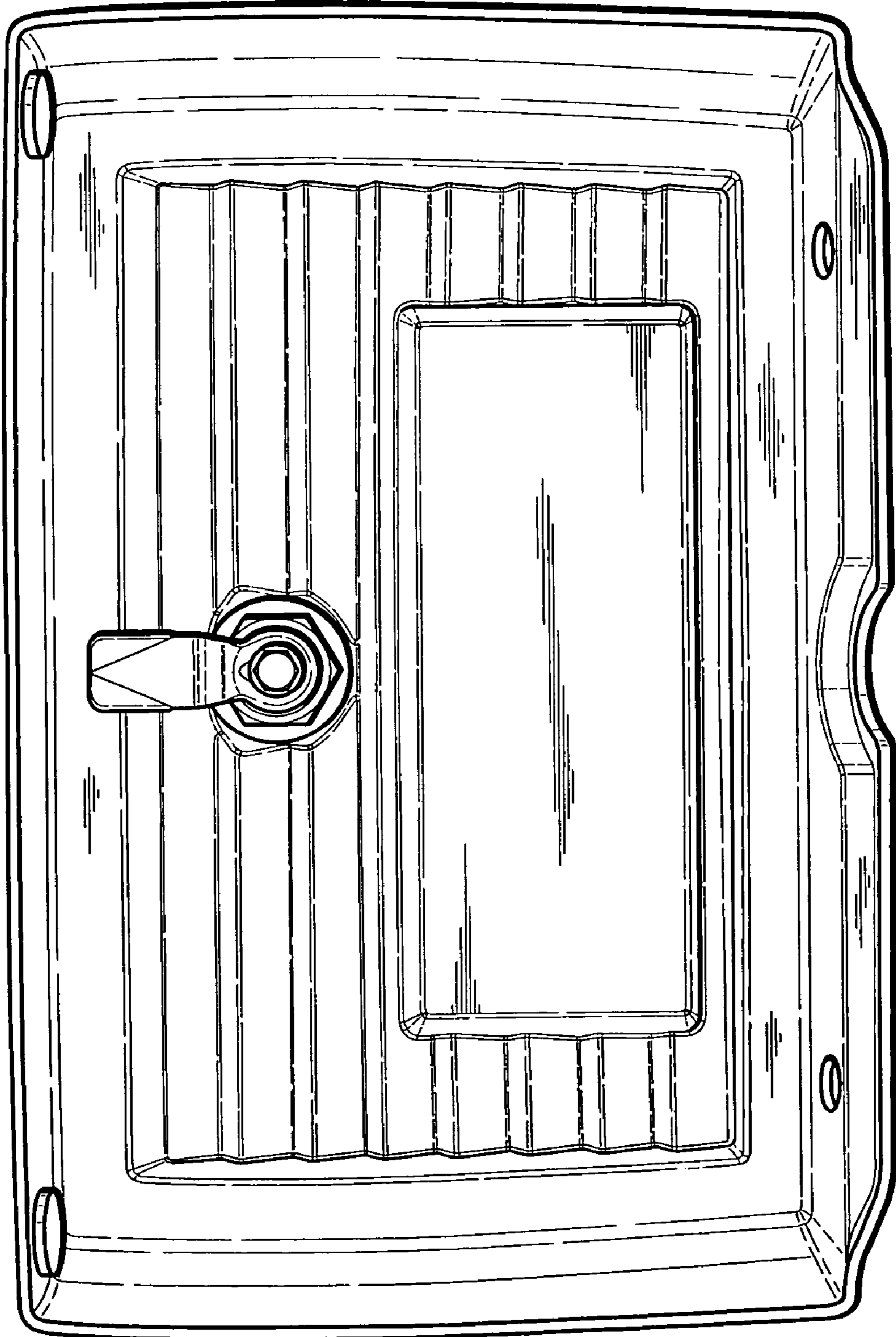

FIGURE 3

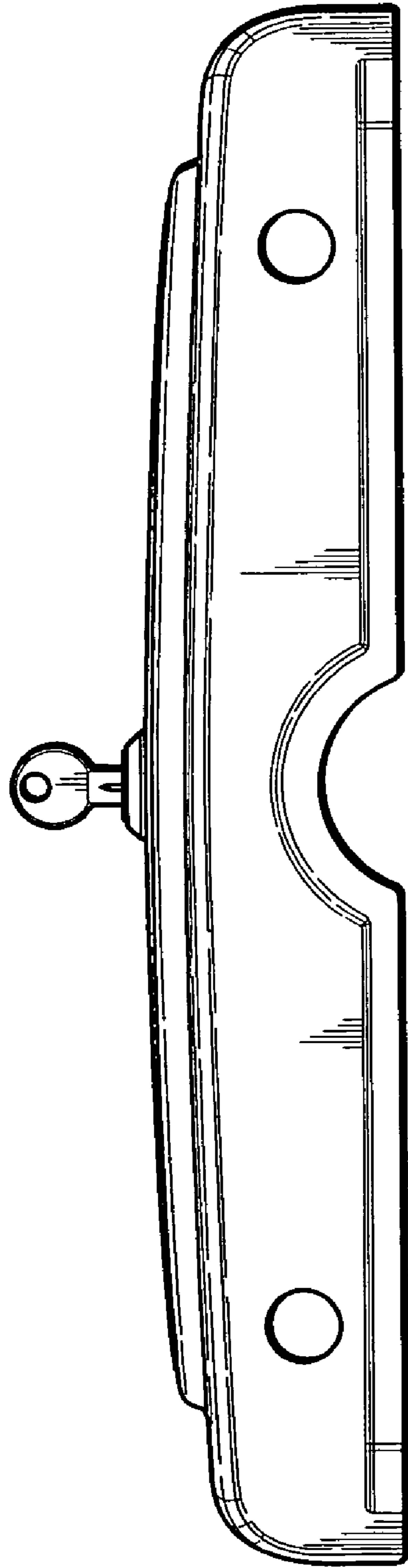

FIGURE 4

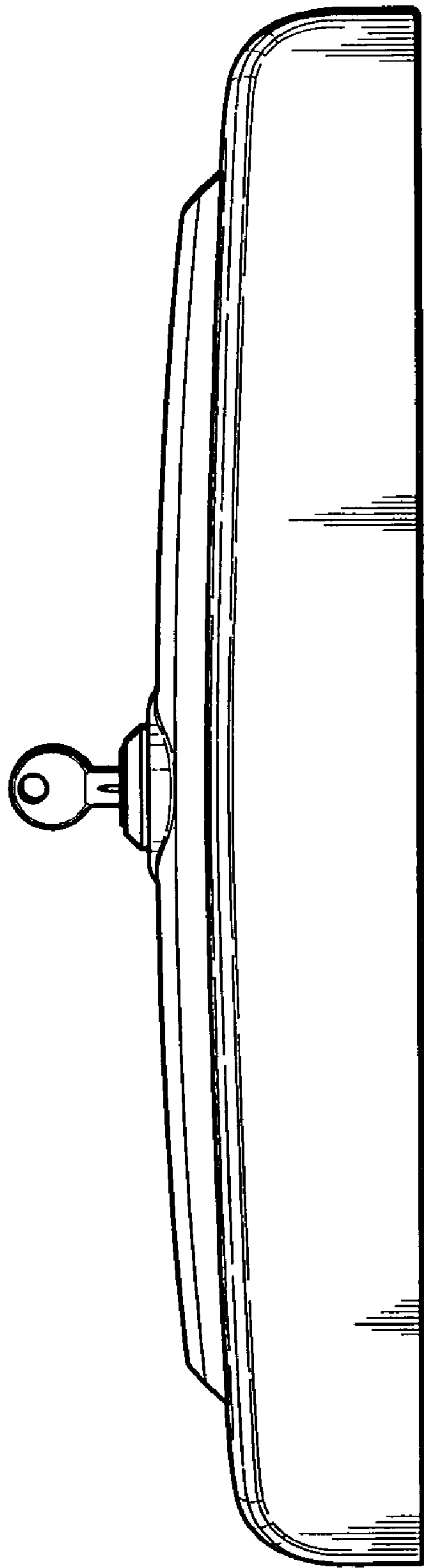

FIGURE 5

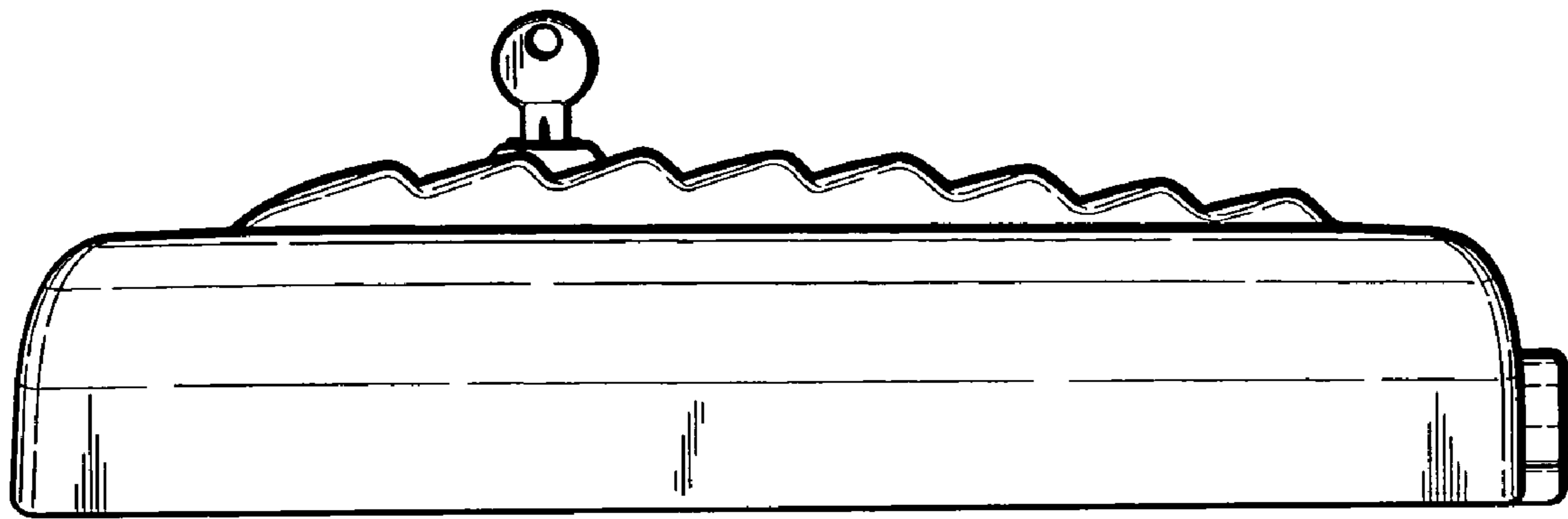

FIGURE 6

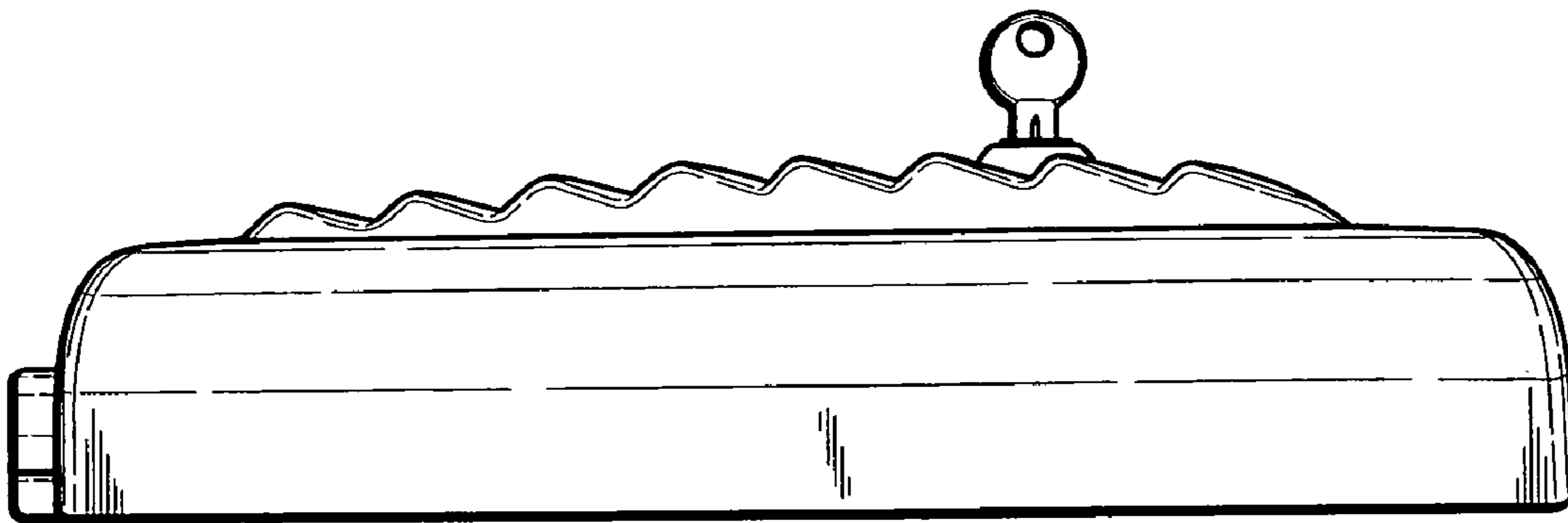

FIGURE 7

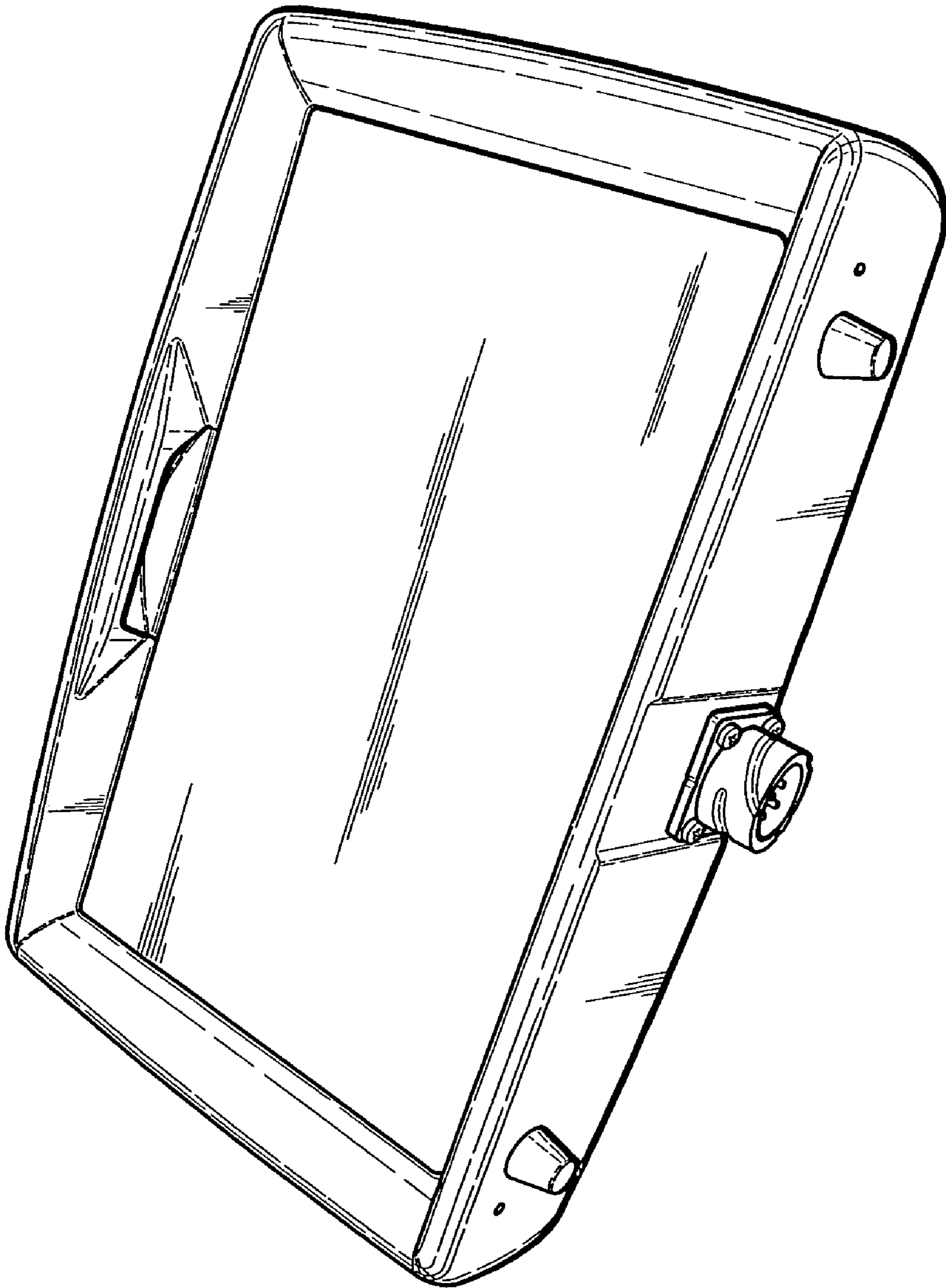

FIGURE 8



FIGURE 9

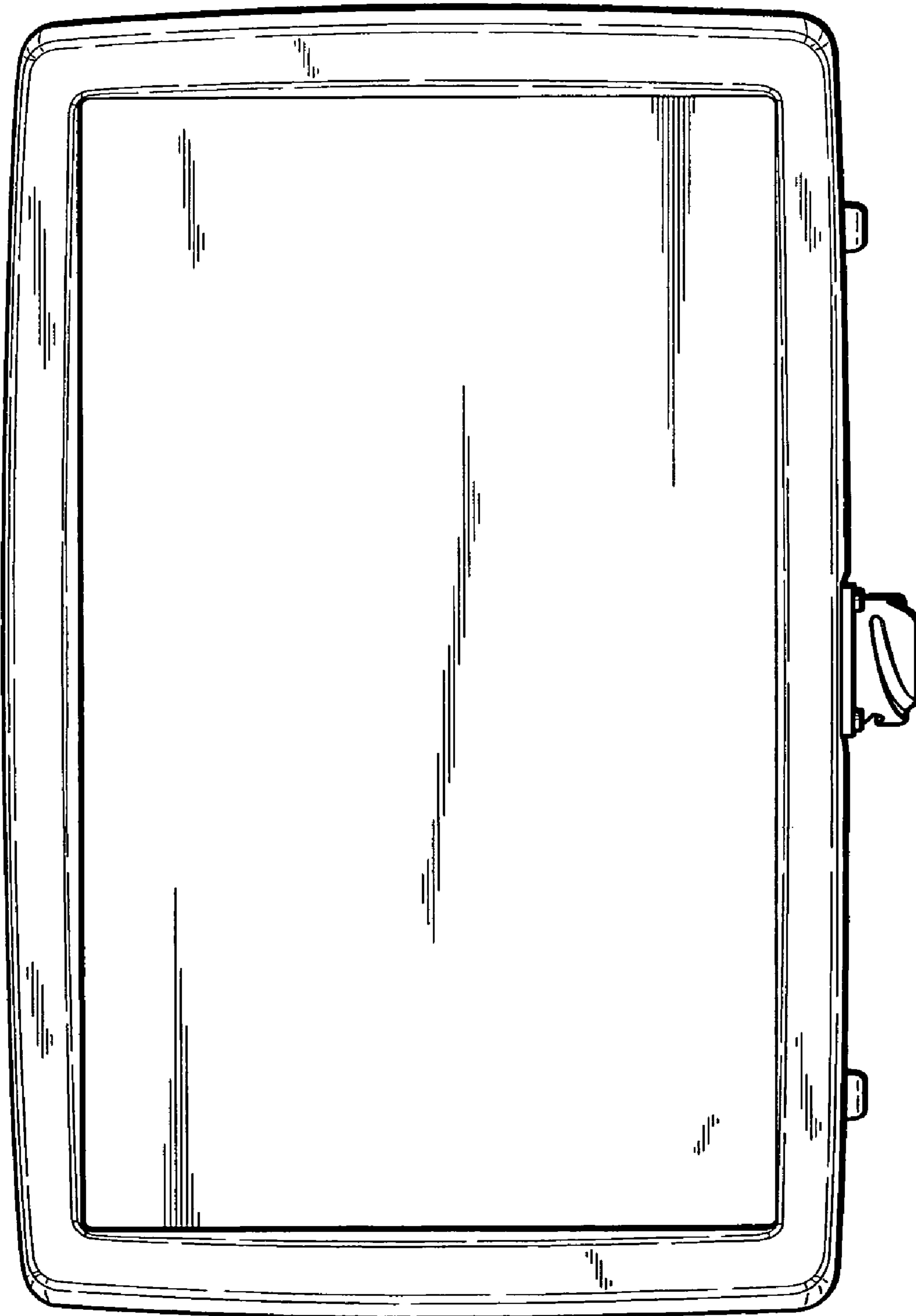

FIGURE 10

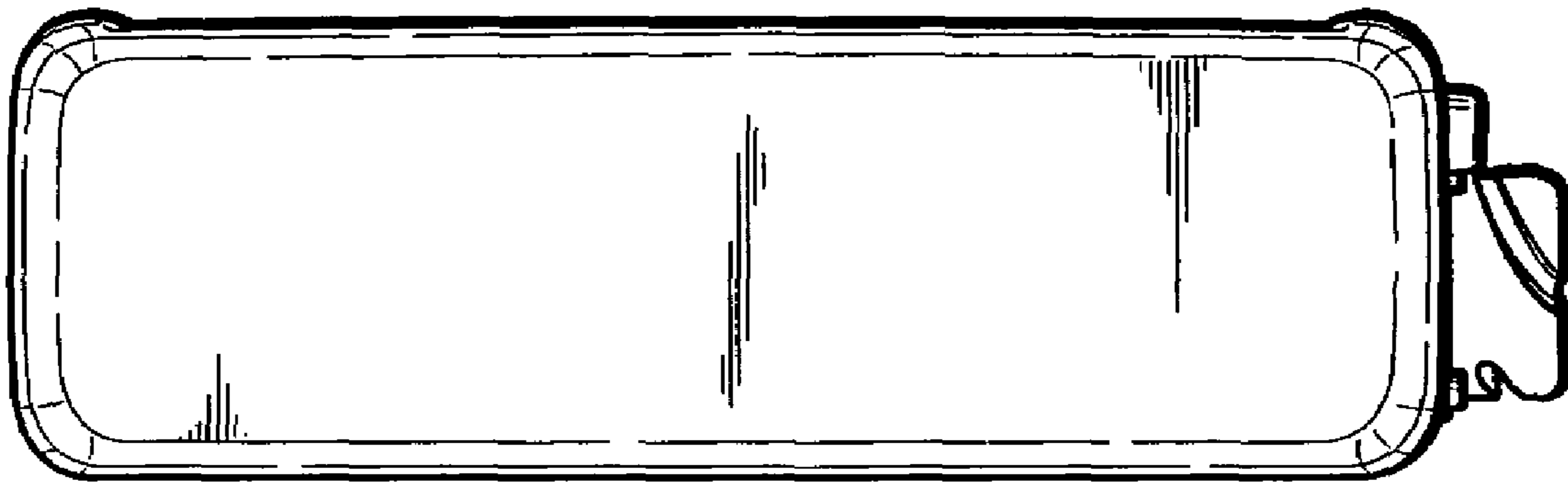

FIGURE 11

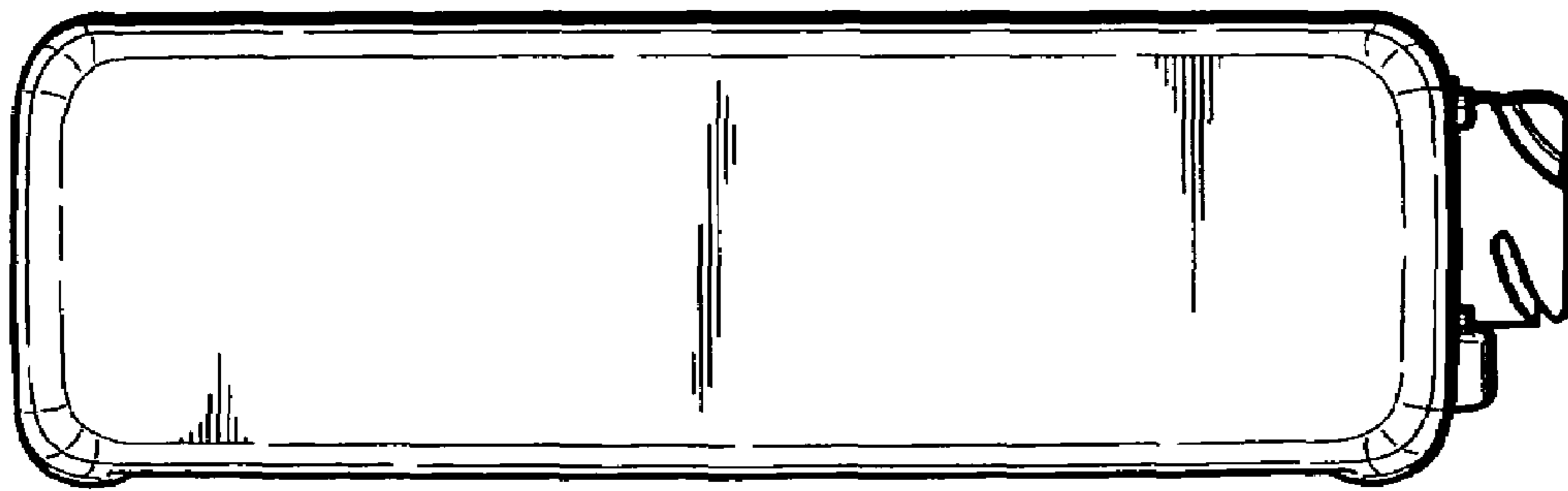

FIGURE 12

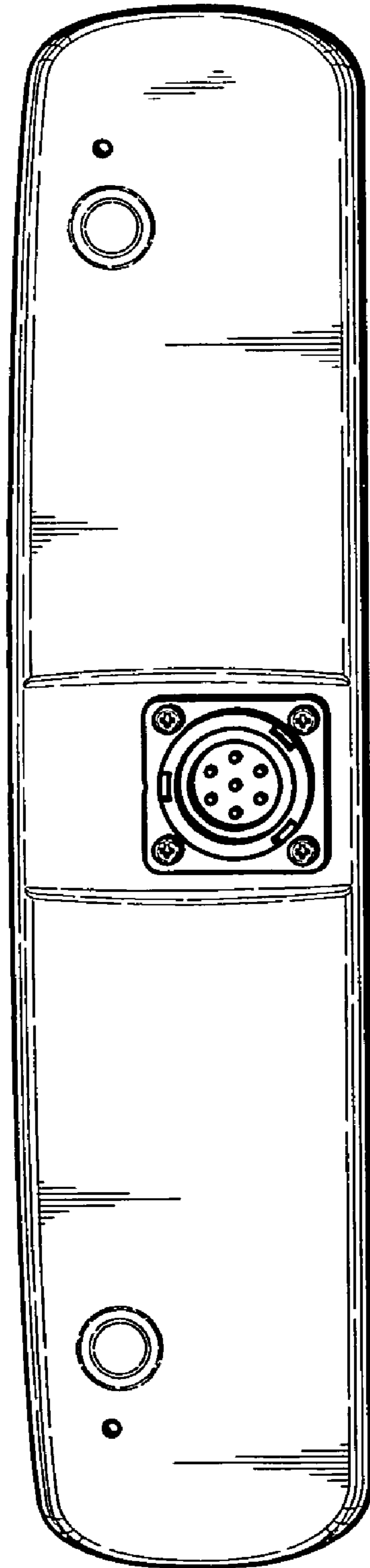

FIGURE 13

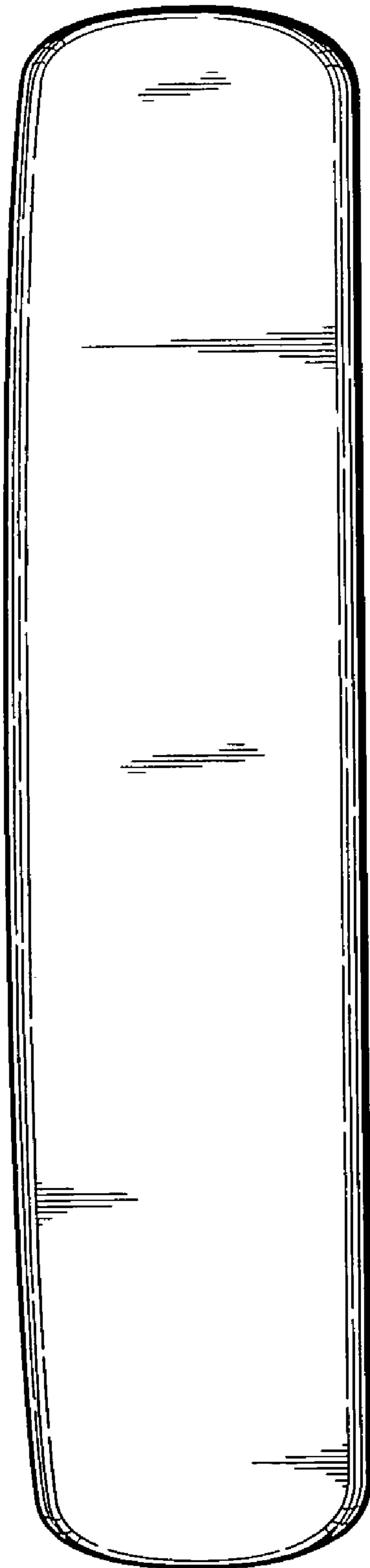

FIGURE 14

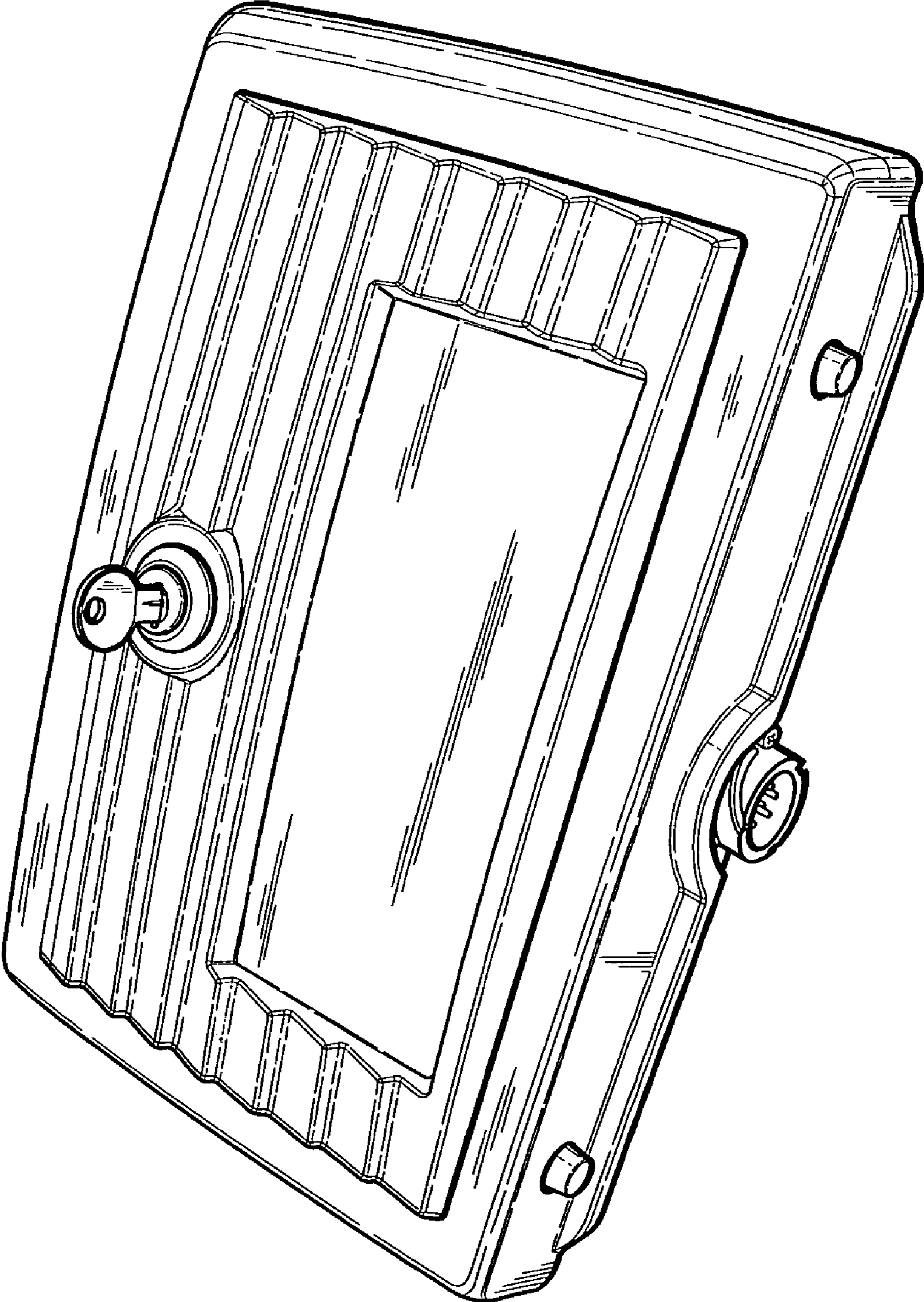

FIGURE 15

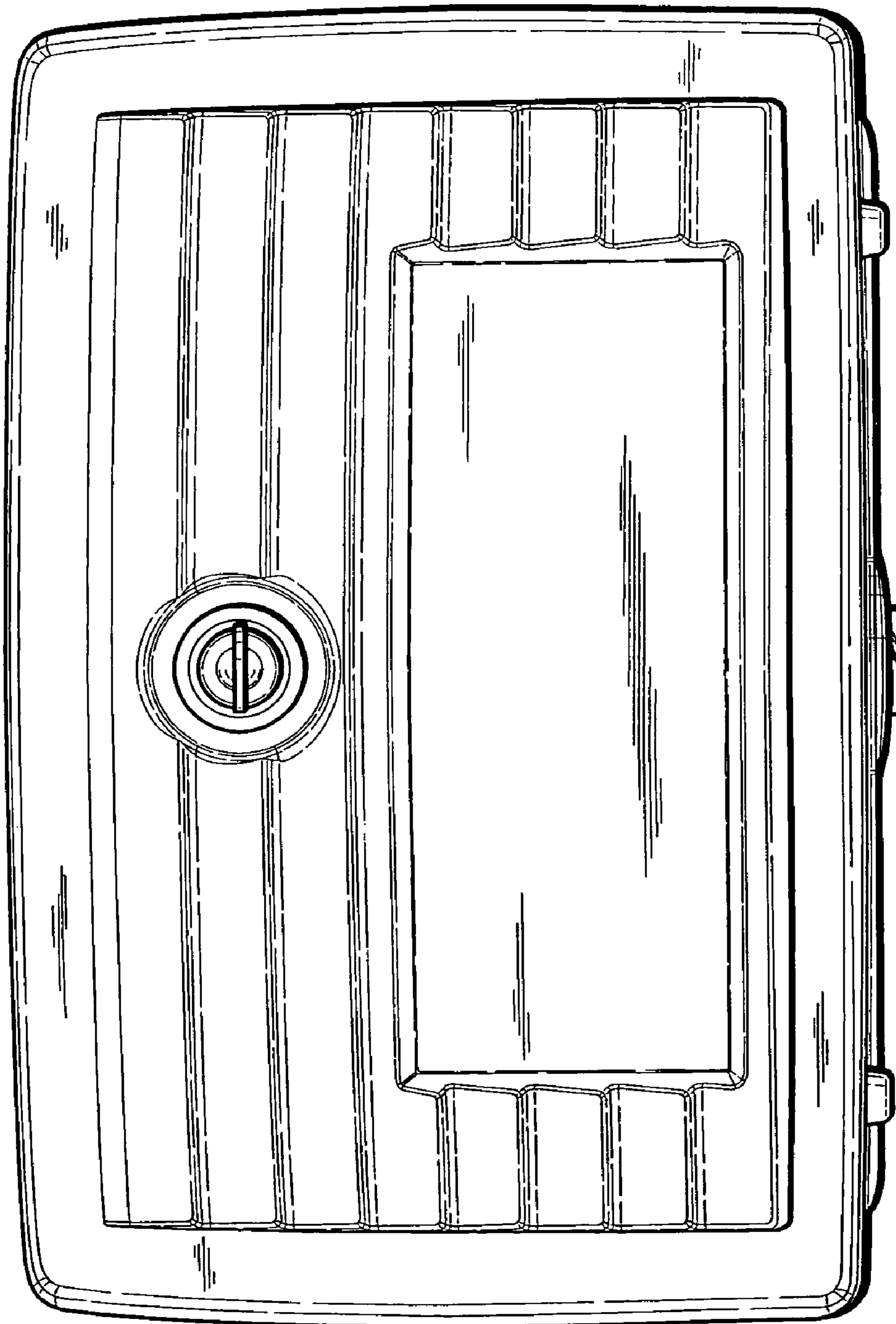

FIGURE 16

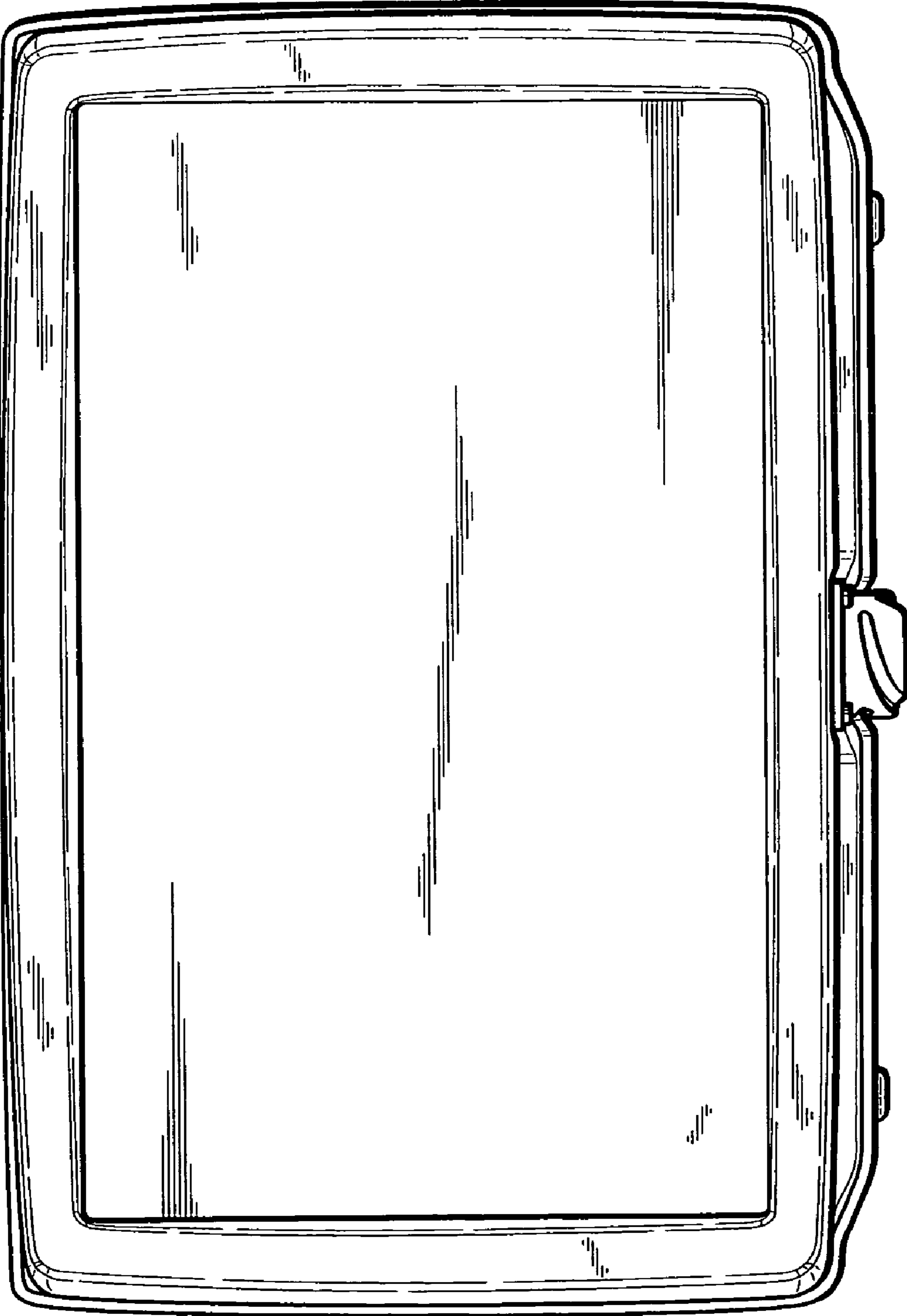

FIGURE 17

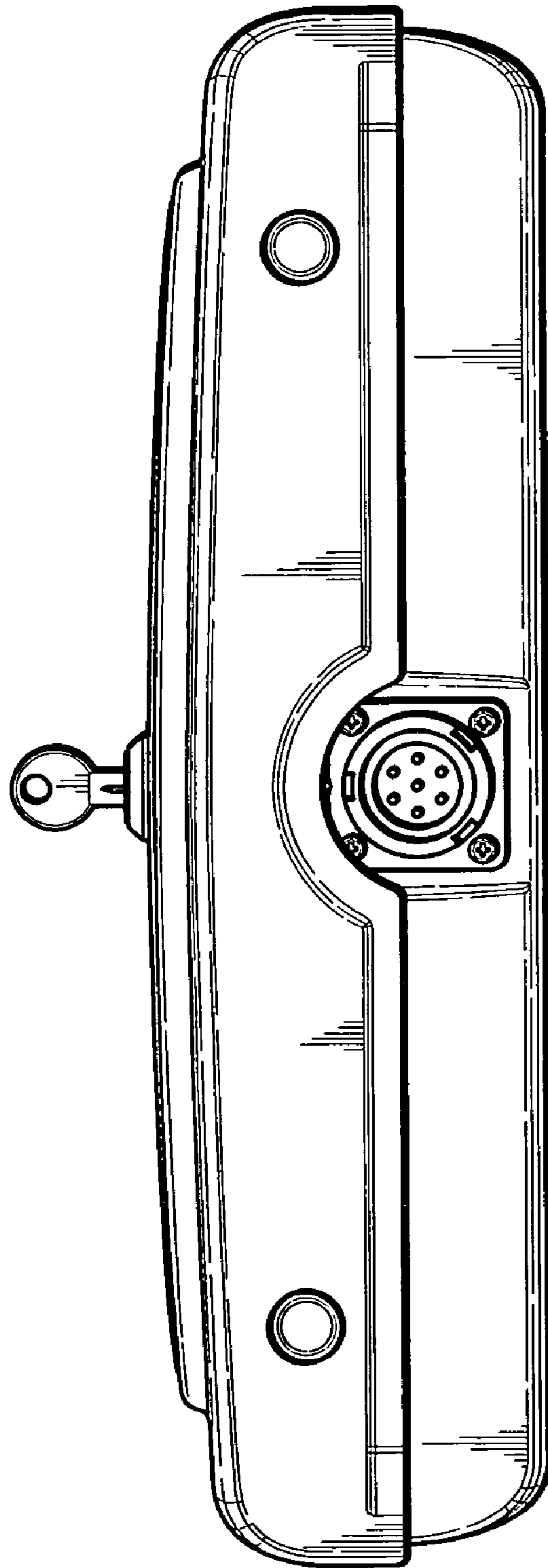

FIGURE 18

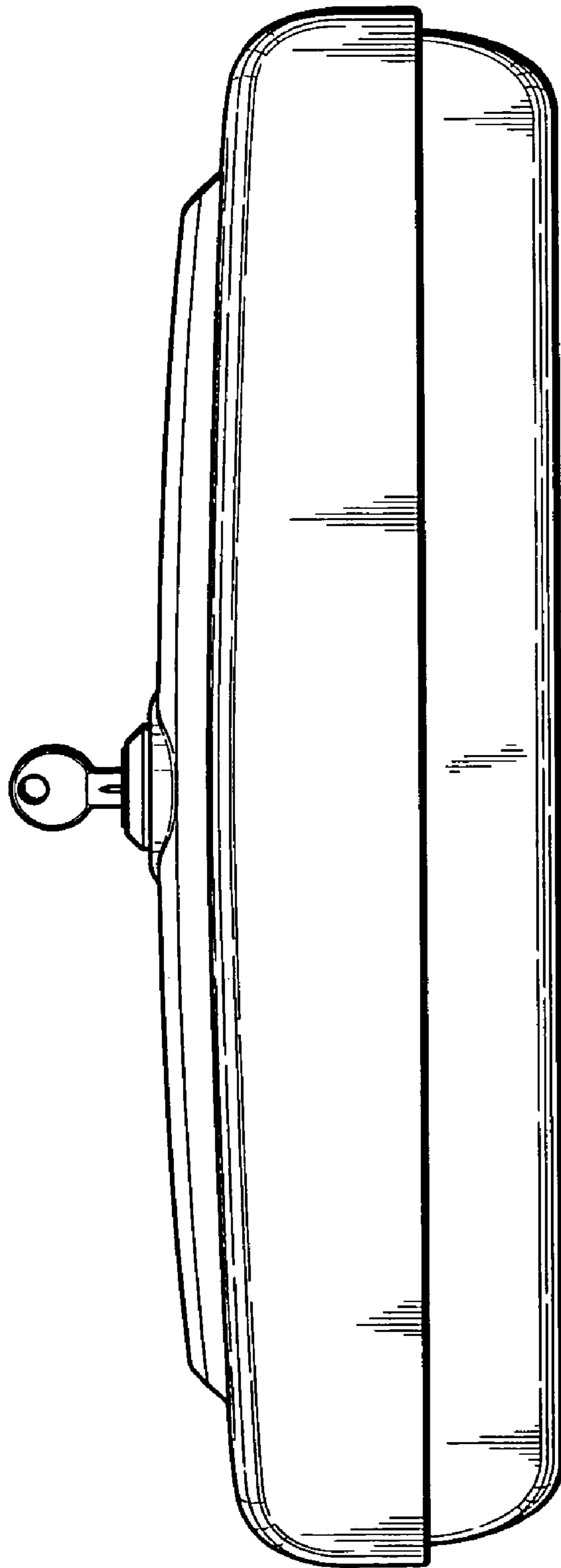

FIGURE 19

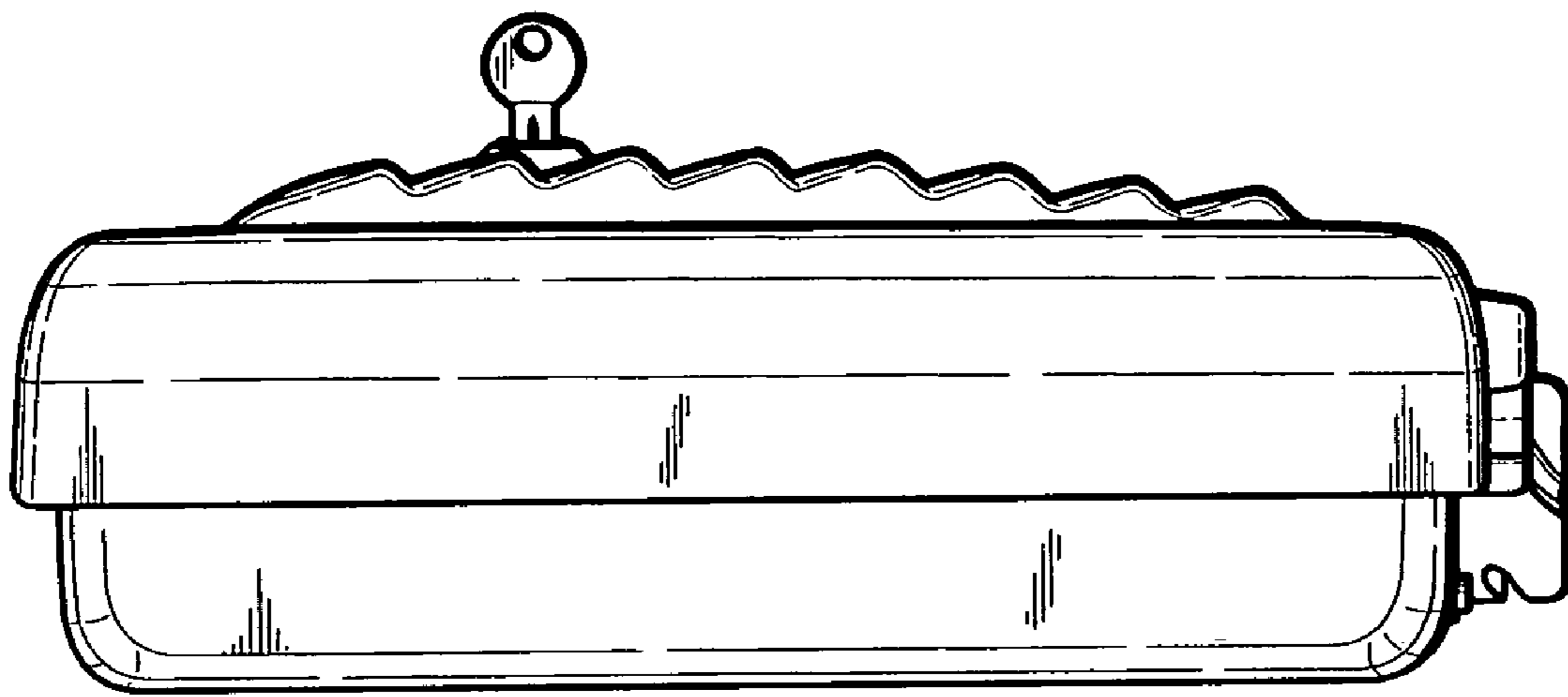

FIGURE 20

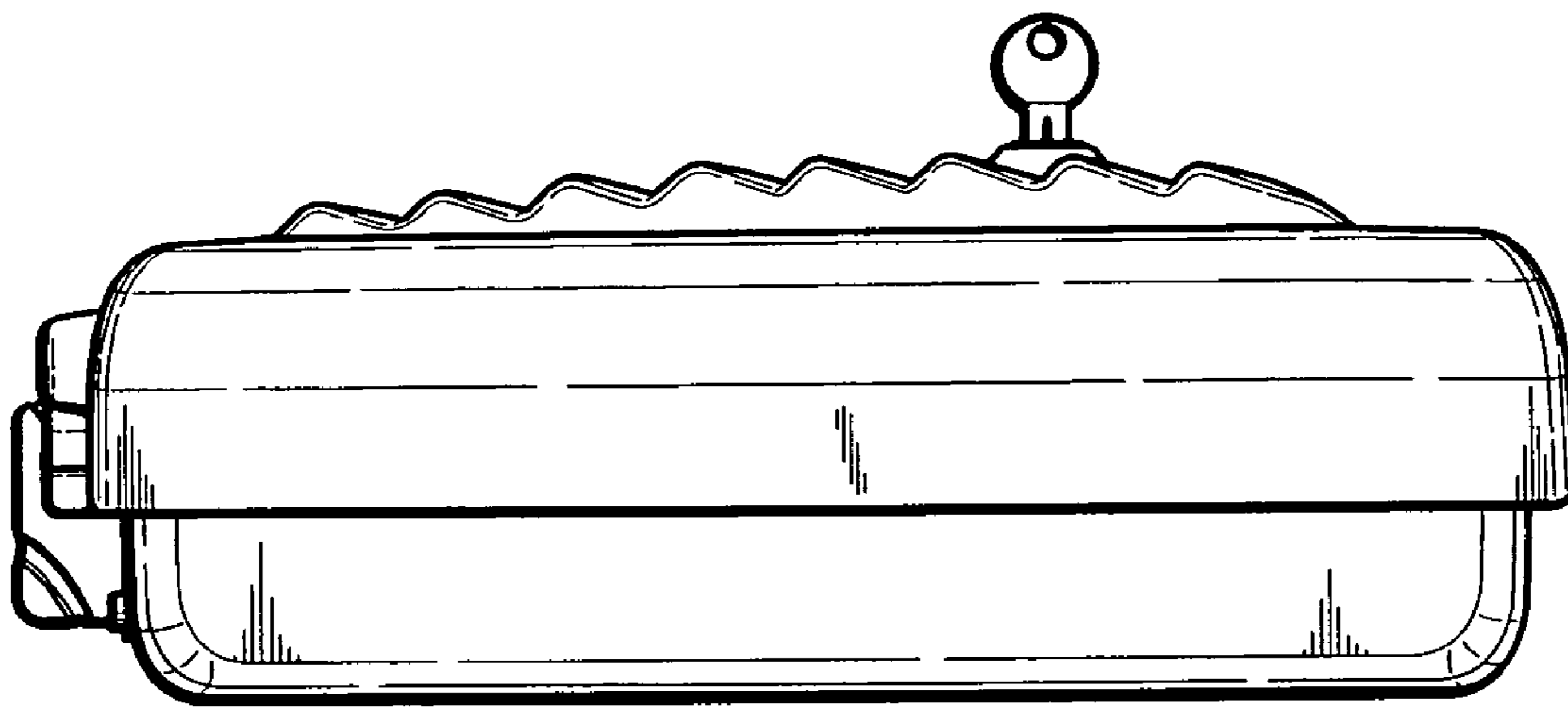

FIGURE 21