



US00D587164S

(12) **United States Design Patent**
Baker

(10) **Patent No.:** **US D587,164 S**

(45) **Date of Patent:** **** Feb. 24, 2009**

(54) **GIRL ICHTHY EMBLEM**

D548,057 S * 8/2007 Kelleghan D8/356

(76) Inventor: **Shawn Baker**, 785 Florland, Saint Louis, MO (US) 63031

(**) Term: **14 Years**

(21) Appl. No.: **29/310,273**

(22) Filed: **Aug. 6, 2008**

(51) **LOC (9) Cl.** **11-02**

(52) **U.S. Cl.** **D11/131**

(58) **Field of Classification Search** D11/131-135,
D11/157-158; 40/552, 564, 566, 470, 496,
40/606.06, 612, 617; D20/20-23, 27, 28,
D20/40

See application file for complete search history.

(56) **References Cited**

U.S. PATENT DOCUMENTS

| | | | | |
|--------------|---------|---------------|-------|---------|
| D137,768 S * | 4/1944 | Lehman et al. | | D20/30 |
| D200,870 S * | 4/1965 | Simpson | | D11/82 |
| D233,945 S * | 12/1974 | Burns | | D11/82 |
| D383,588 S * | 9/1997 | Morales | | D1/111 |
| D403,267 S * | 12/1998 | Burke | | D11/134 |
| D455,145 S * | 4/2002 | Williams | | D14/232 |
| D456,016 S * | 4/2002 | Denson | | D14/232 |
| D456,389 S * | 4/2002 | Denson | | D14/232 |
| D541,872 S * | 5/2007 | Houle | | D20/30 |

OTHER PUBLICATIONS

<http://www.stickergiant.com/page/sgPROD/gda/b2441>, Lawyer fish Plaque - Plastic With Adhesive, Copyright HC, Inc., 1997, 2 pages (printed Oct. 25, 2007).

Bettelheim, M. www.inklingmagazine.com/articles/evolutions-bumper - "Evolution's Bumper Sticker War Against Intelligent Design," Inkling Magazine, Apr. 5, 2007, 4 pages.

* cited by examiner

Primary Examiner—Louis S Zarfaz

Assistant Examiner—Michelle E Wilson

(57) **CLAIM**

The ornamental design for a girl ichthy emblem, as shown and described.

DESCRIPTION

FIG. 1 is an elevated perspective view of the girl ichthy emblem, showing my new design;

FIG. 2 is a side view thereof;

FIG. 3 is an opposing side view thereof;

FIG. 4 is a top view thereof;

FIG. 5 is a bottom view thereof;

FIG. 6 is a front view thereof; and,

FIG. 7 is a rear view thereof.

1 Claim, 1 Drawing Sheet

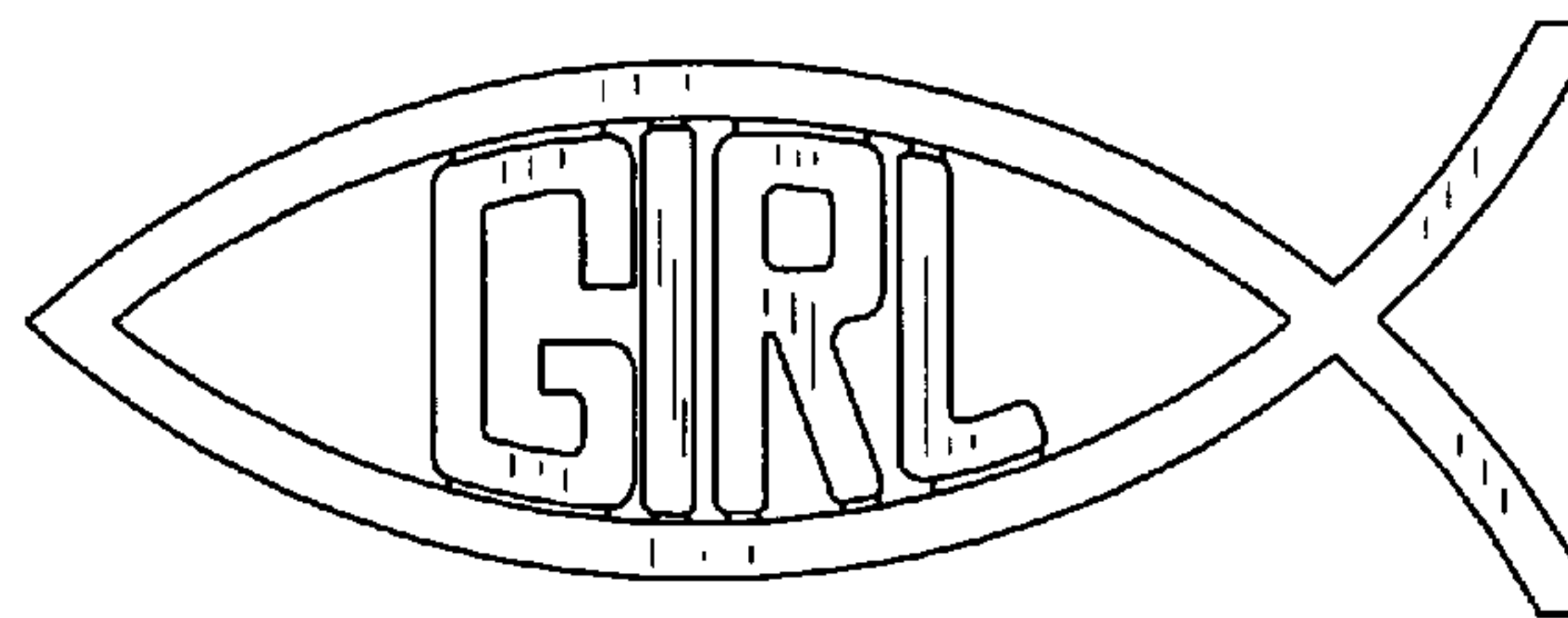
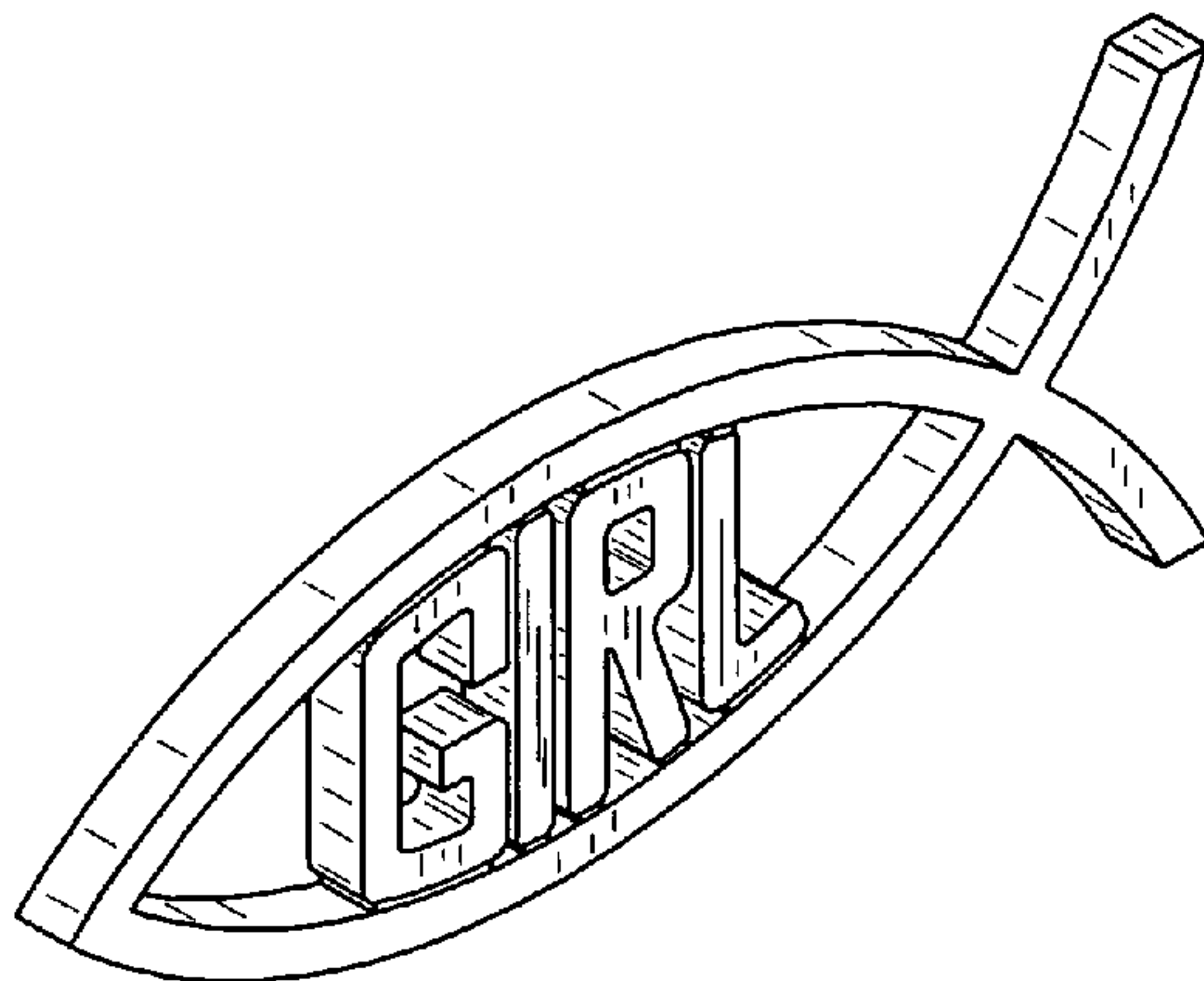

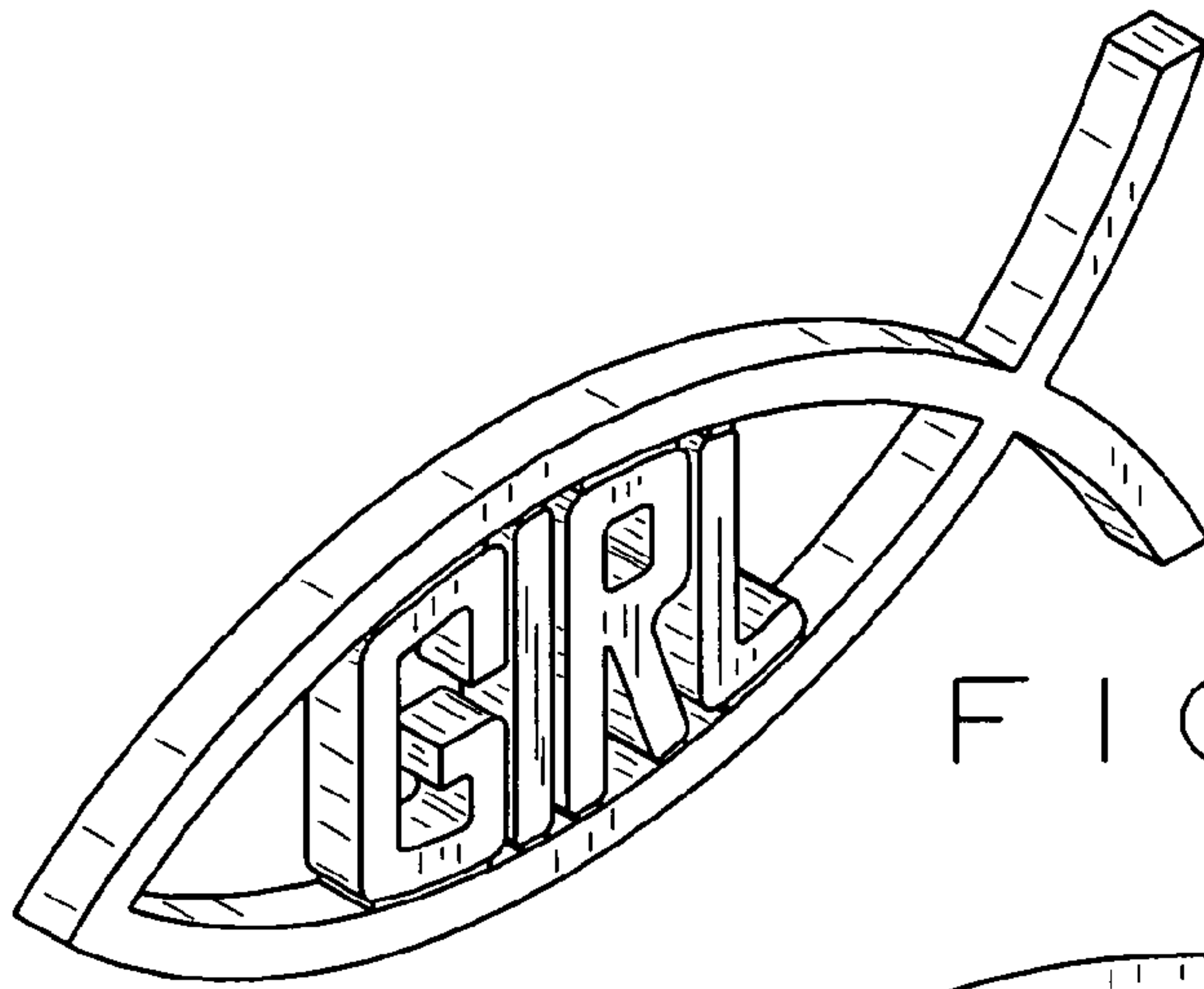

FIG. 1

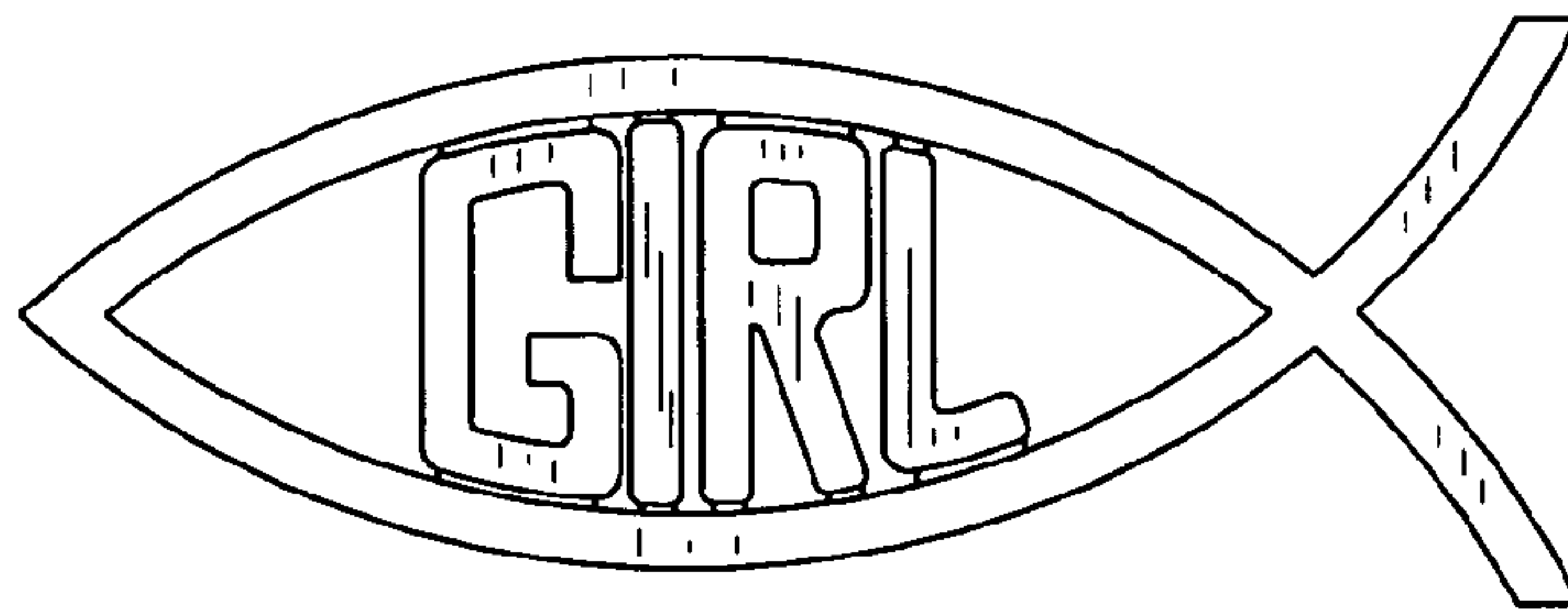

FIG. 2

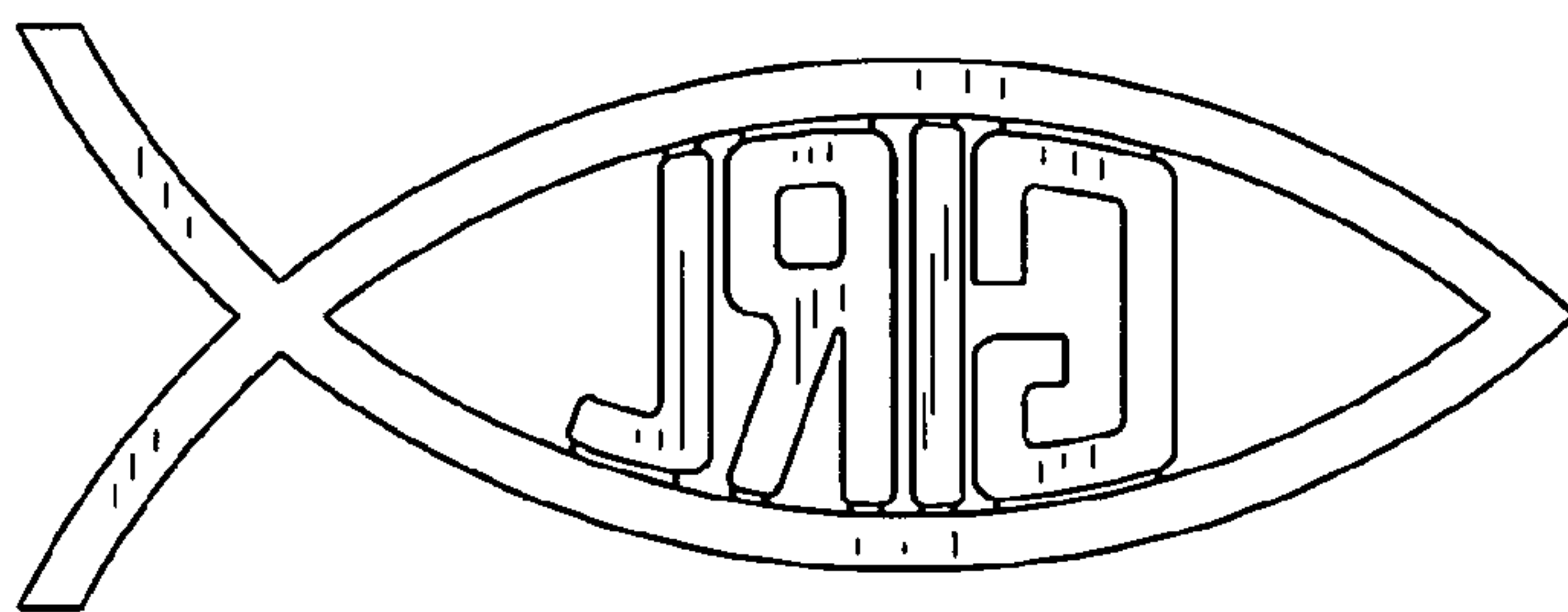

FIG. 3

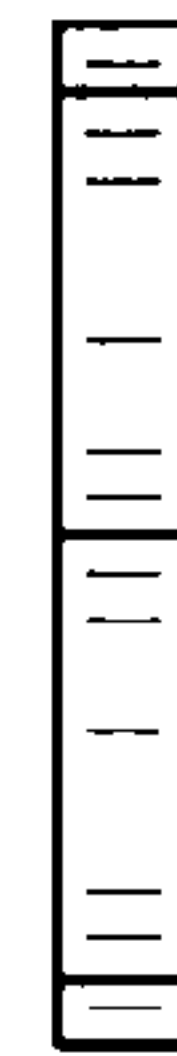

FIG. 6



FIG. 4



FIG. 5

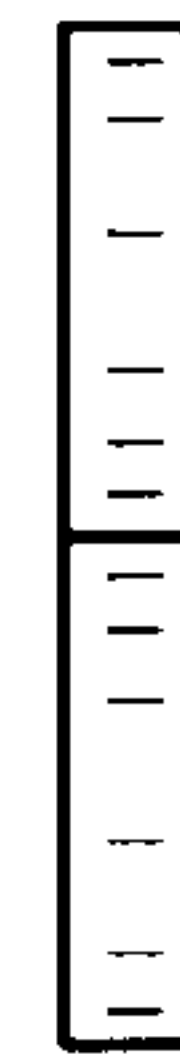

FIG. 7