



US00D587075S

(12) **United States Design Patent**
Dibnah et al.

(10) **Patent No.:** **US D587,075 S**
(45) **Date of Patent:** **** Feb. 24, 2009**

(54) **SPATULA**

(75) Inventors: **Carl Dibnah**, Hull (GB); **Chris Padain**, Hull (GB); **Tom Walker**, Bristol (GB); **Craig Wightman**, Bristol (GB)

(73) Assignee: **Reckitt Benckiser (UK) Limited**, Berkshire (GB)

(**) Term: **14 Years**

(21) Appl. No.: **29/307,543**

(22) Filed: **Apr. 25, 2008**

(30) **Foreign Application Priority Data**

Nov. 1, 2007 (EM) 000818851-0005

(51) **LOC (9) Cl.** **07-02**

(52) **U.S. Cl.** **D7/688; D28/7; D28/9**

(58) **Field of Classification Search** D7/688, D7/669; D28/4, 7, 9, 99; D8/14, 16, 19, D8/47, 45, 88; 30/169; 294/7, 8, 1.1
See application file for complete search history.

(56) **References Cited**

U.S. PATENT DOCUMENTS

2,425,917 A * 8/1947 Brignola 606/161

2,824,369 A * 2/1958 Welch D0/324
4,536,910 A * 8/1985 Clark 15/245.1
6,453,562 B1 * 9/2002 Hakim 30/324
D482,578 S * 11/2003 Kortleven et al. D7/692
D491,419 S * 6/2004 White et al. D7/653
D496,231 S * 9/2004 Germany D7/688
D509,024 S * 8/2005 Pimentel D28/7
D516,392 S * 3/2006 de Vries D7/688
D518,597 S * 4/2006 Sommers D28/7

* cited by examiner

Primary Examiner—Terry A Wallace

(74) *Attorney, Agent, or Firm*—TraskBritt

(57) **CLAIM**

The ornamental design for a spatula, as shown and described.

DESCRIPTION

FIG. 1 is a perspective view showing a new design;

FIG. 2 is a top view of the new design;

FIG. 3 is a bottom view of the new design;

FIG. 4 is a front view of the new design;

FIG. 5 is a rear view of the new design;

FIG. 6 is a right side view of the design; and,

FIG. 7 is a left side view of the design.

1 Claim, 1 Drawing Sheet

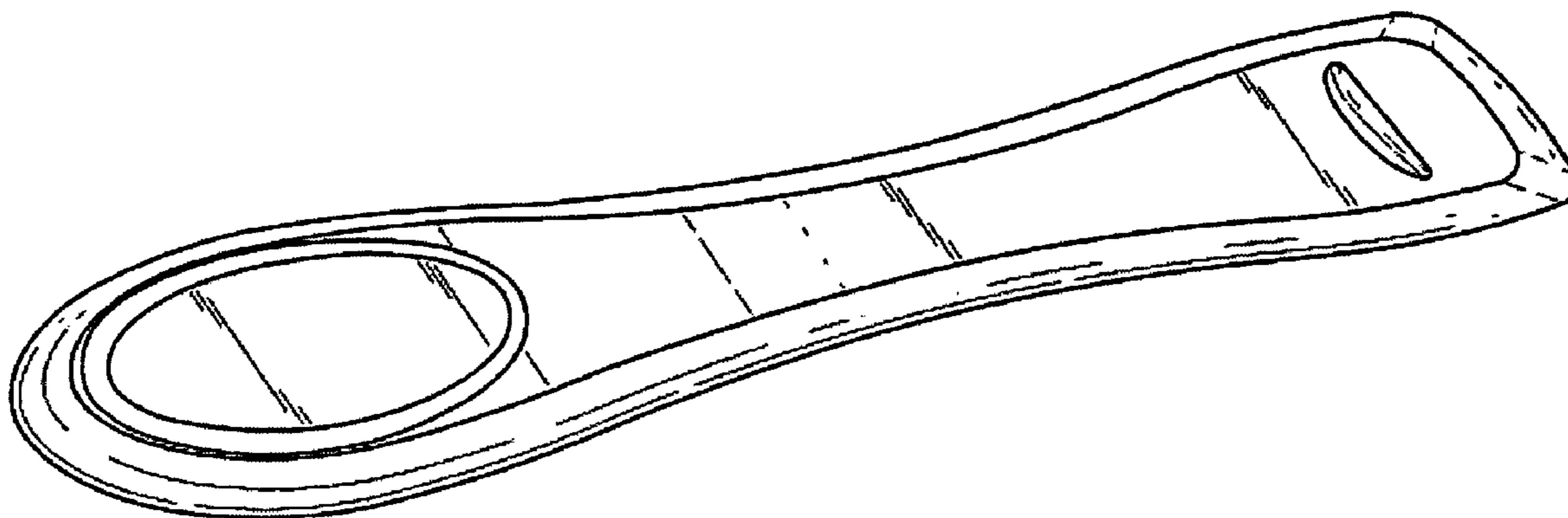

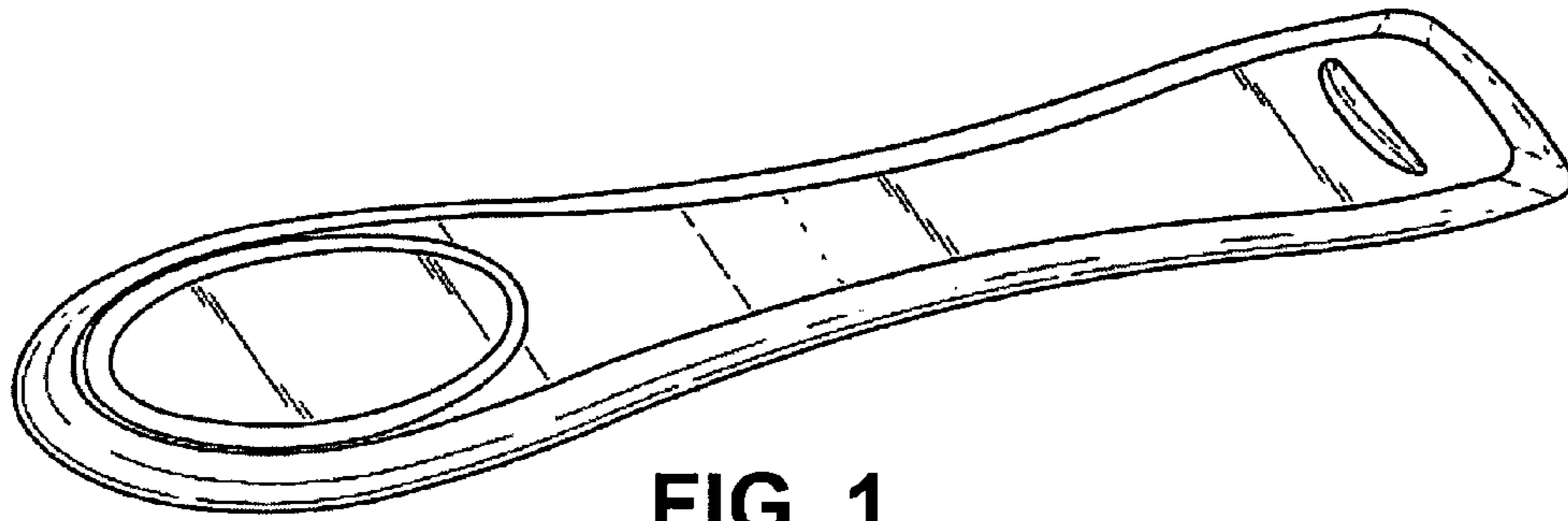

FIG. 1

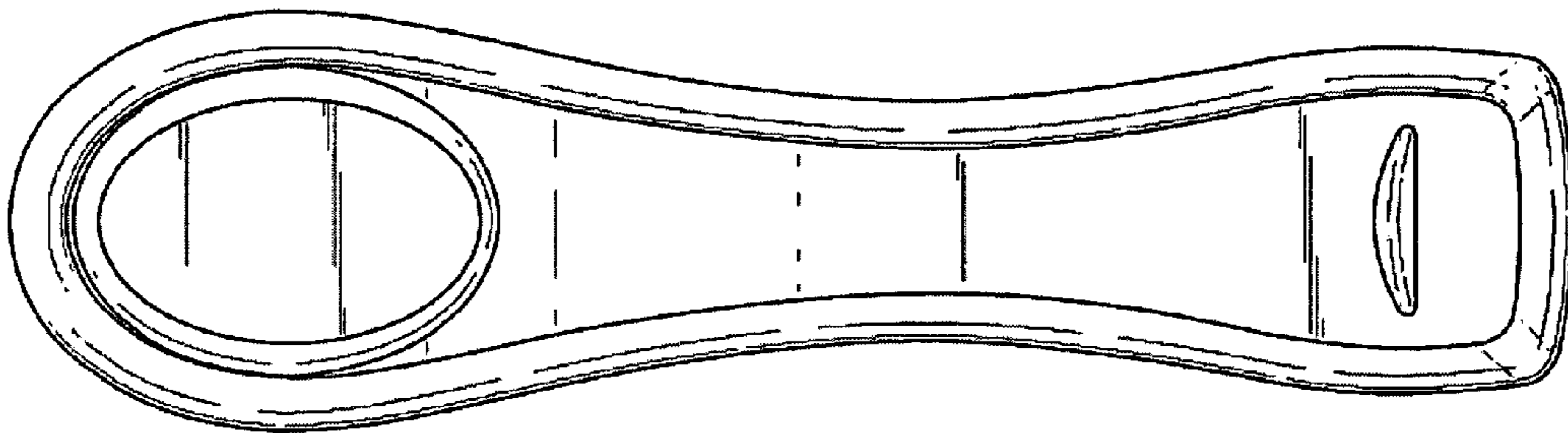

FIG. 2

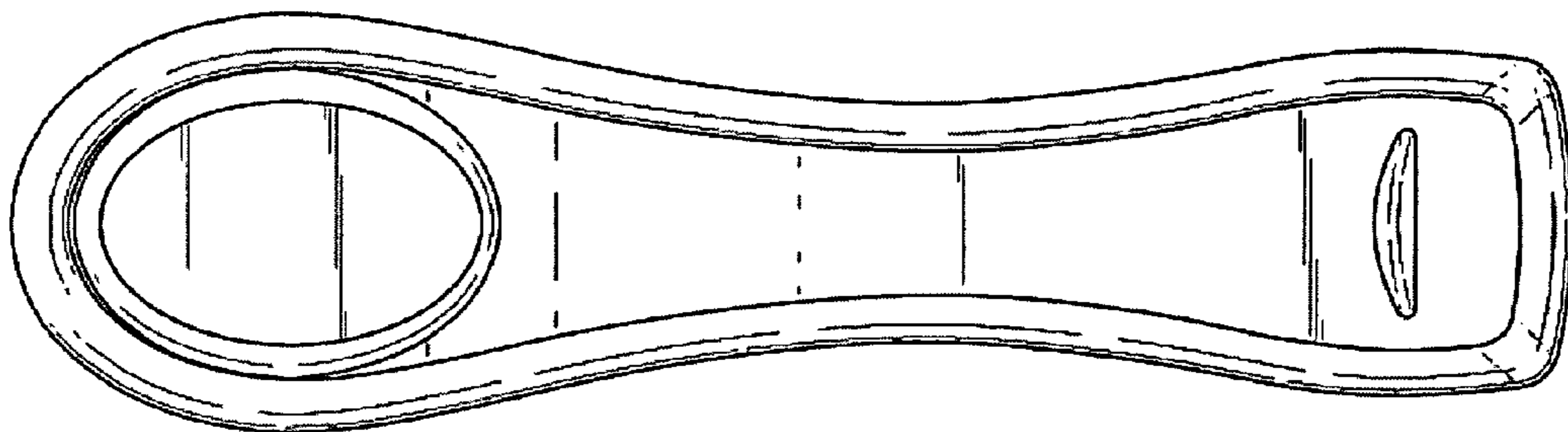

FIG. 3

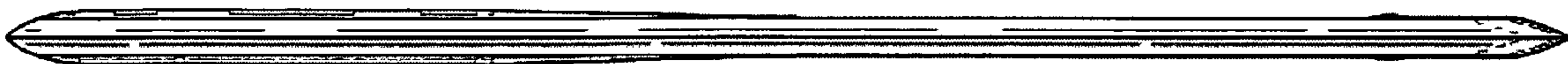

FIG. 4

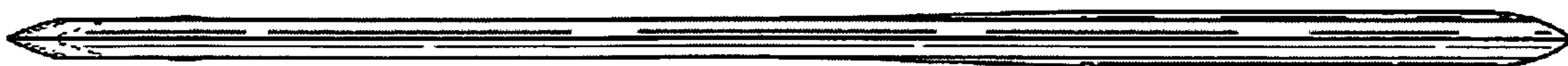

FIG. 5

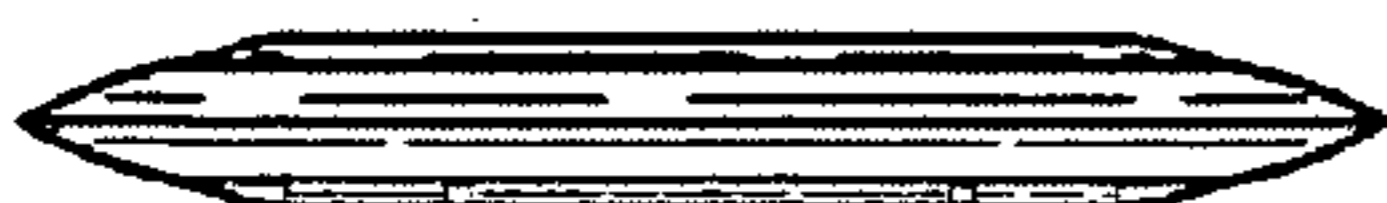

FIG. 6



FIG. 7