



US00D587007S

(12) **United States Design Patent**
Phillips, III

(10) **Patent No.:** **US D587,007 S**

(45) **Date of Patent:** **** Feb. 24, 2009**

(54) **HYDRATION PACK**

(76) **Inventor:** **Rene V. Phillips, III**, 2043 Bridge Cross
La., Houston, TX (US) 77067

(**) **Term:** **14 Years**

(21) **Appl. No.:** **29/282,259**

(22) **Filed:** **Jul. 16, 2007**

(51) **LOC (9) Cl.** **03-01**

(52) **U.S. Cl.** **D3/216**

(58) **Field of Classification Search** D3/202,
D3/216, 217, 254, 273, 318, 221, 326, 327,
D3/290, 300, 303, 907; 224/153, 254, 259;
53/452, 410, 469; 222/148.1, 148.2, 148.3,
222/148.5, 627, 153; 215/306, 311; 220/703,
220/705, 212.5

See application file for complete search history.

(56) **References Cited**

U.S. PATENT DOCUMENTS

D321,980	S	*	12/1991	Billet	D7/305
D333,565	S	*	3/1993	Imbert	D3/217
5,427,290	A	*	6/1995	Thatcher	224/148.2
D411,658	S	*	6/1999	Stump	D3/216
5,975,387	A	*	11/1999	Gleason et al.	224/148.2
6,247,619	B1	*	6/2001	Gill et al.	222/105
6,837,026	B2	*	1/2005	Setton	53/412
6,908,015	B2	*	6/2005	Choi et al.	222/175
D517,800	S	*	3/2006	de Baschmakoff	D3/217
D553,350	S	*	10/2007	Dvorak	D3/217

7,331,231	B2	*	12/2007	Noell et al.	224/148.2
7,398,891	B2	*	7/2008	Yang	220/212.5

* cited by examiner

Primary Examiner—Ian Simmons

Assistant Examiner—Anna J Burmeister

(74) *Attorney, Agent, or Firm*—Egbert Law Offices PLLC

(57) **CLAIM**

The ornamental design for a hydration pack, as shown and described.

DESCRIPTION

FIG. 1 is an upper perspective view of the hydration pack showing my design.

FIG. 2 is a front view thereof;

FIG. 3 is a back view thereof;

FIG. 4 is a side view thereof;

FIG. 5 is an opposite side view thereof;

FIG. 6 is top view thereof;

FIG. 7 is a bottom view thereof;

FIG. 8 is another upper perspective view, showing the flap in an open position; and,

FIG. 9 is another perspective view, showing both the flap and zippered pouch in an open position.

The dashed lines shown in the drawing views represent a stitching line.

1 Claim, 3 Drawing Sheets

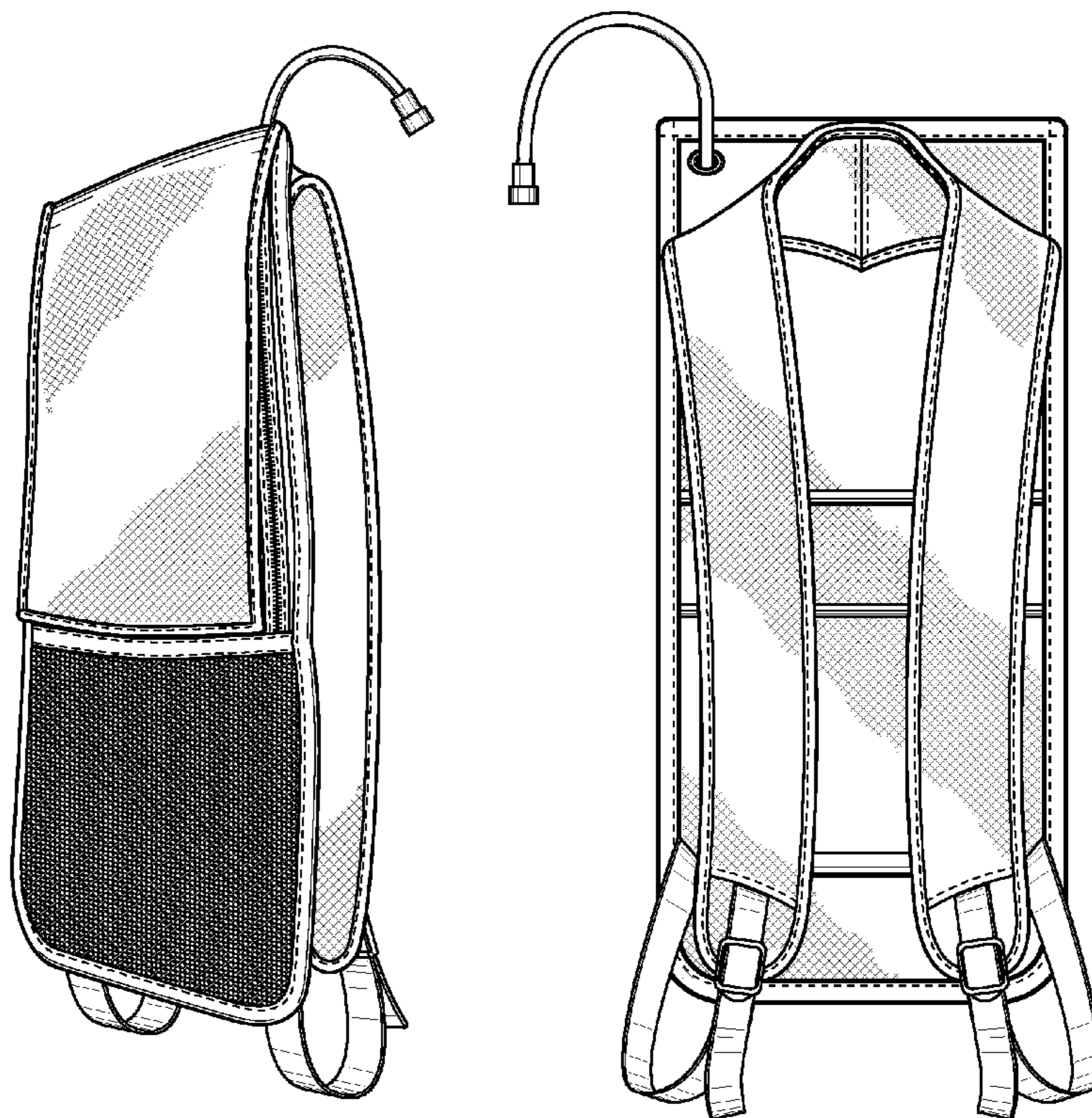

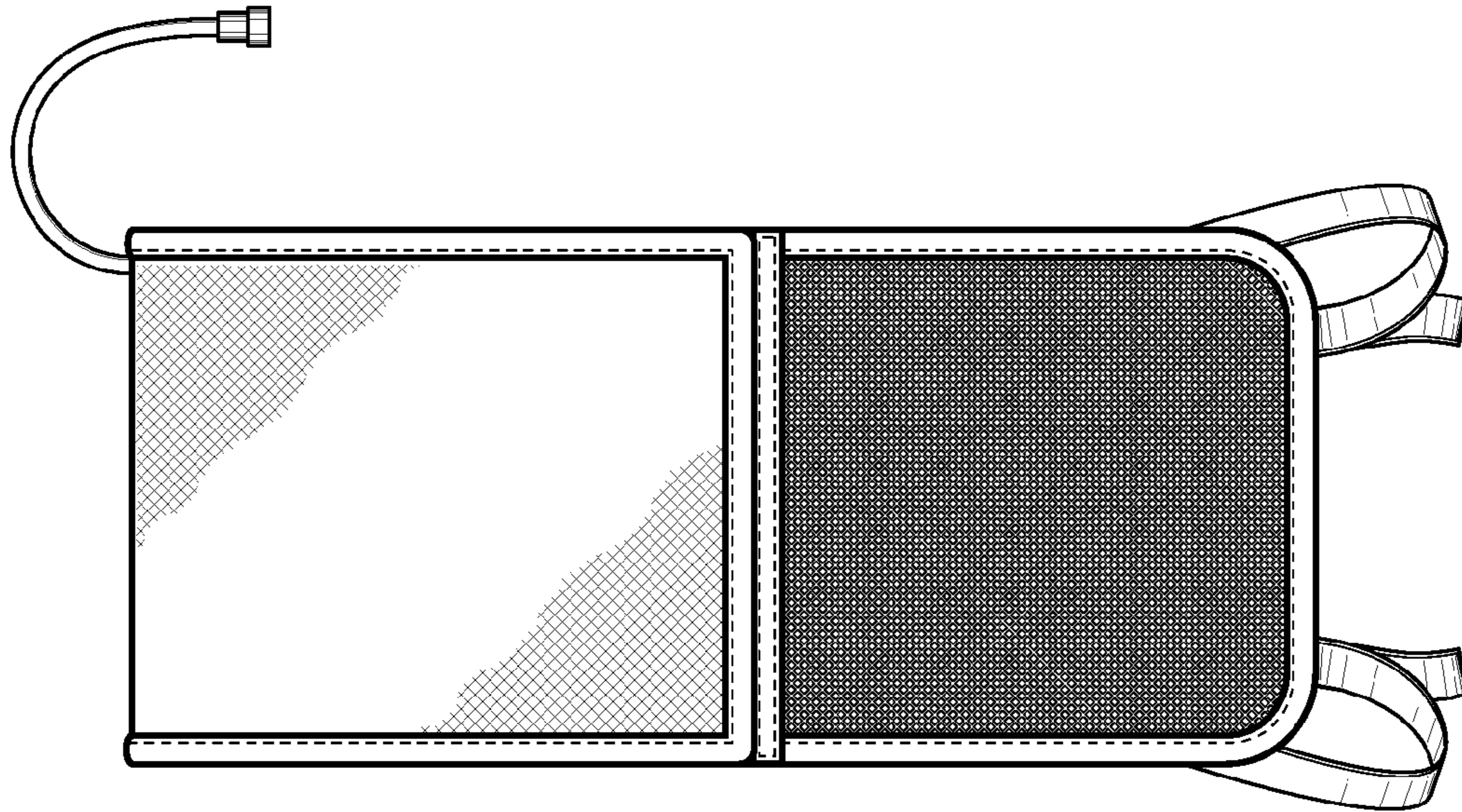

FIG. 2

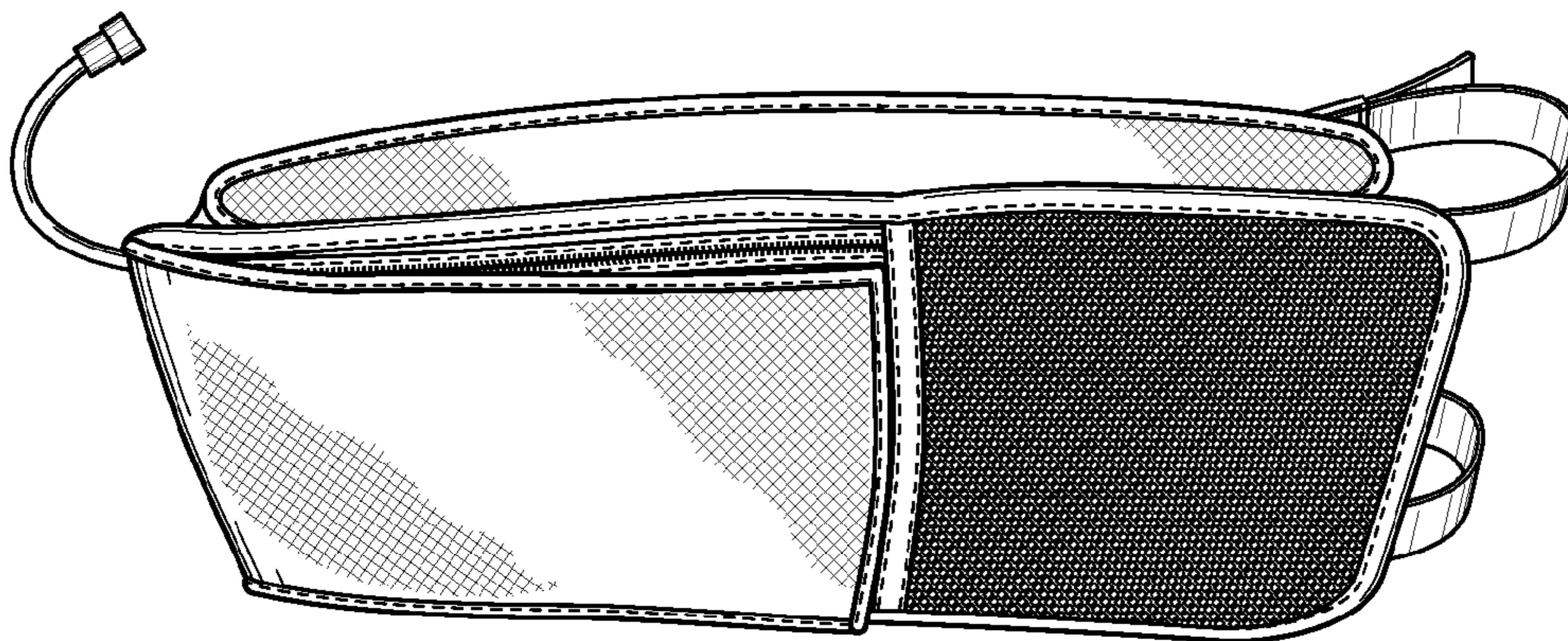

FIG. 1

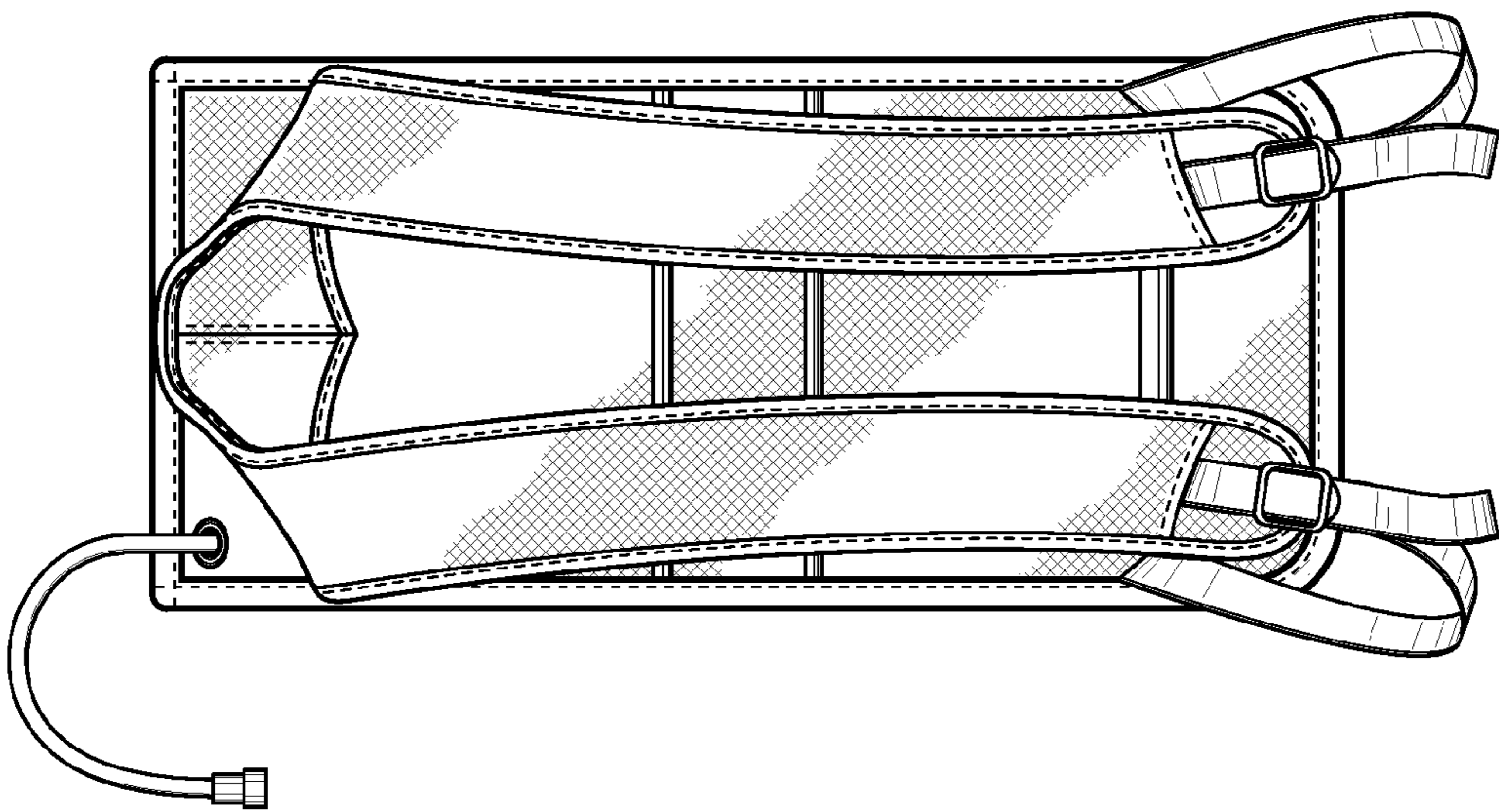

FIG. 3

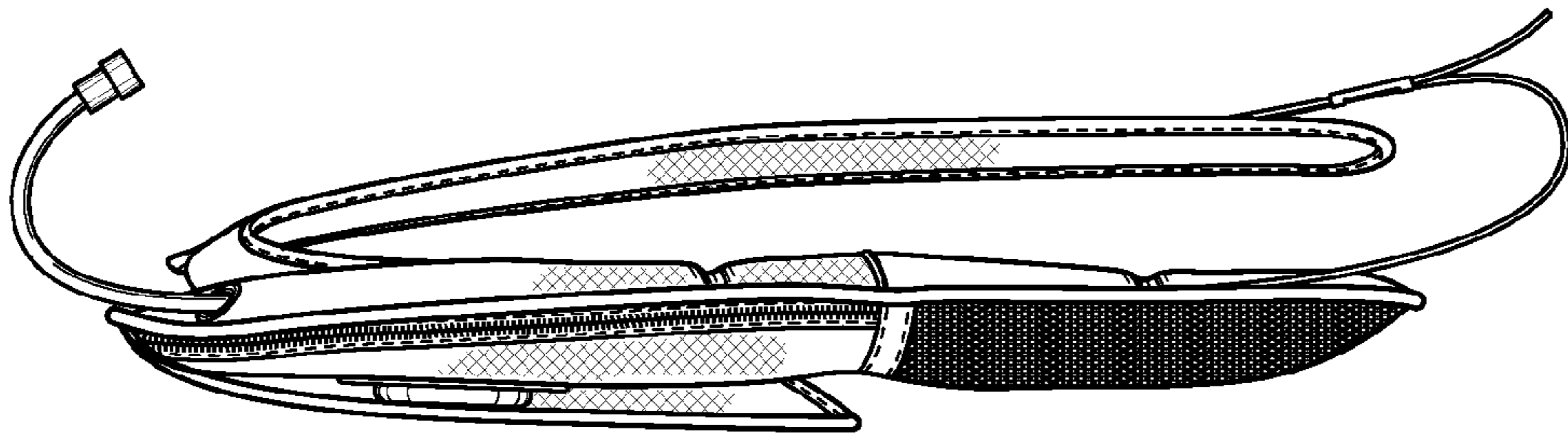

FIG. 4

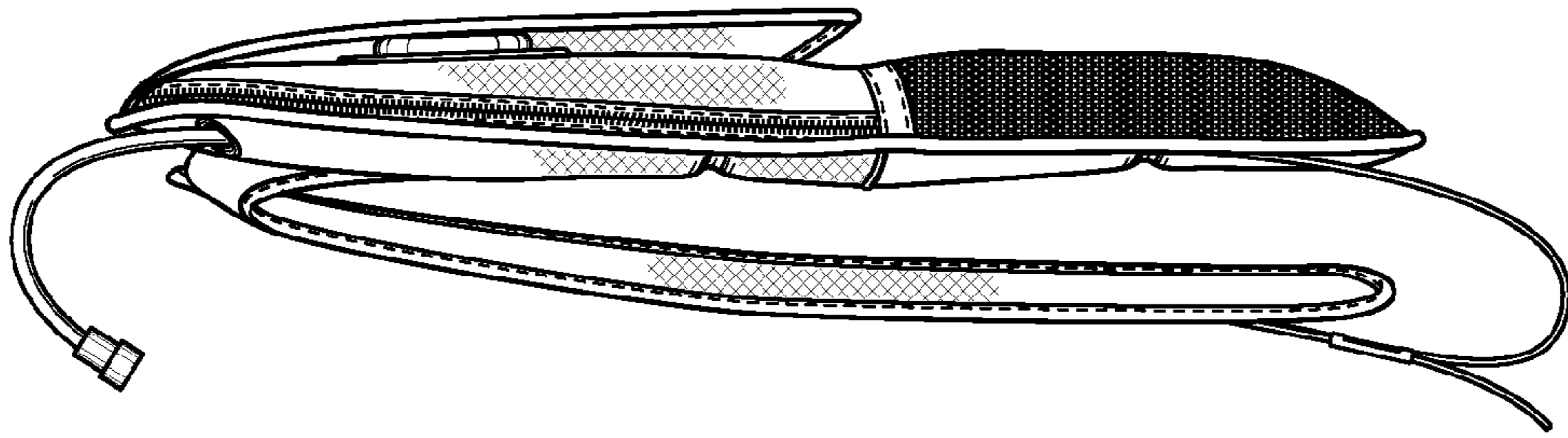

FIG. 5

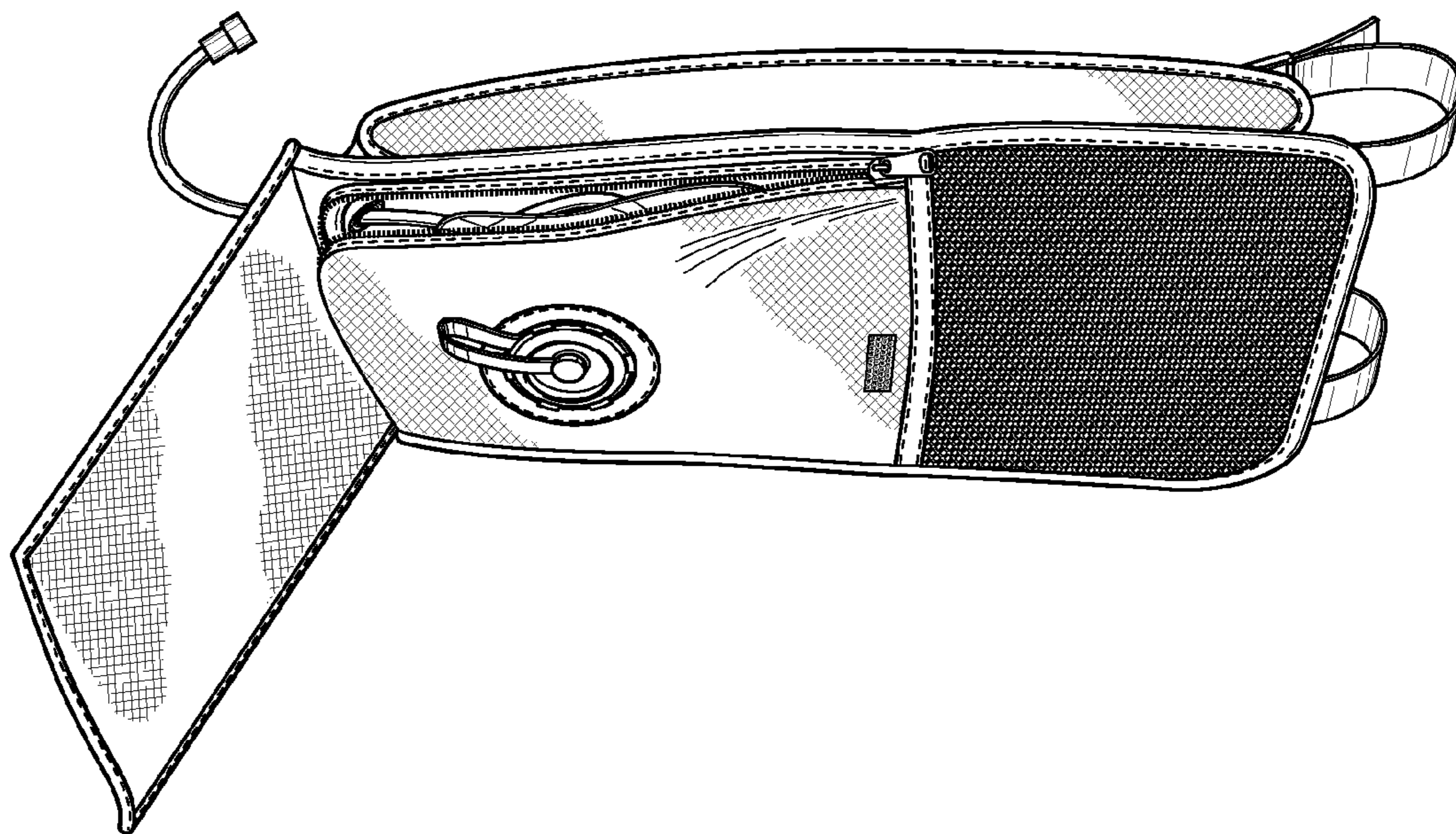

FIG. 9

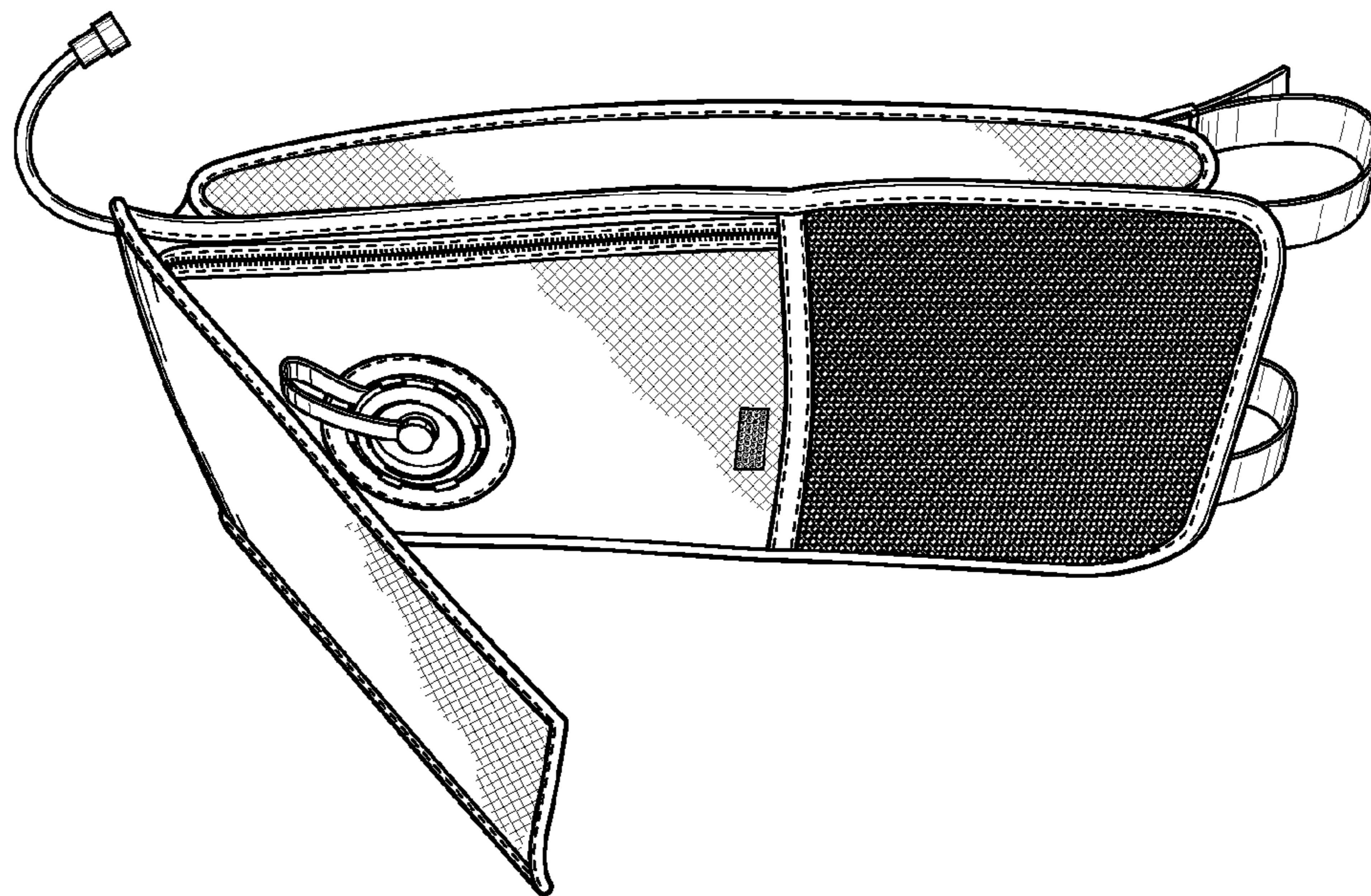

FIG. 8

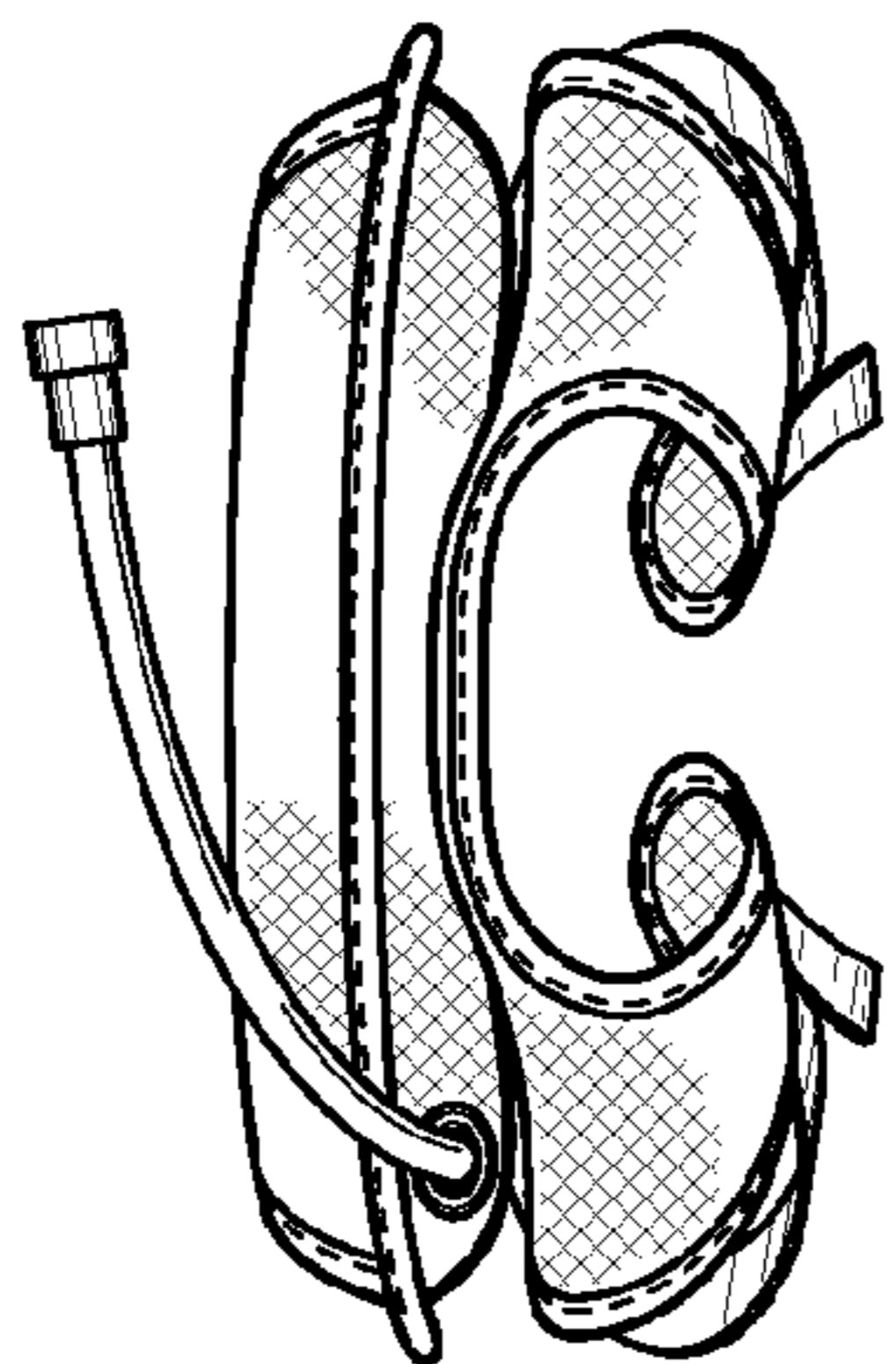

FIG. 6

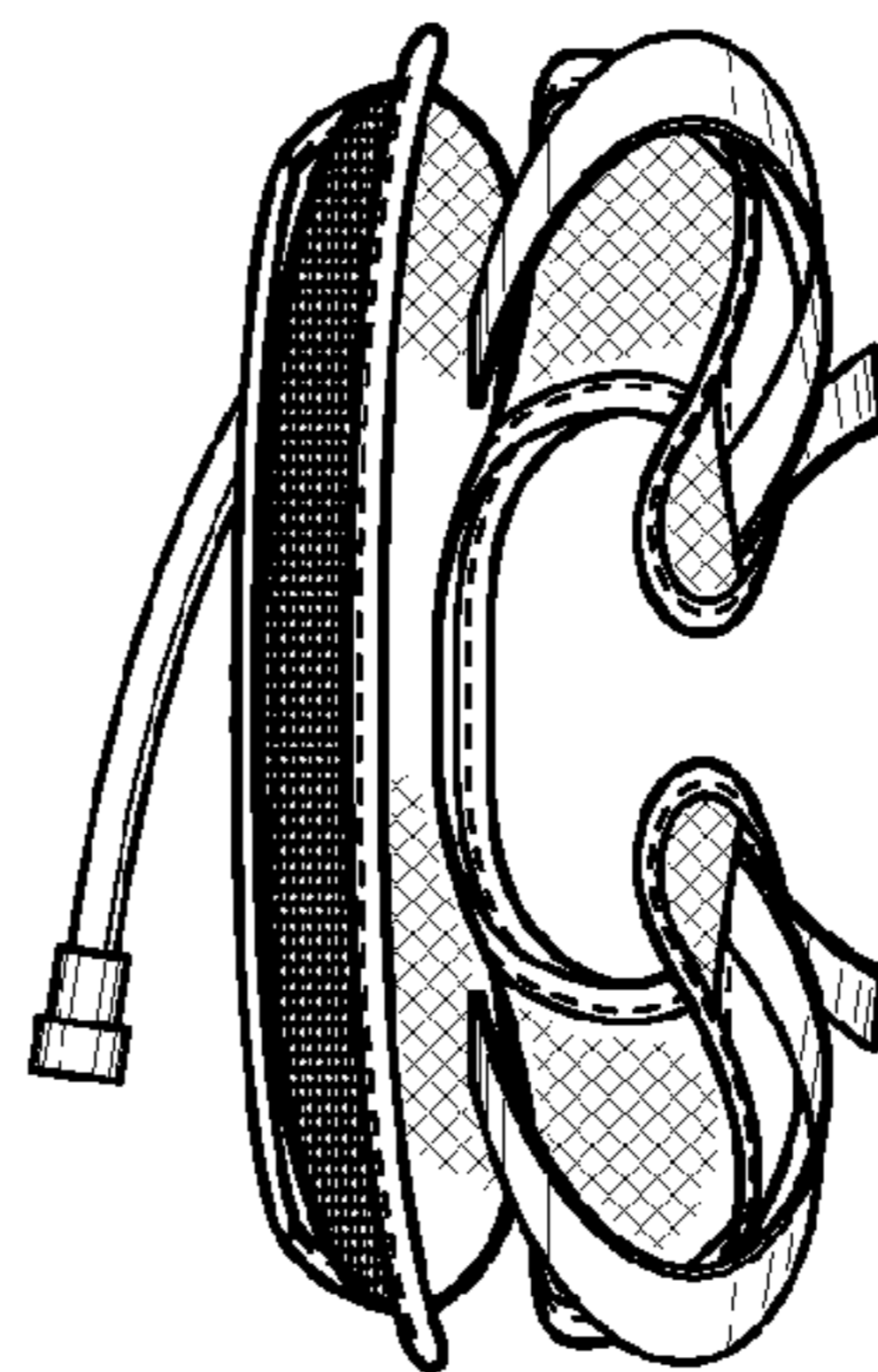

FIG. 7