



US00D586968S

(12) **United States Design Patent**  
**Libman et al.**

(10) **Patent No.:** **US D586,968 S**  
(45) **Date of Patent:** **\*\* Feb. 17, 2009**

(54) **PORTION OF A MOP HANDLE**  
(75) Inventors: **Robert J. Libman**, Arcola, IL (US);  
**Enzo Berti**, Pianiga (IT)  
(73) Assignee: **The Libman Company**, Arcola, IL (US)  
(\*\*) Term: **14 Years**  
(21) Appl. No.: **29/298,440**  
(22) Filed: **Dec. 5, 2007**

5,181,369 A \* 1/1993 Everts ..... 56/12.7  
D368,005 S \* 3/1996 Lemcke ..... D8/8  
5,560,108 A \* 10/1996 Wilson ..... 30/276  
D406,225 S \* 3/1999 Searle et al. .... D8/107  
D479,024 S \* 8/2003 Libman ..... D32/52  
D511,032 S \* 10/2005 Roberts ..... D32/41

\* cited by examiner

*Primary Examiner*—Pamela J Burgess

(74) *Attorney, Agent, or Firm*—Banner & Witcoff, Ltd.

(51) **LOC (9) Cl.** ..... **04-01**  
(52) **U.S. Cl.** ..... **D32/52; D8/8**  
(58) **Field of Classification Search** ..... D32/50–52;  
D8/107, 8, 14, 75–77; D21/680–681; D15/16;  
30/122, 276, 347; 56/12.7, 17.5, 156–157,  
56/198, 235, 255, 339, 291–295; 29/254;  
16/110.1; 123/217; 173/90  
See application file for complete search history.

(57) **CLAIM**

The ornamental design for a portion of a mop handle, as shown and described.

**DESCRIPTION**

FIG. 1 is a front right perspective view of a portion of a mop handle showing our new design;  
FIG. 2 is a front view thereof;  
FIG. 3 is a rear view thereof;  
FIG. 4 is a right side view thereof;  
FIG. 5 is a left side view thereof;  
FIG. 6 is a top view thereof; and,  
FIG. 7 is a bottom view thereof.

The broken lines shown in the drawings are for illustrative purposes only and form no part of the claimed design.

(56) **References Cited**

**U.S. PATENT DOCUMENTS**

D255,764 S \* 7/1980 Lombard ..... D8/8  
D256,769 S \* 9/1980 Irelan ..... D8/8  
D301,009 S \* 5/1989 Pilatowicz et al. .... D8/8  
4,860,451 A \* 8/1989 Pilatowicz et al. .... 30/276  
D305,198 S \* 12/1989 White et al. .... D8/8  
D317,852 S \* 7/1991 Fujiwara et al. .... D8/8  
D320,398 S \* 10/1991 Clivio ..... D8/8

**1 Claim, 7 Drawing Sheets**

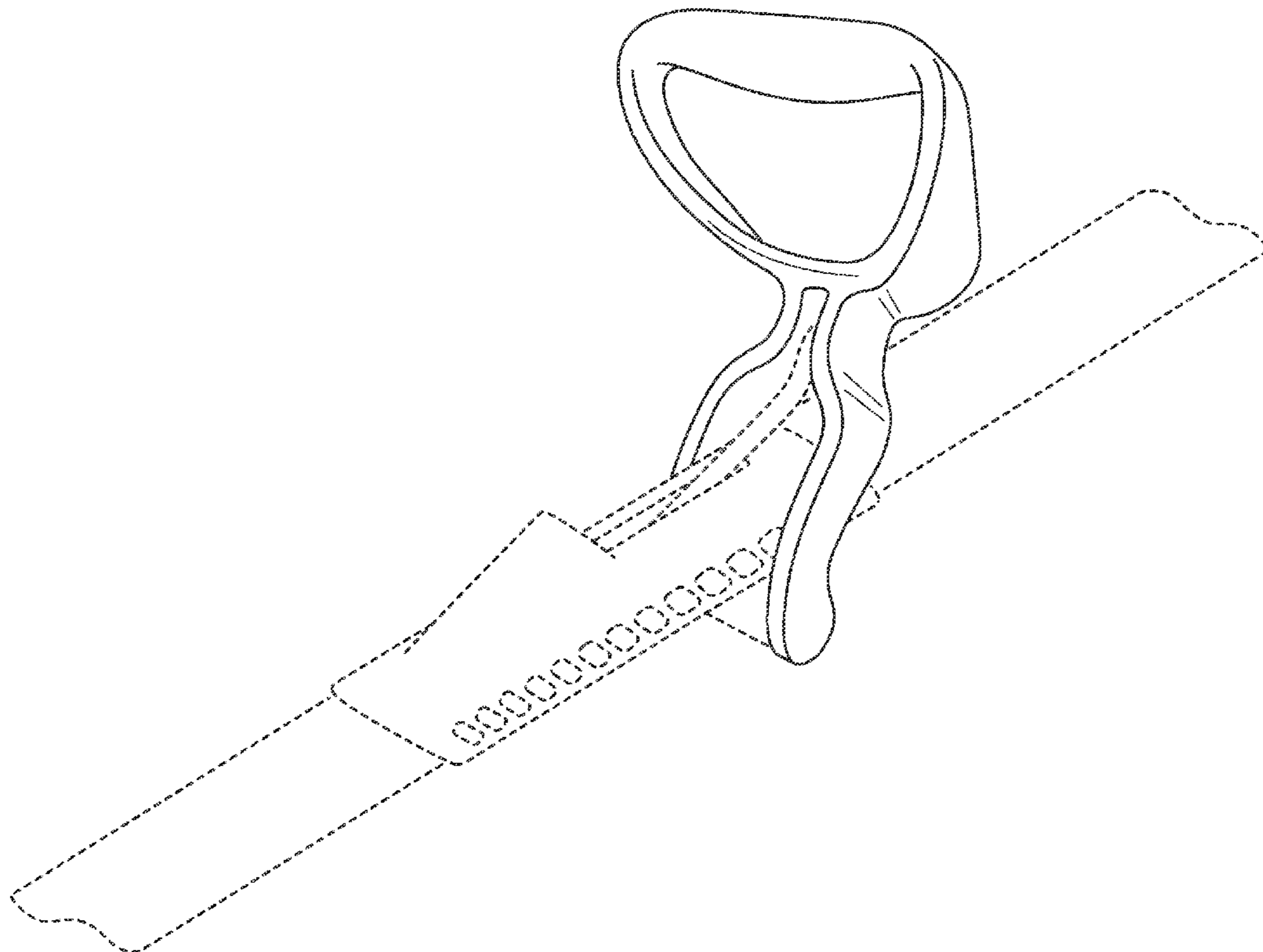

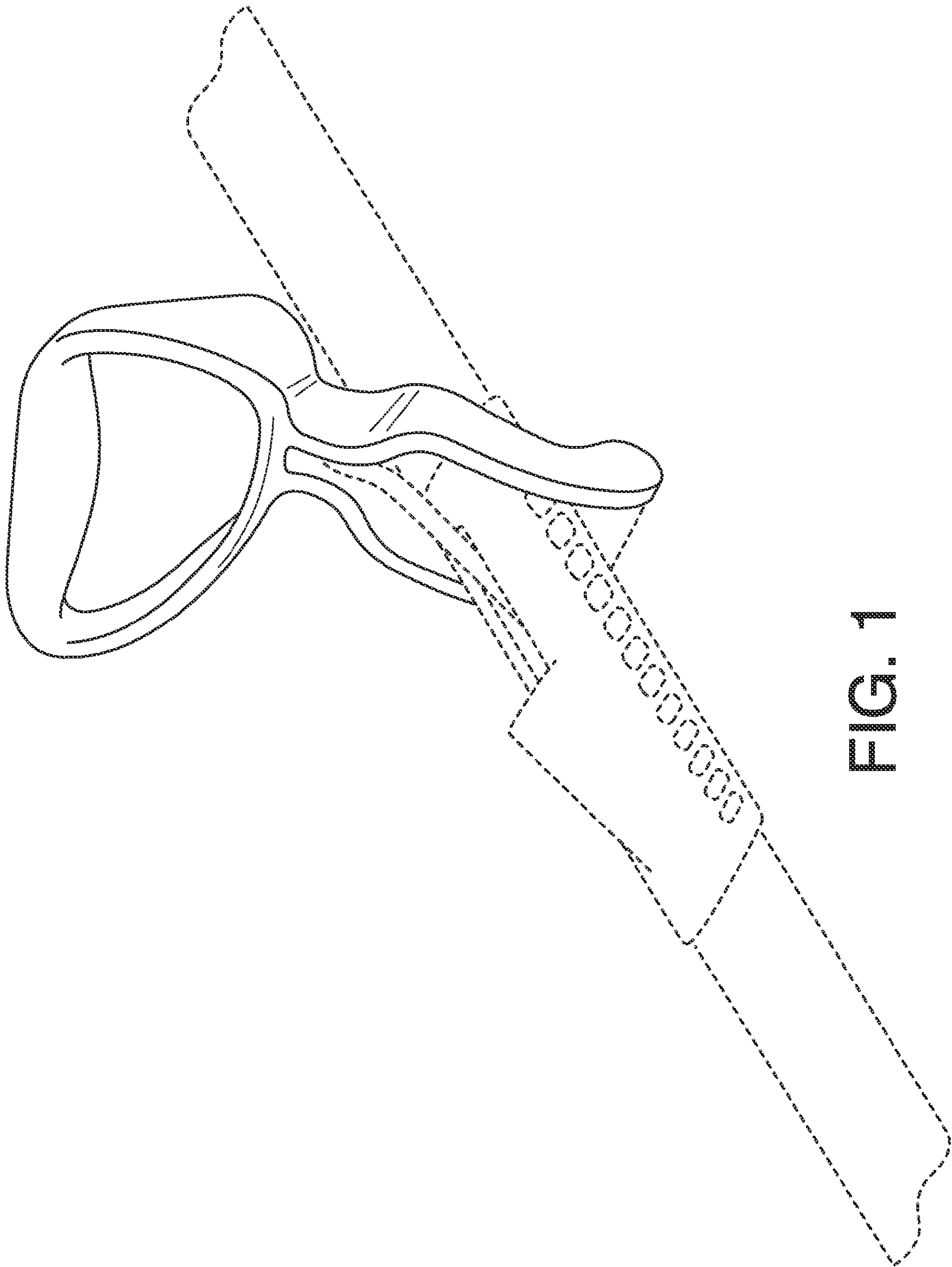

FIG. 1

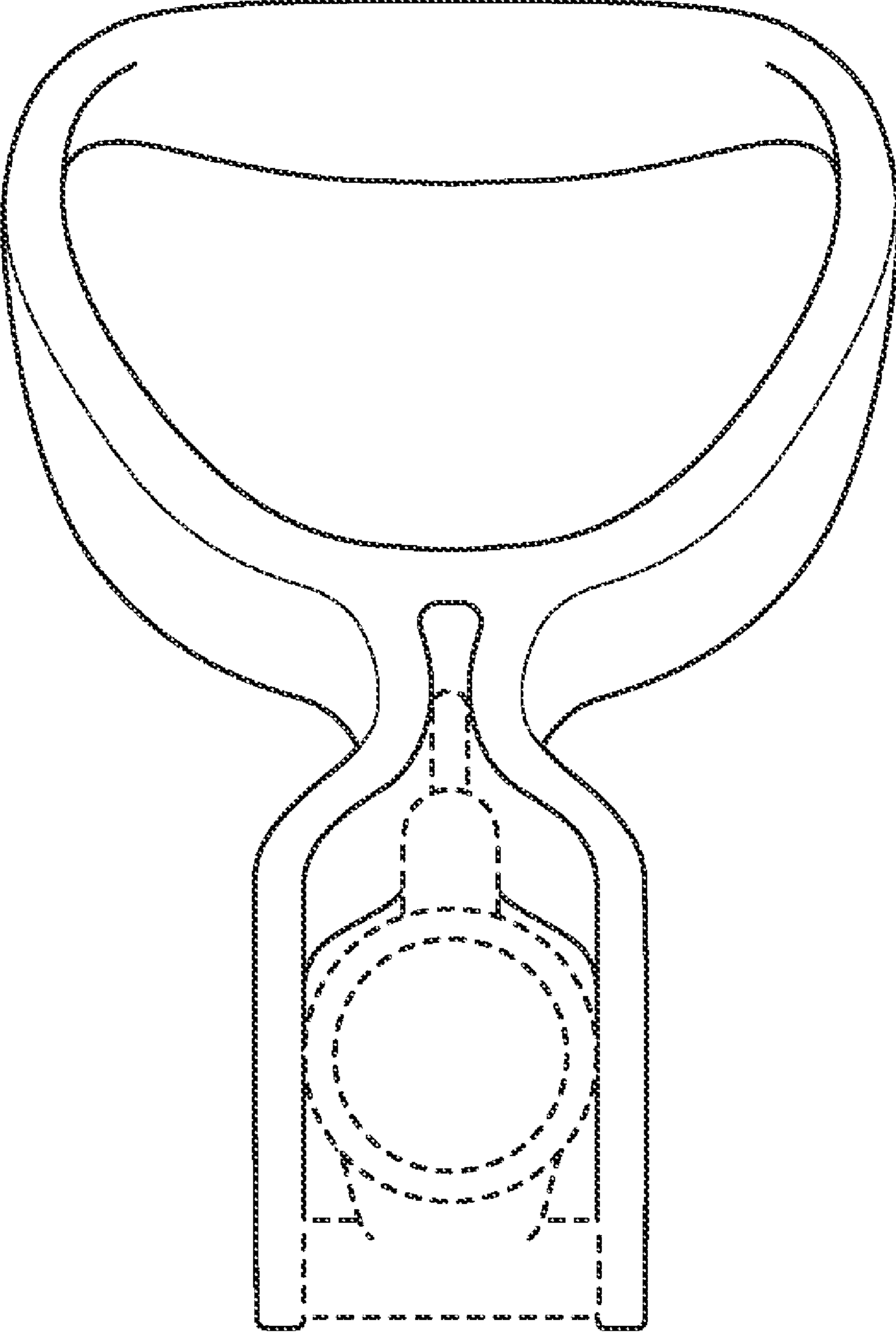

FIG. 2

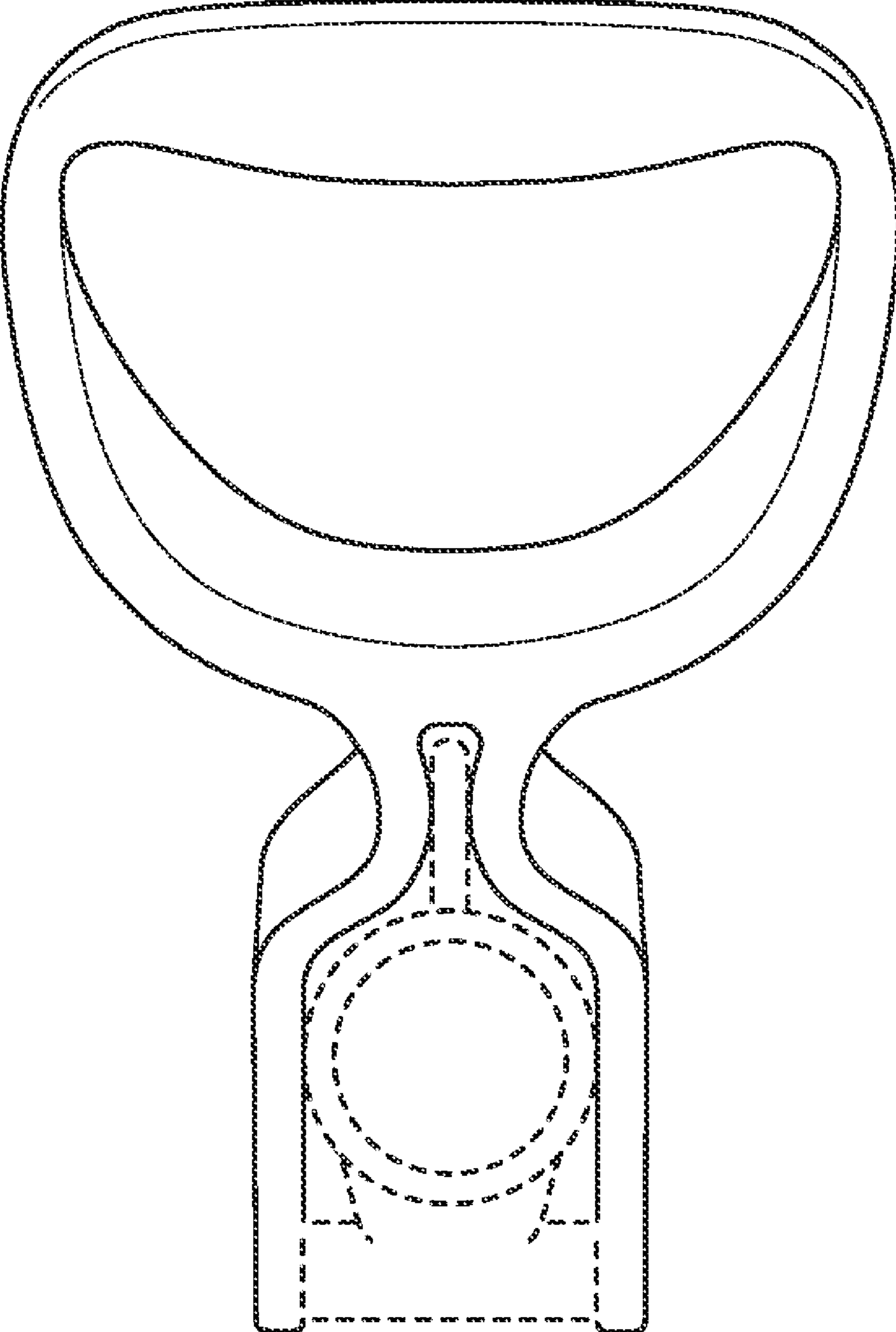

FIG. 3

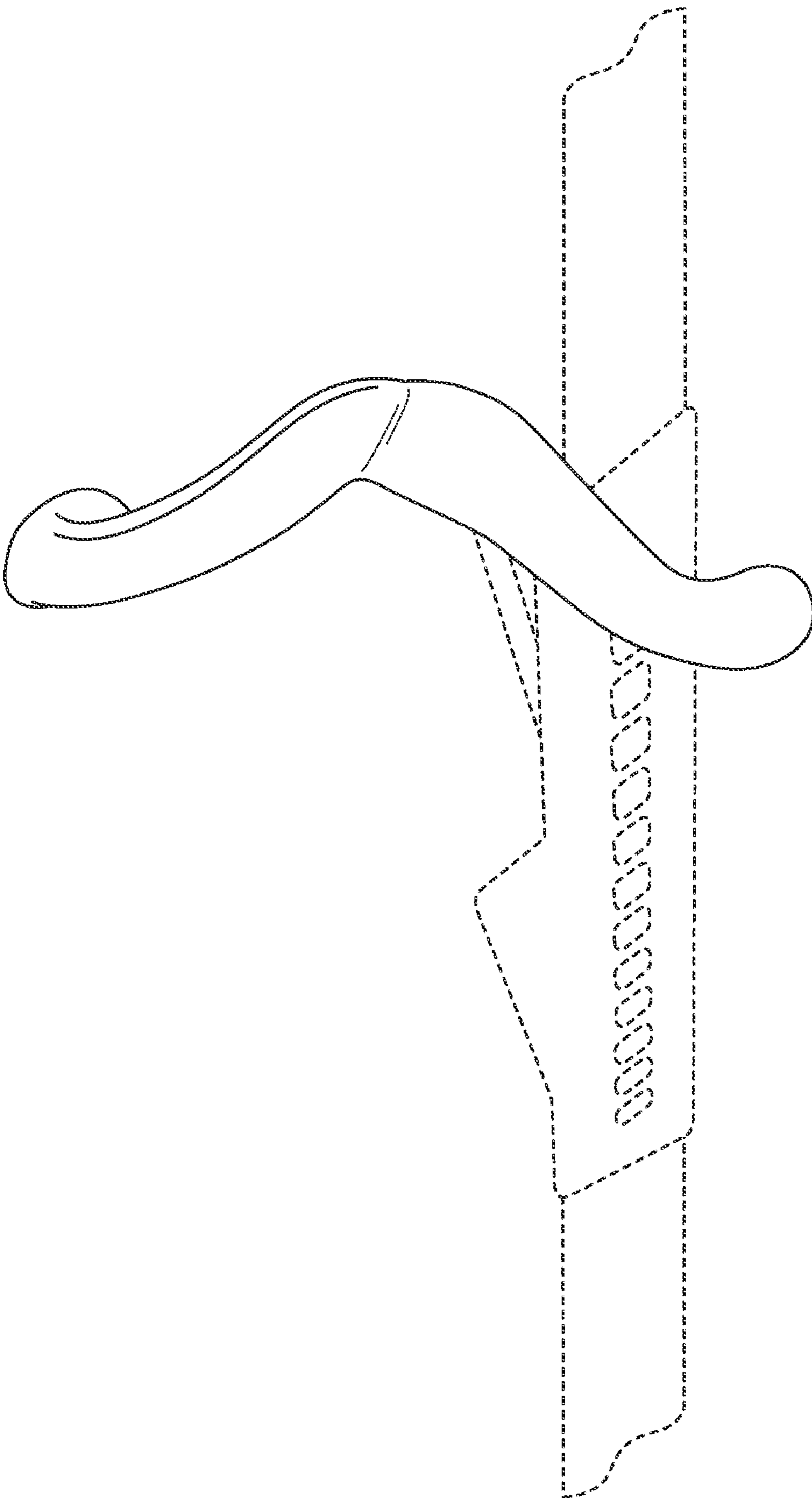

FIG. 4

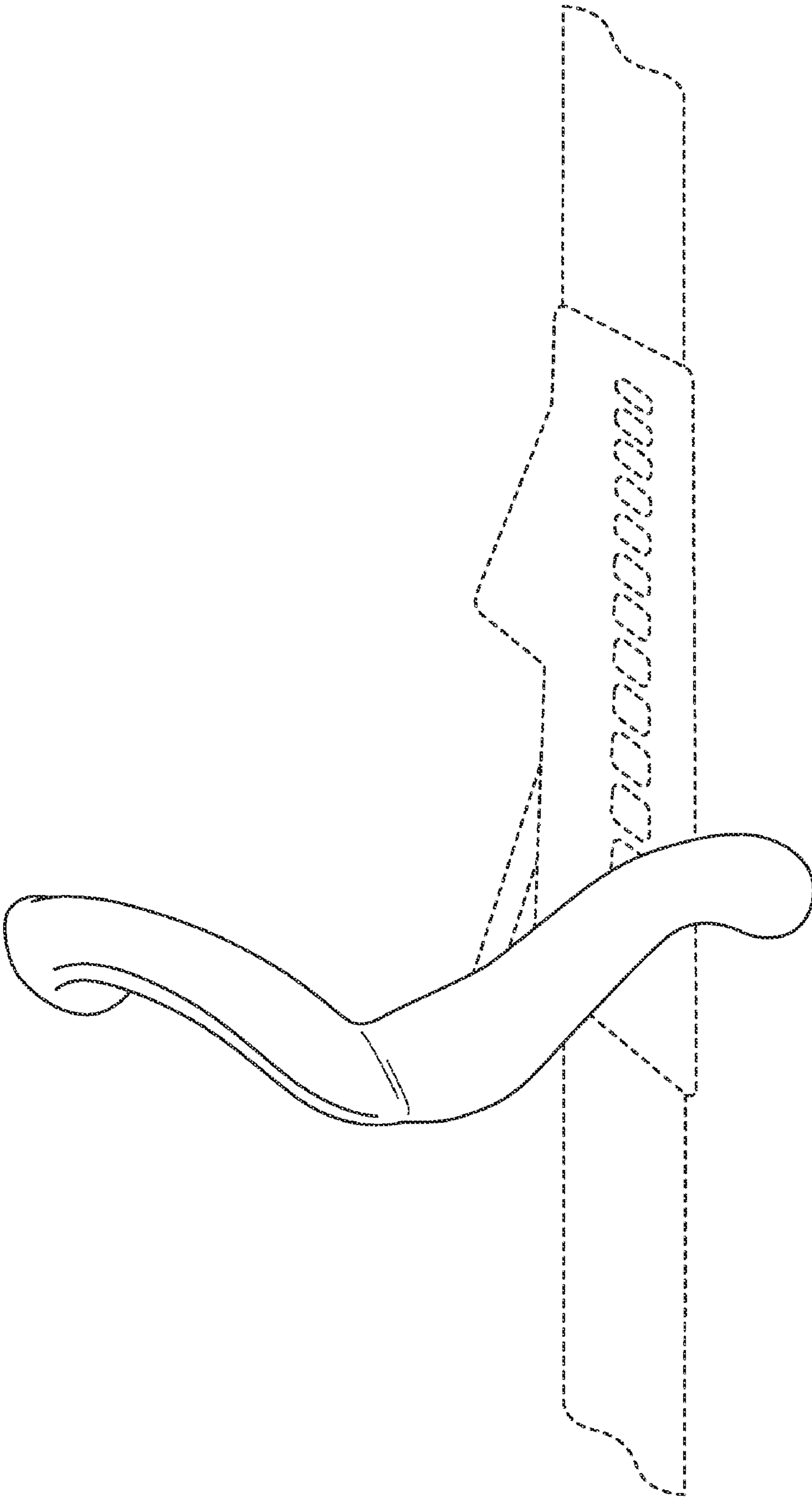

FIG. 5



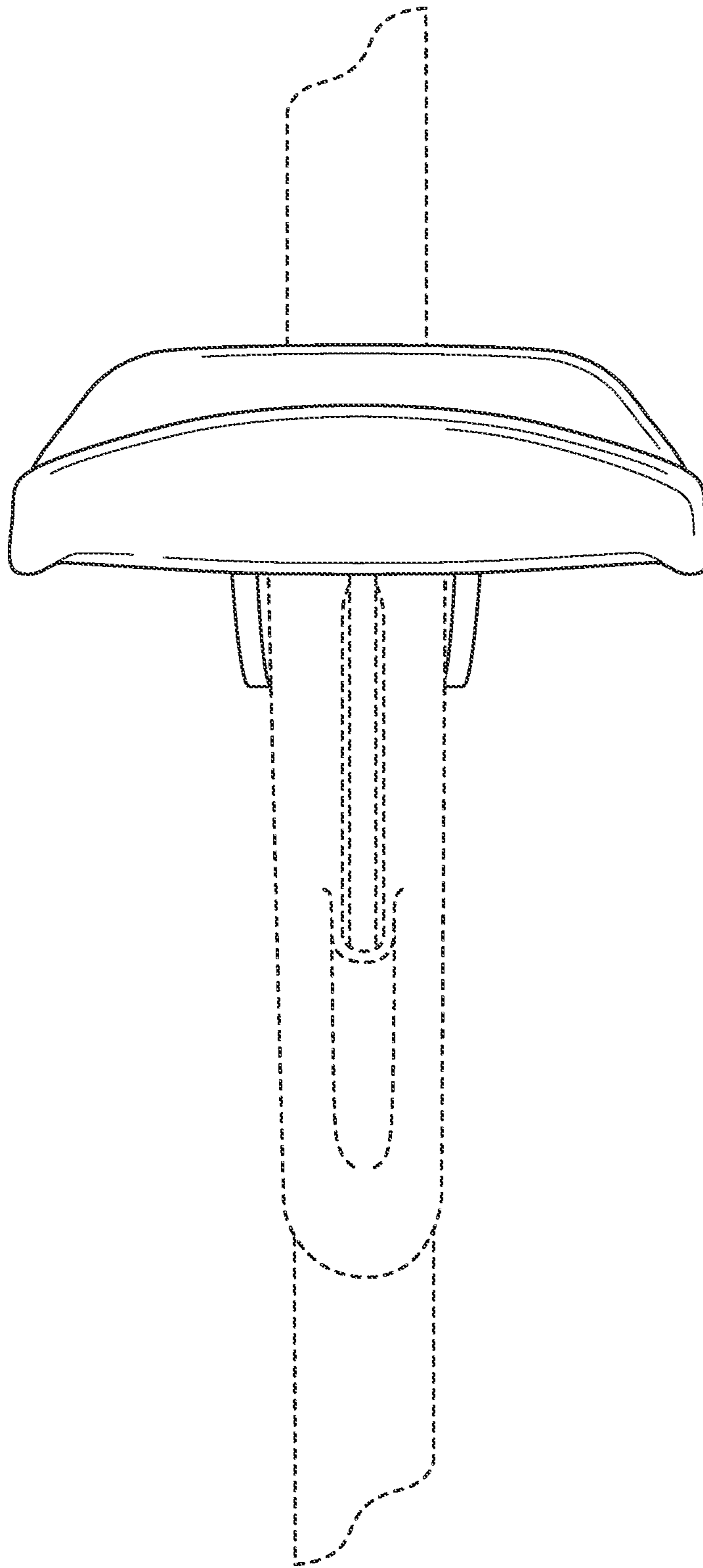

FIG. 6

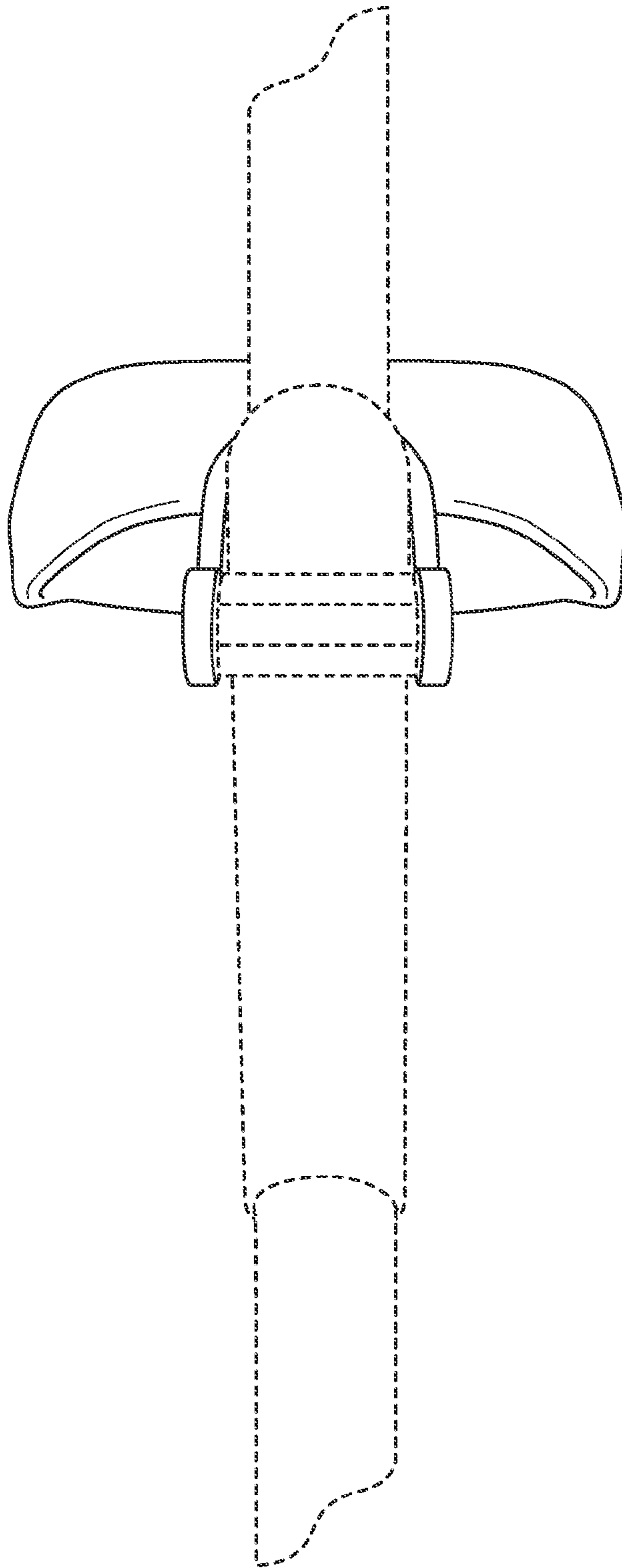

FIG. 7