



US00D586773S

(12) **United States Design Patent**
Kim et al.

(10) **Patent No.:** **US D586,773 S**

(45) **Date of Patent:** **** Feb. 17, 2009**

(54) **CELLULAR PHONE**

(75) Inventors: **Young-Se Kim**, Palo Alto, CA (US);
Ji-Eun Lee, Seoul (KR); **Young-Ju Yeo**,
Seoul (KR); **Chang-Soo Lee**, Incheon-si
(KR)

(73) Assignee: **Samsung Electronics Co., Ltd.**,
Suwon-Si (KR)

(**) Term: **14 Years**

(21) Appl. No.: **29/290,554**

(22) Filed: **Dec. 17, 2007**

(51) **LOC (9) Cl.** **14-03**

(52) **U.S. Cl.** **D14/138 AB**

(58) **Field of Classification Search** D14/138 AB,
D14/496, 341-347; 455/575.3

See application file for complete search history.

(56) **References Cited**

U.S. PATENT DOCUMENTS

D321,865	S	*	11/1991	Derocher	D14/345
5,742,912	A	*	4/1998	Nishiyama et al.	455/566
D423,000	S	*	4/2000	Prietsman et al.	D14/138 AB
6,396,924	B1	*	5/2002	Suso et al.	379/433.13
D476,303	S	*	6/2003	Lee et al.	D14/138 AB
D482,030	S	*	11/2003	Kataoka	D14/345
6,914,982	B2	*	7/2005	Toyoda et al.	379/433.13
D546,308	S	*	7/2007	Lee	D14/138 AB
D548,212	S	*	8/2007	Lee	D14/138 AB
D557,238	S	*	12/2007	Kim	D14/138 AD
D558,723	S	*	1/2008	Lee et al.	D14/138 AB
D559,812	S	*	1/2008	Bradford et al.	D14/138 AB
D567,781	S	*	4/2008	Hwang et al.	D14/138 AB
D568,279	S	*	5/2008	Kwon et al.	D14/138 AB
D572,221	S	*	7/2008	Yang et al.	D14/138
D572,222	S	*	7/2008	Choi et al.	D14/138
D572,228	S	*	7/2008	Kwon et al.	D14/138
D579,906	S	*	11/2008	Kim et al.	D14/138 R
D581,889	S	*	12/2008	Kim et al.	D14/138 AB

2006/0089181 A1* 4/2006 Gartrell 455/575.3

OTHER PUBLICATIONS

Samsung X520 telephone, announced Oct. 2006, [online], [site visited Dec. 6, 2008]. Available from Internet ,<URL: http://www.gsmarena.com>.*

Samsung Serene telephone, announced Oct. 2005, [online], [site visited Dec. 6, 2008]. Available from Internet ,<URL: http://www.gsmarena.com>.*

LG HB620T telephone, announced Feb. 2008, [online], [site visited Dec. 6, 2008]. Available from Internet ,<URL: http://www.gsmarena.com>.*

O2 Cocoon telephone, announced Jun. 2007, [online], [site visited Dec. 6, 2008]. Available from Internet ,<URL: http://www.gsmarena.com>.*

Sony Ericsson W380 telephone, announced Nov. 2007, [online], [site visited Dec. 6, 2008]. Available from Internet ,<URL: http://www.gsmarena.com>.*

* cited by examiner

Primary Examiner—Jeffrey D Asch

(74) *Attorney, Agent, or Firm*—Staas & Halsey LLP

(57) **CLAIM**

The ornamental design for a cellular phone, as shown and described.

DESCRIPTION

FIG. 1 is a perspective view of a cellular phone according to our new design;

FIG. 2 is a front elevational view thereof;

FIG. 3 is a rear elevational view thereof;

FIG. 4 is a left side elevational view thereof;

FIG. 5 is a right side elevational view thereof;

FIG. 6 is a top plan view thereof;

FIG. 7 is a bottom plan view thereof; and,

FIG. 8 is a perspective view of the cellular phone according to our new design in a state in which the cellular phone is open when used.

1 Claim, 6 Drawing Sheets

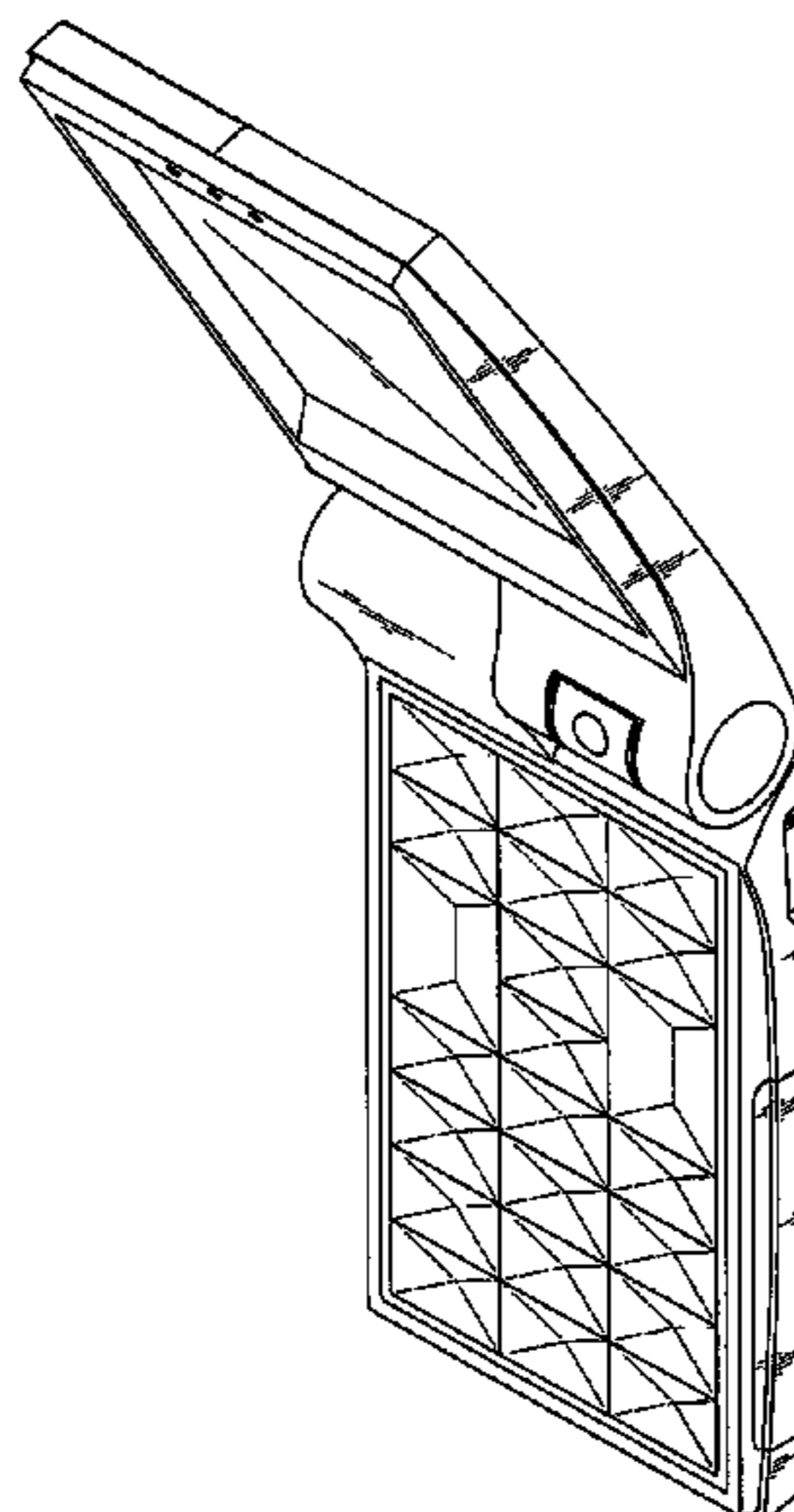
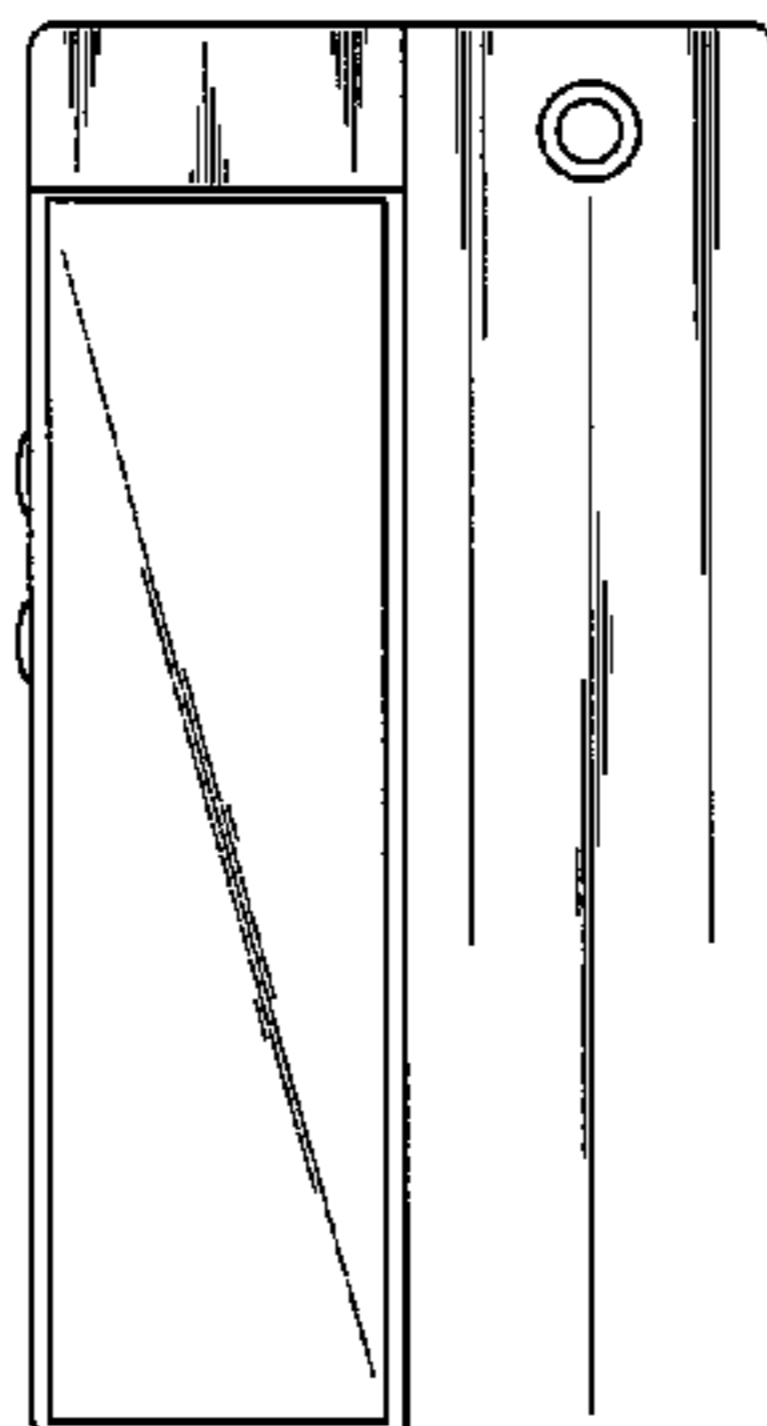

FIG. 1



FIG. 2

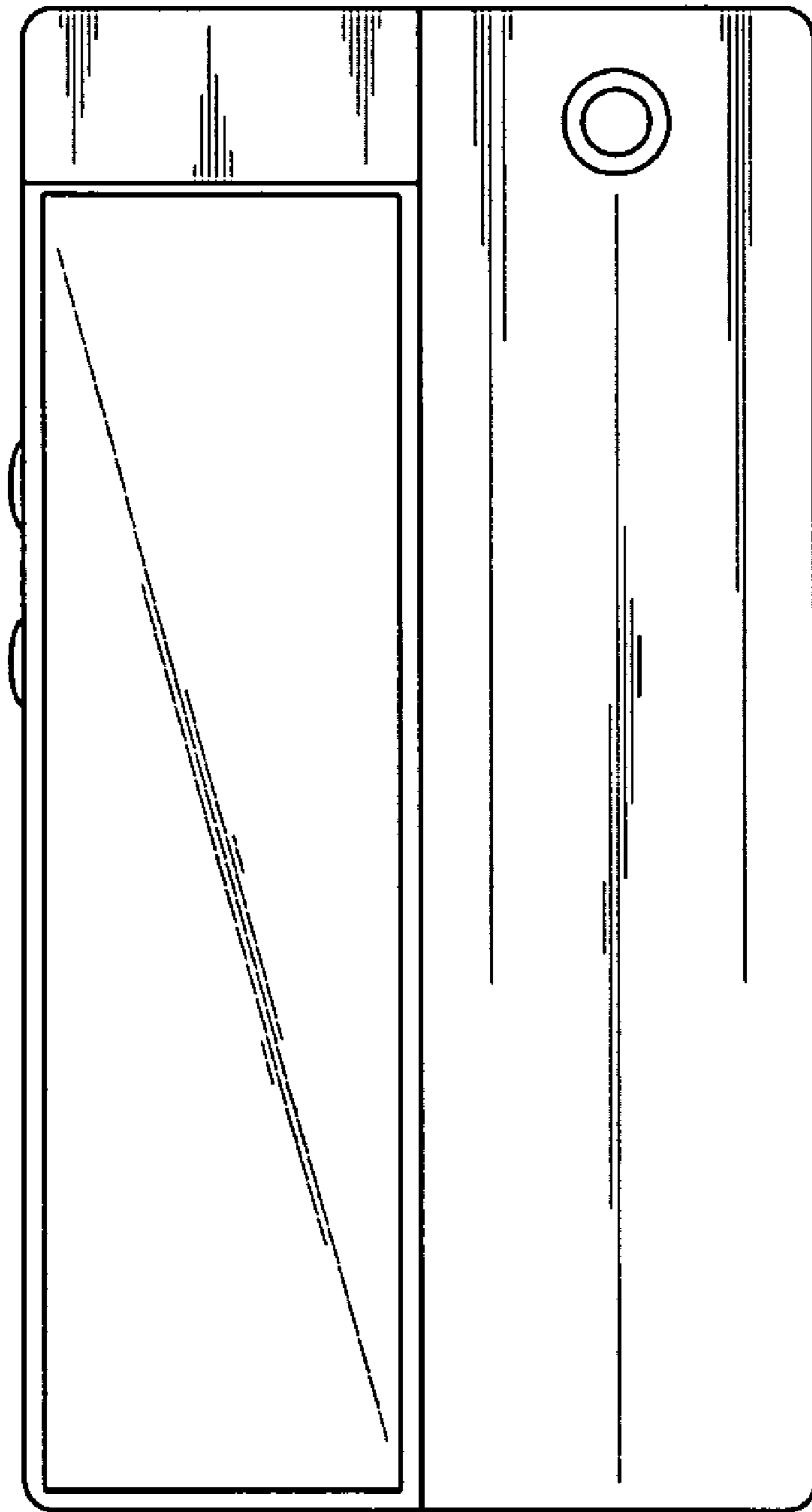

FIG. 3

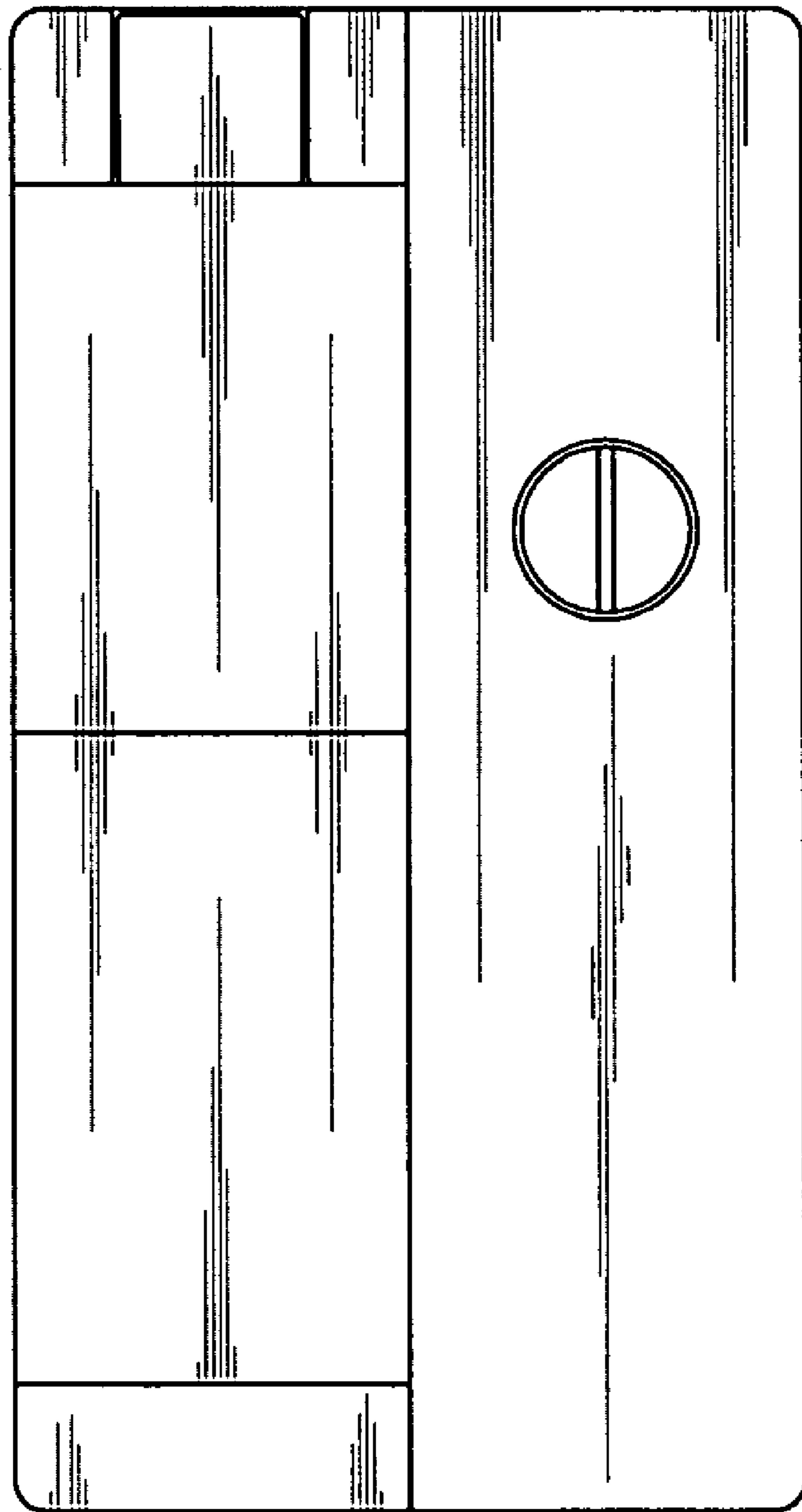

FIG. 4

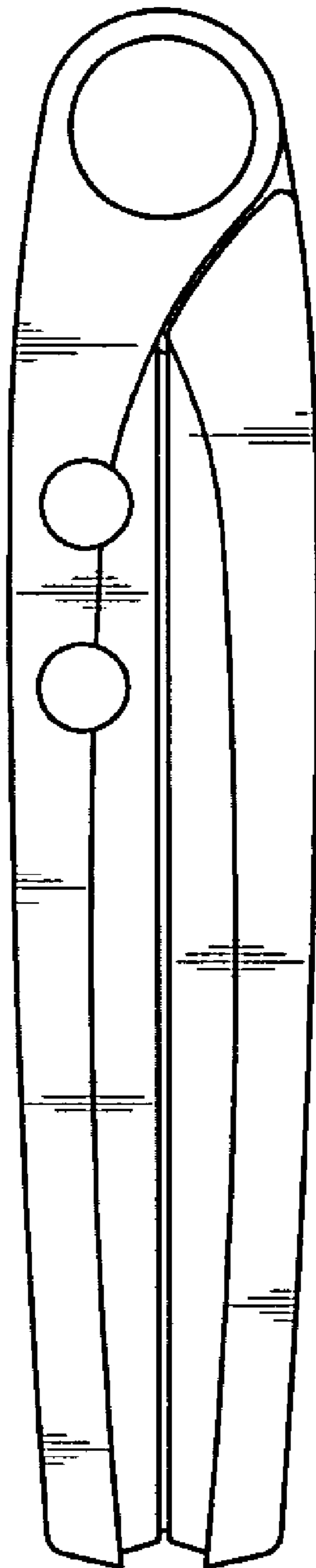

FIG. 5

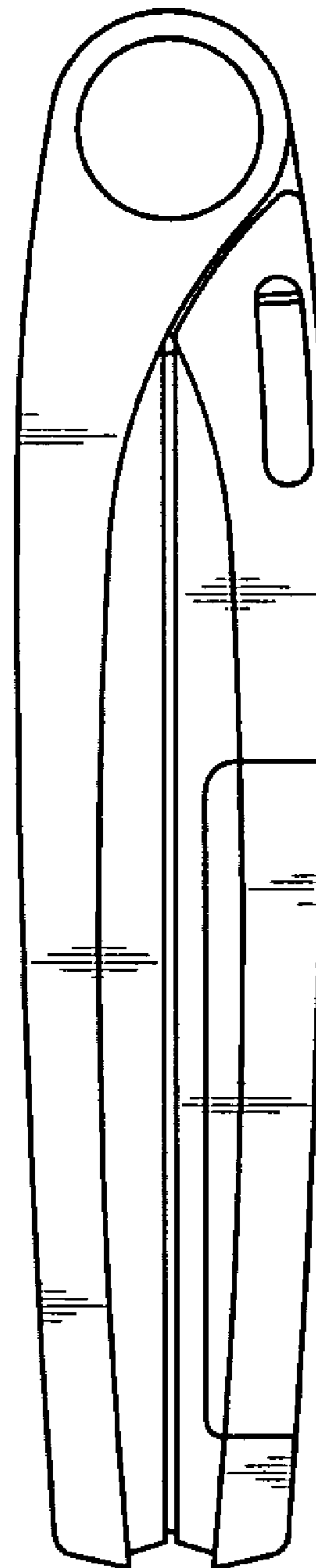

FIG. 6

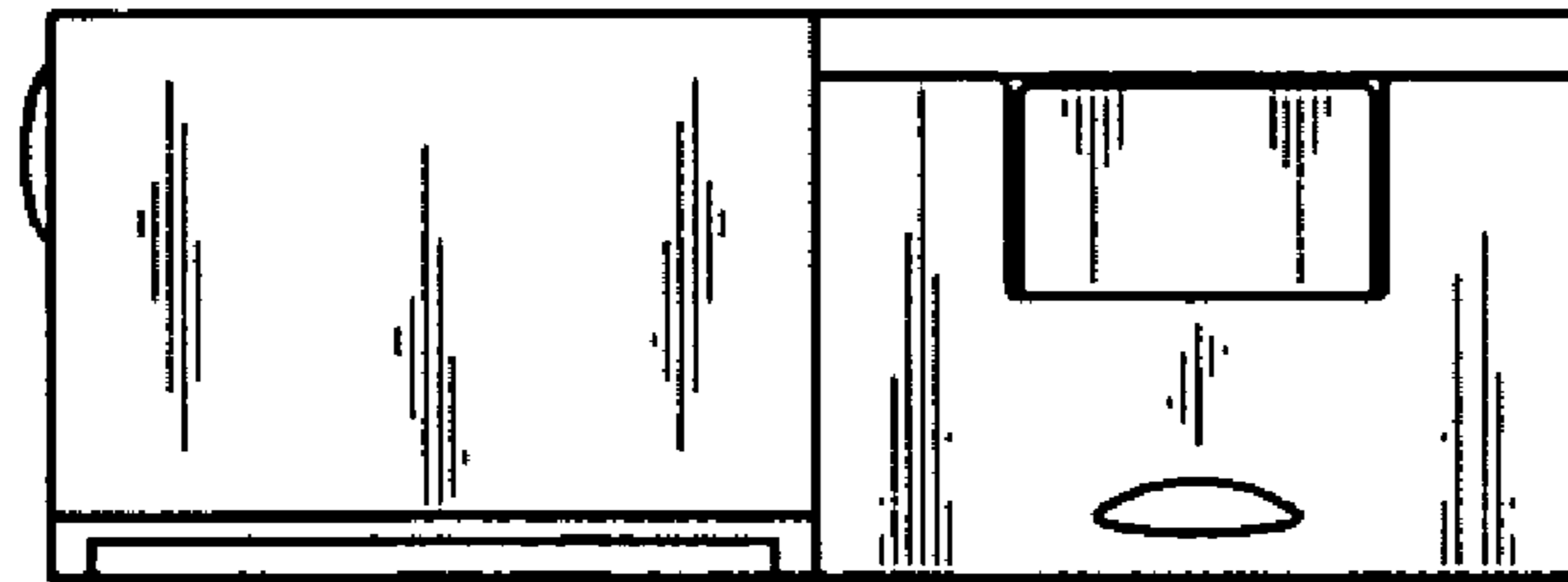

FIG. 7

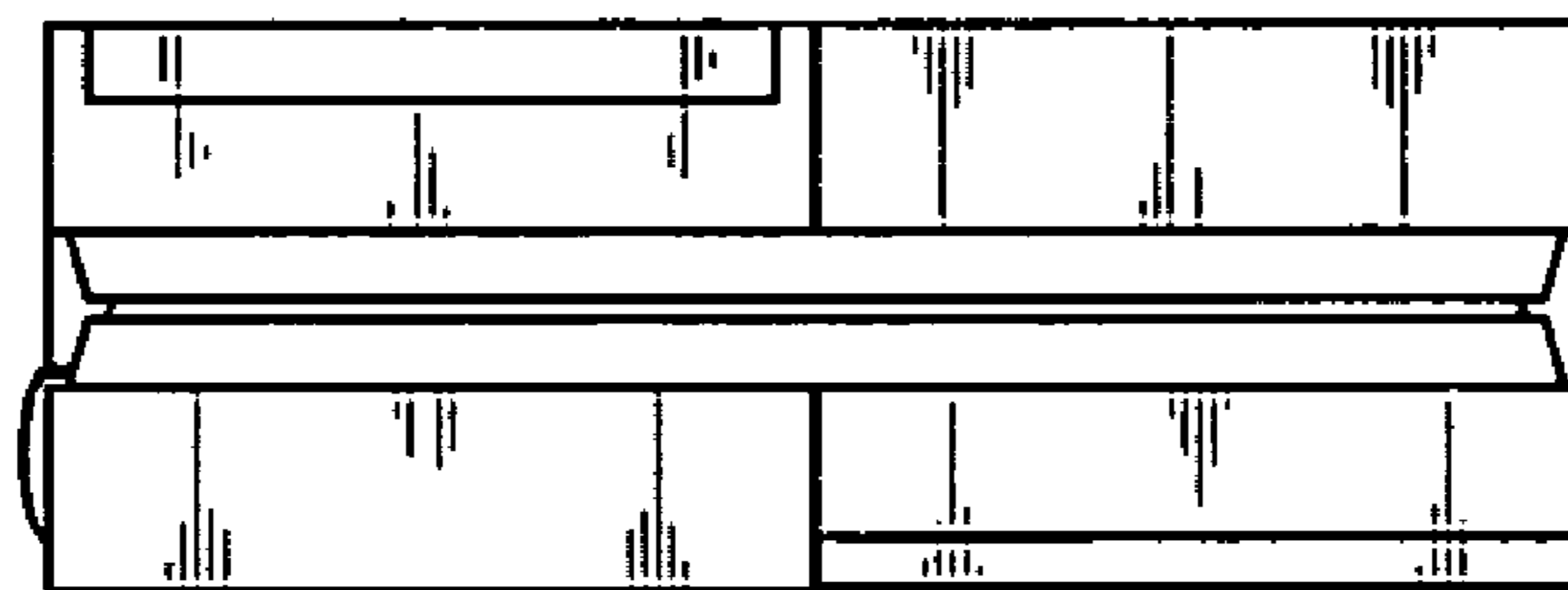

FIG. 8

