



US00D586675S

(12) **United States Design Patent**  
**Wagner et al.**

(10) **Patent No.:** **US D586,675 S**

(45) **Date of Patent:** **\*\* Feb. 17, 2009**

(54) **MEASURING TAPE**

(75) Inventors: **Wolfgang Wagner**, Hamburg (DE);  
**Sabine Schober**, Hamburg (DE)

(73) Assignee: **Seca AG**, Reinbach (CH)

(\*\*) Term: **14 Years**

(21) Appl. No.: **29/300,565**

(22) Filed: **Apr. 10, 2008**

(30) **Foreign Application Priority Data**

Nov. 13, 2007 (EM) ..... 000825666

(51) **LOC (9) Cl.** ..... **10-04**

(52) **U.S. Cl.** ..... **D10/72**

(58) **Field of Classification Search** ..... D10/72;  
33/755-771; 242/292, 381.1-381.6

See application file for complete search history.

(56) **References Cited**

**U.S. PATENT DOCUMENTS**

3,316,361 A \* 4/1967 Thompson ..... 242/381.6

4,786,010 A \* 11/1988 Dynan ..... D10/72

D428,922 S \* 8/2000 Packard et al. .... D10/72

\* cited by examiner

*Primary Examiner*—Antoine D Davis

(74) *Attorney, Agent, or Firm*—Nixon & Vanderhye, P.C.

(57) **CLAIM**

The ornamental design for a “measuring tape,” as shown and described.

**DESCRIPTION**

FIG. 1 is a top perspective view of a measuring tape in accordance with our new design;

FIG. 2 is a bottom perspective view thereof;

FIG. 3 is a right side elevation view thereof;

FIG. 4 is a top plan view thereof;

FIG. 5 is a bottom plan view thereof;

FIG. 6 is a left side view thereof;

FIG. 7 is a front elevation view thereof;

FIG. 8 is a rear elevation view thereof;

FIG. 9 is a perspective view similar to FIG. 1 but with the measuring tape extended;

FIG. 10 is a bottom perspective view with the measuring tape extended;

FIG. 11 is a right side elevation view with the measuring tape extended;

FIG. 12 is a top plan view with the measuring tape extended;

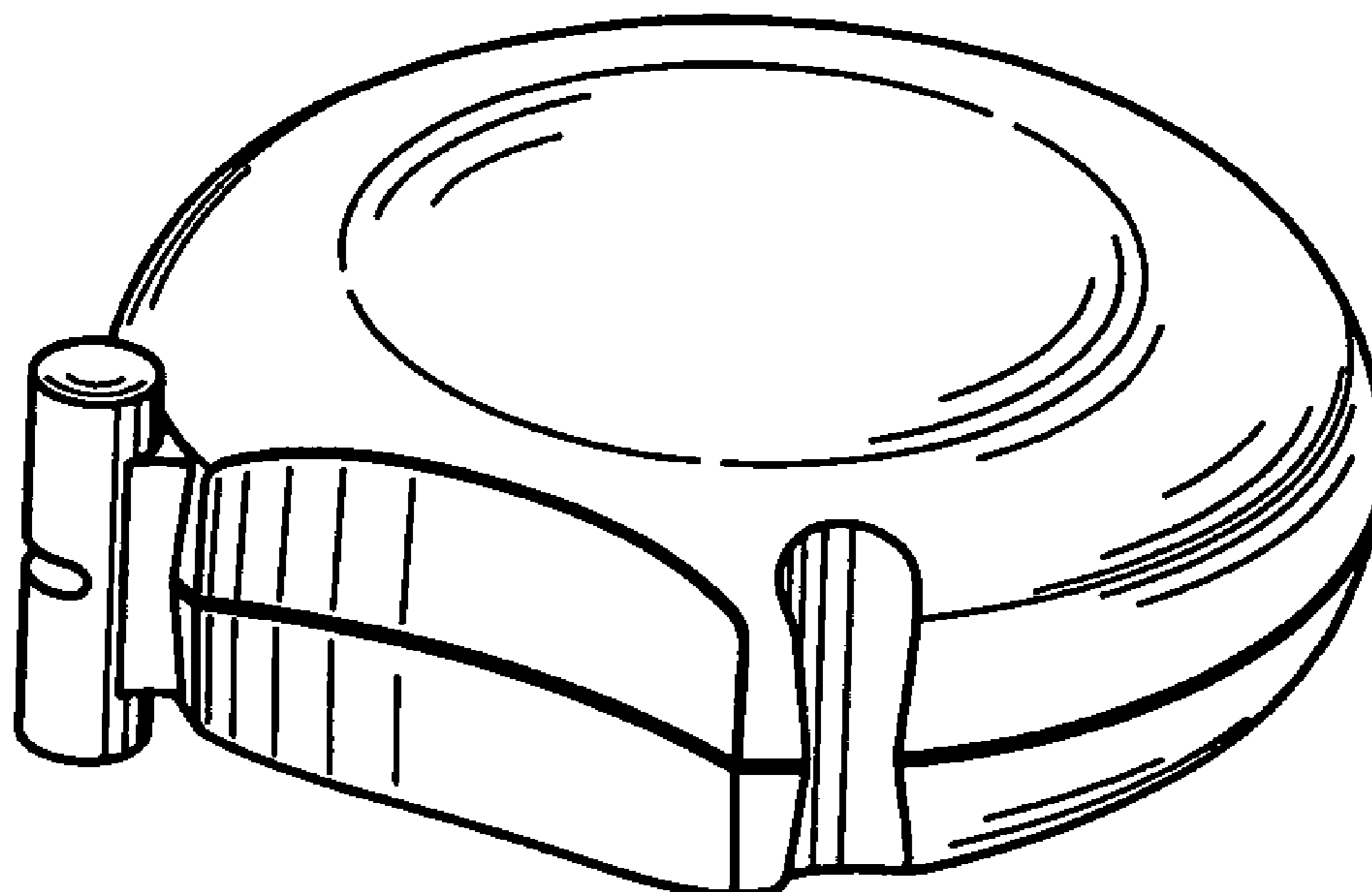
FIG. 13 is a bottom plan view with the measuring tape extended;

FIG. 14 is a left side elevation view with the measuring tape extended;

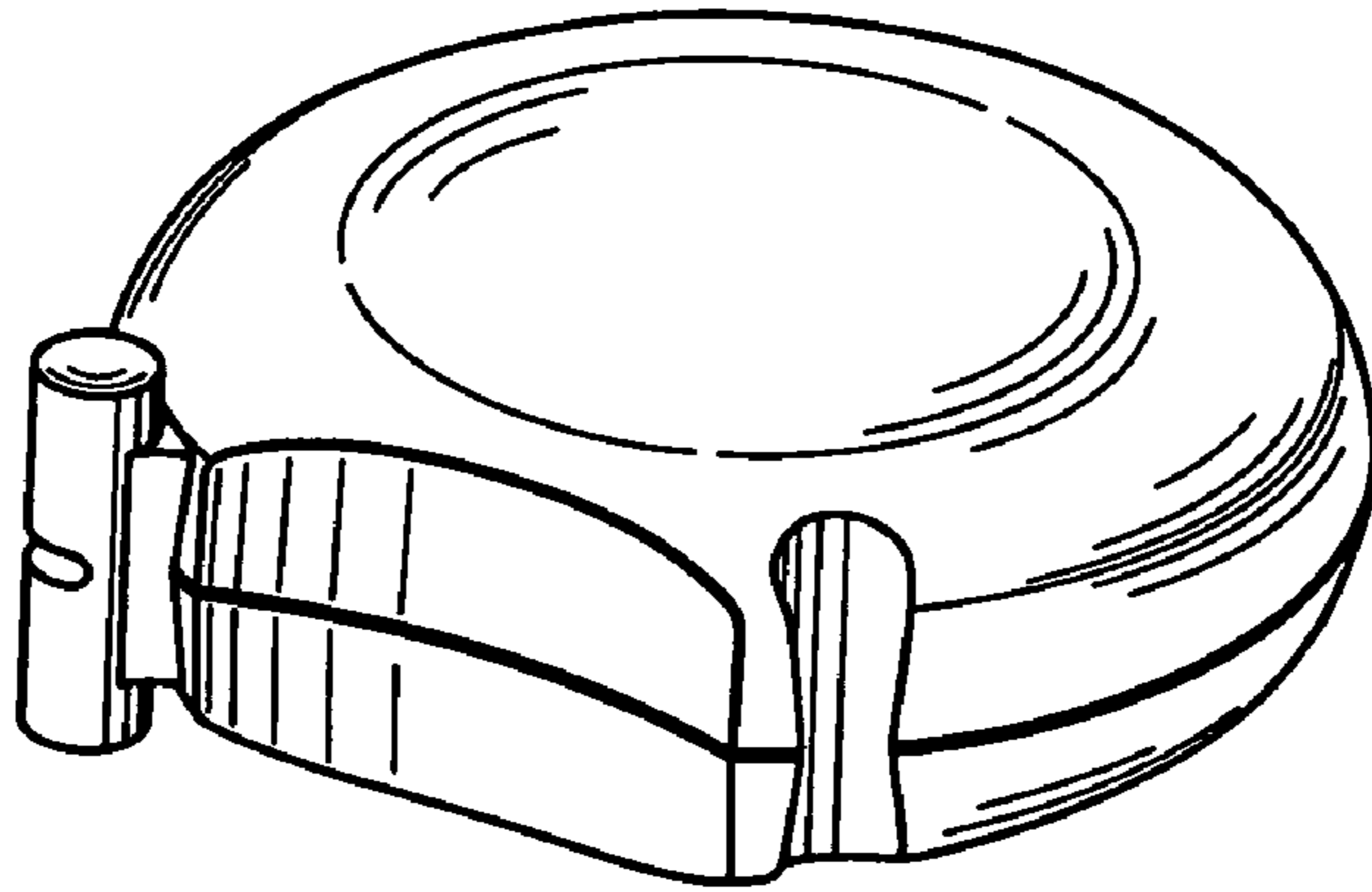
FIG. 15 is a front elevation view with the measuring tape extended; and,

FIG. 16 is a rear elevation view with the measuring tape extended.

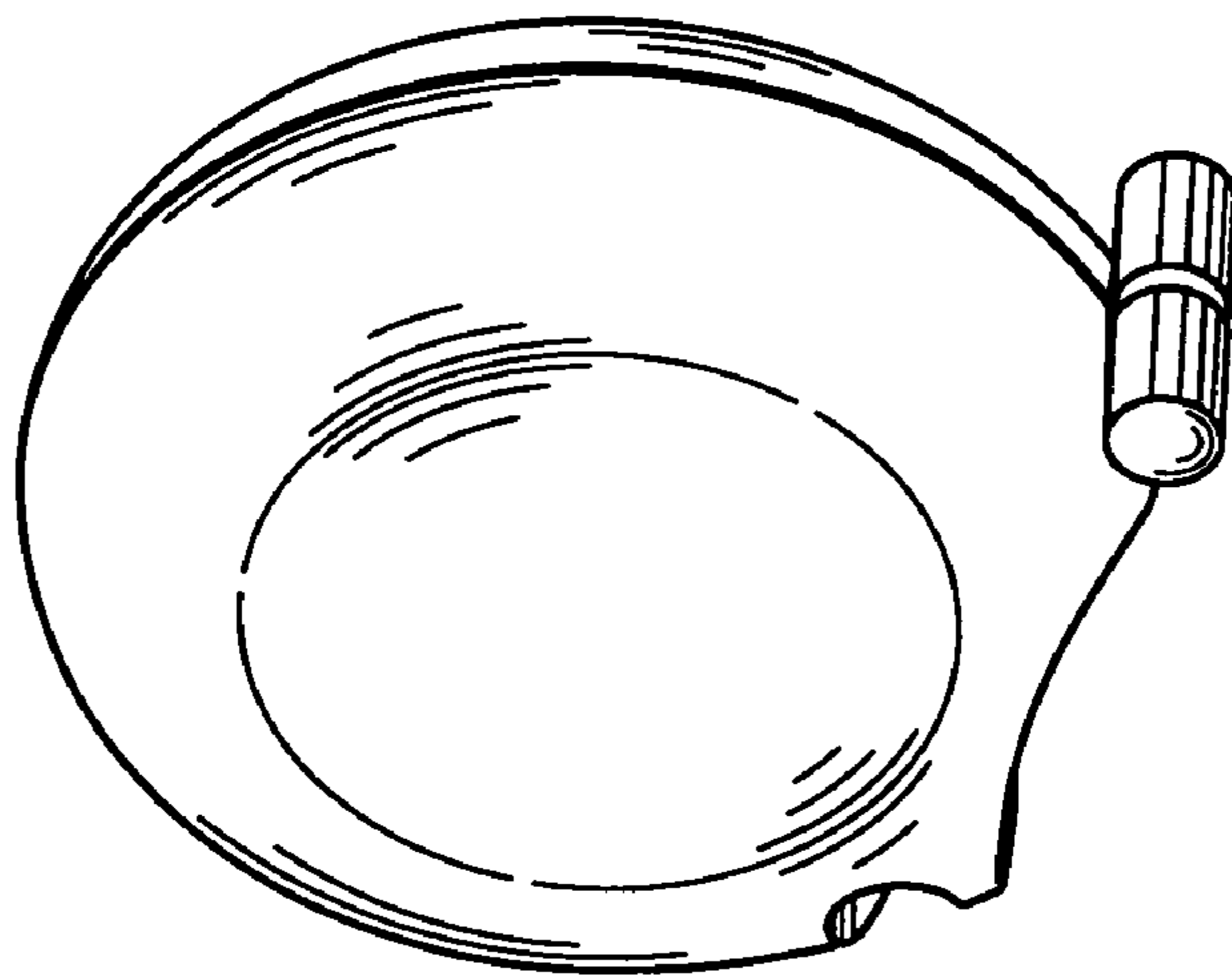
**1 Claim, 8 Drawing Sheets**



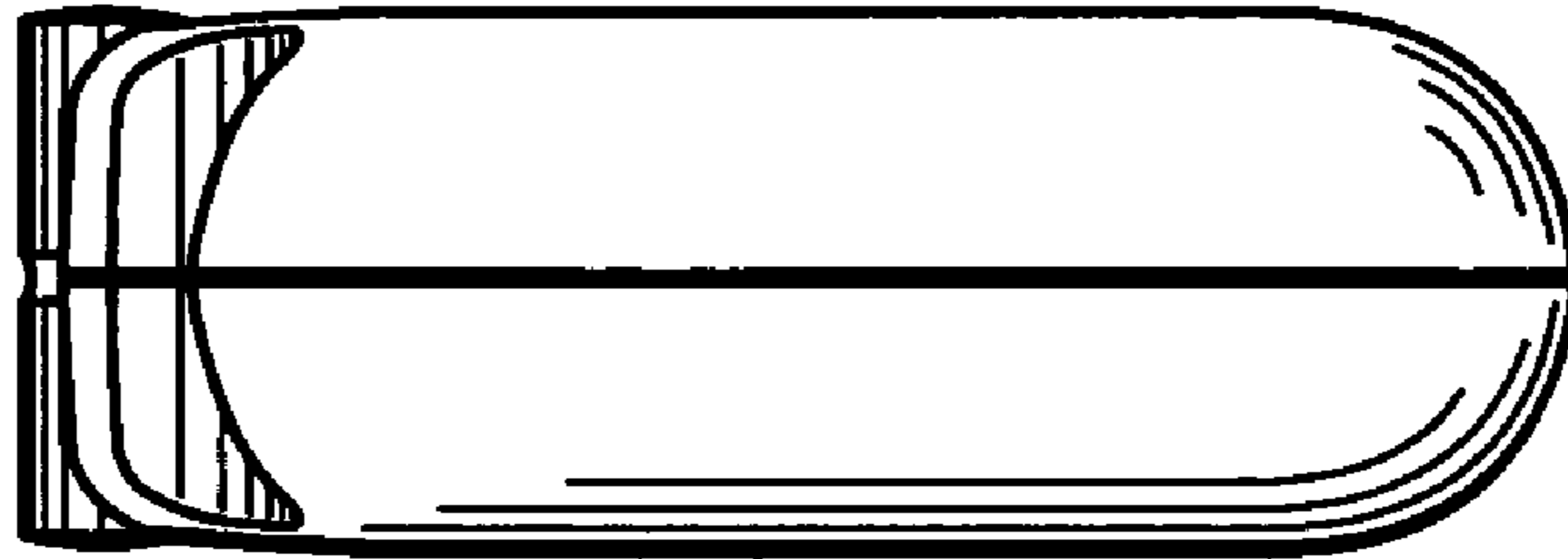
***Fig. 1***



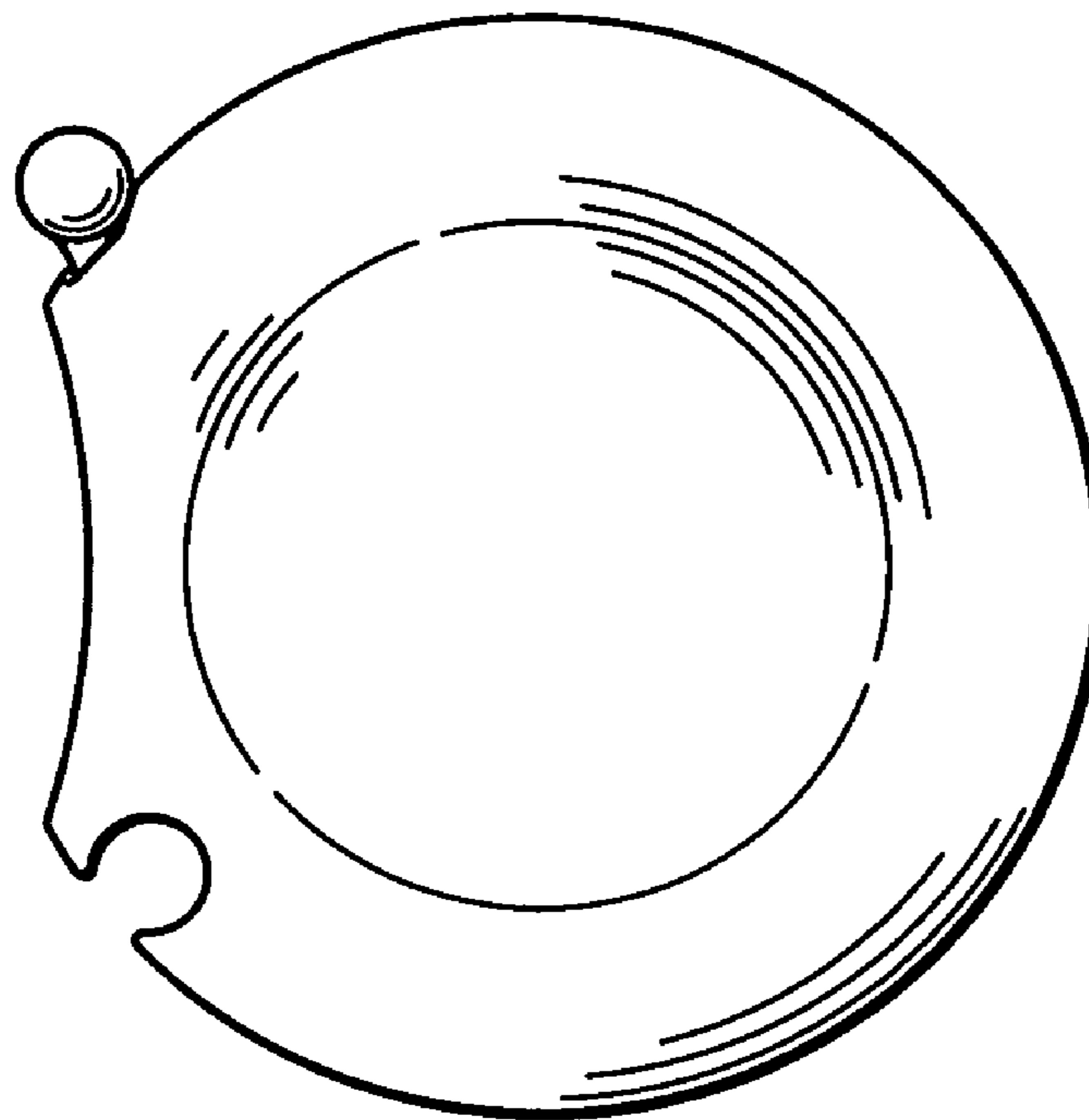
***Fig. 2***



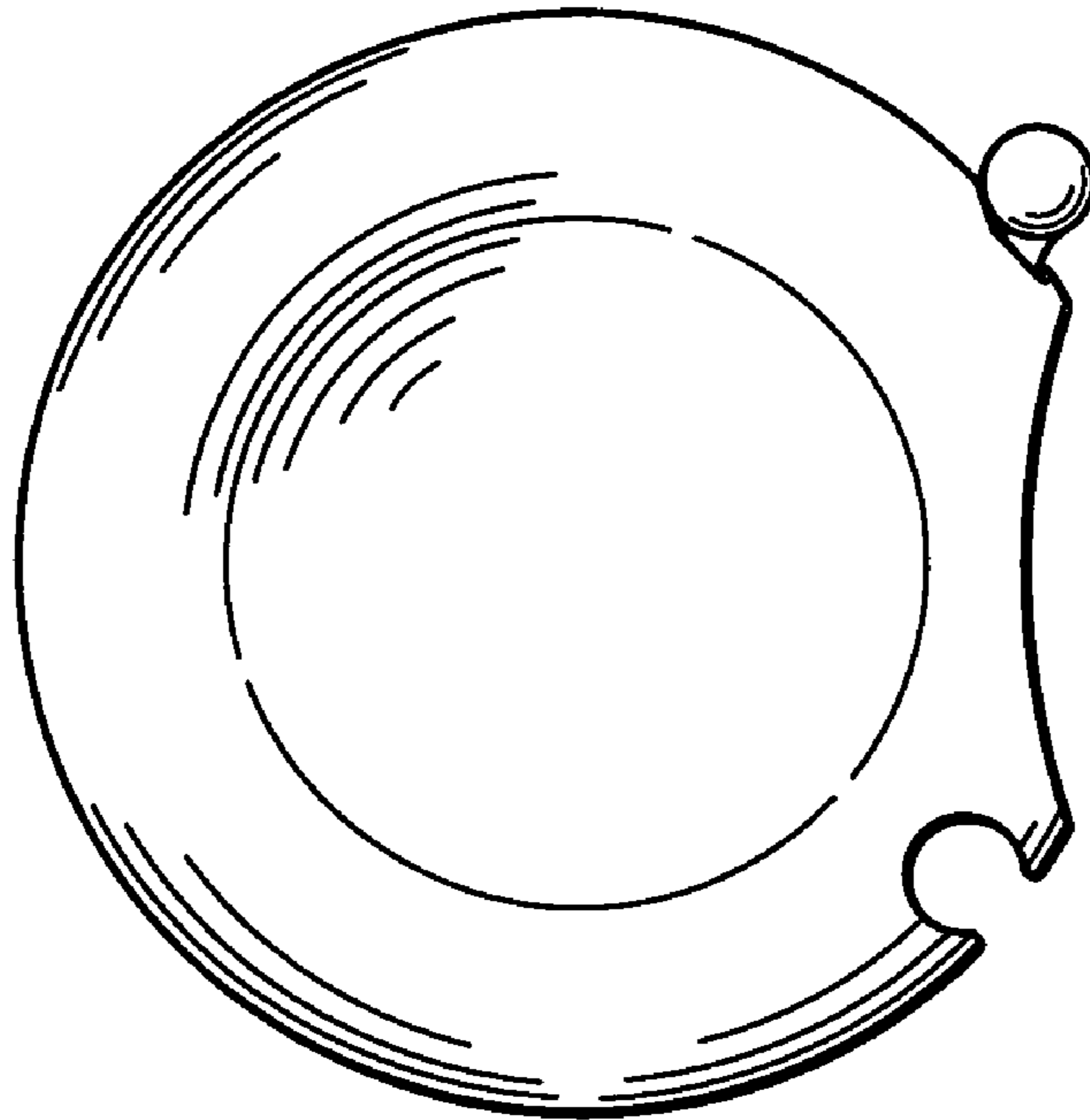
***Fig. 3***



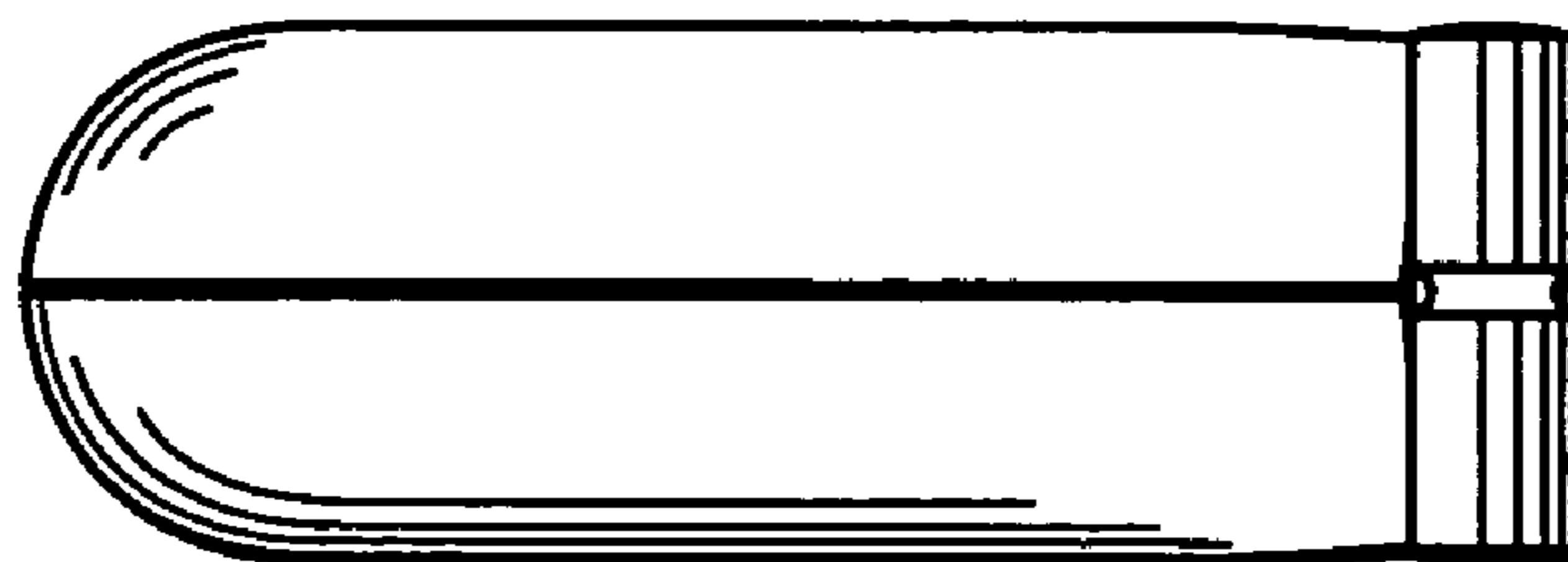
***Fig. 4***



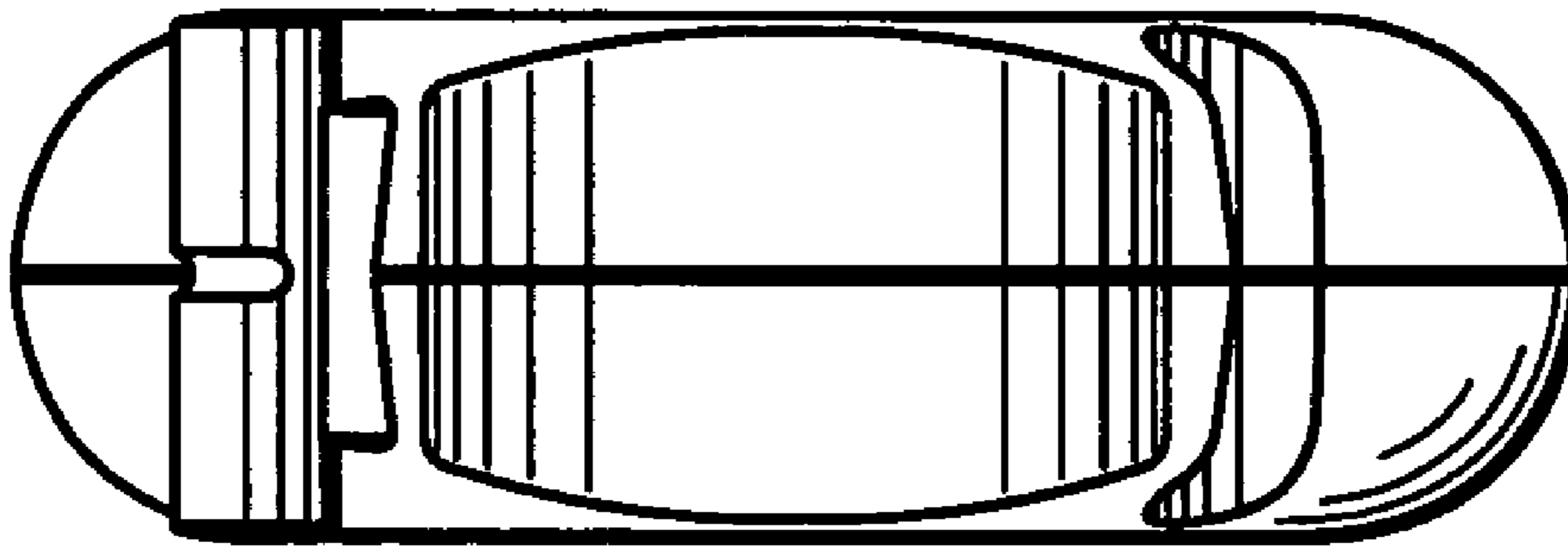
***Fig. 5***



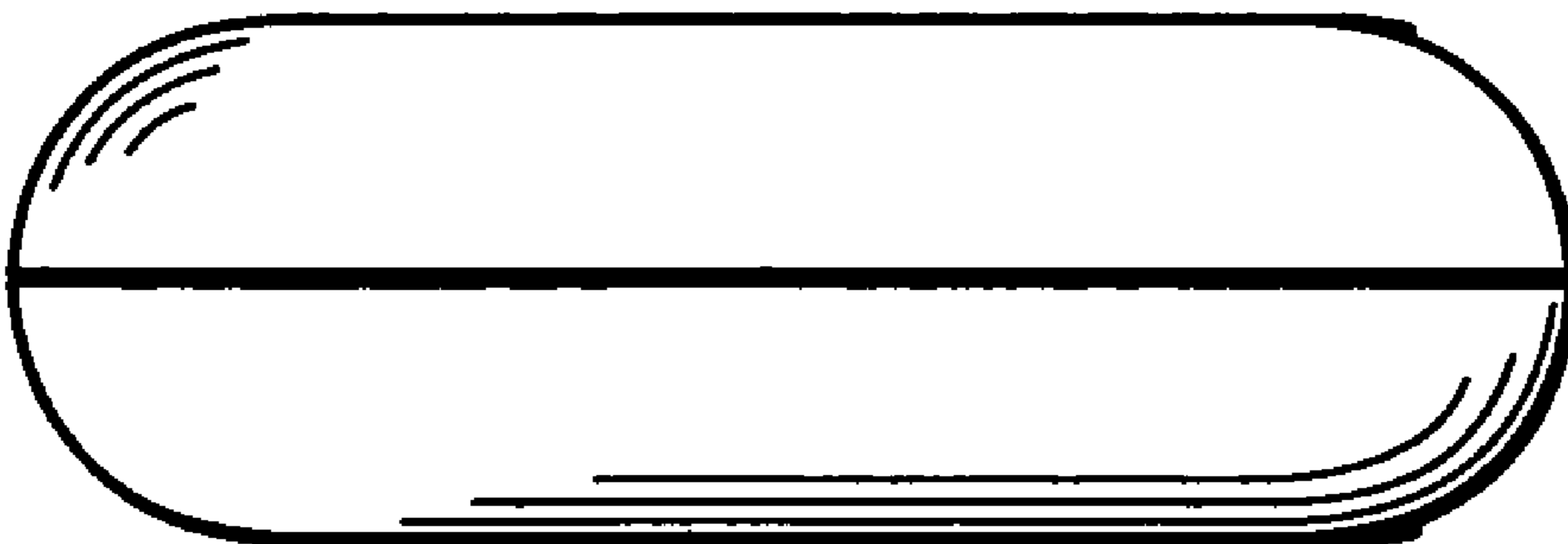
***Fig. 6***



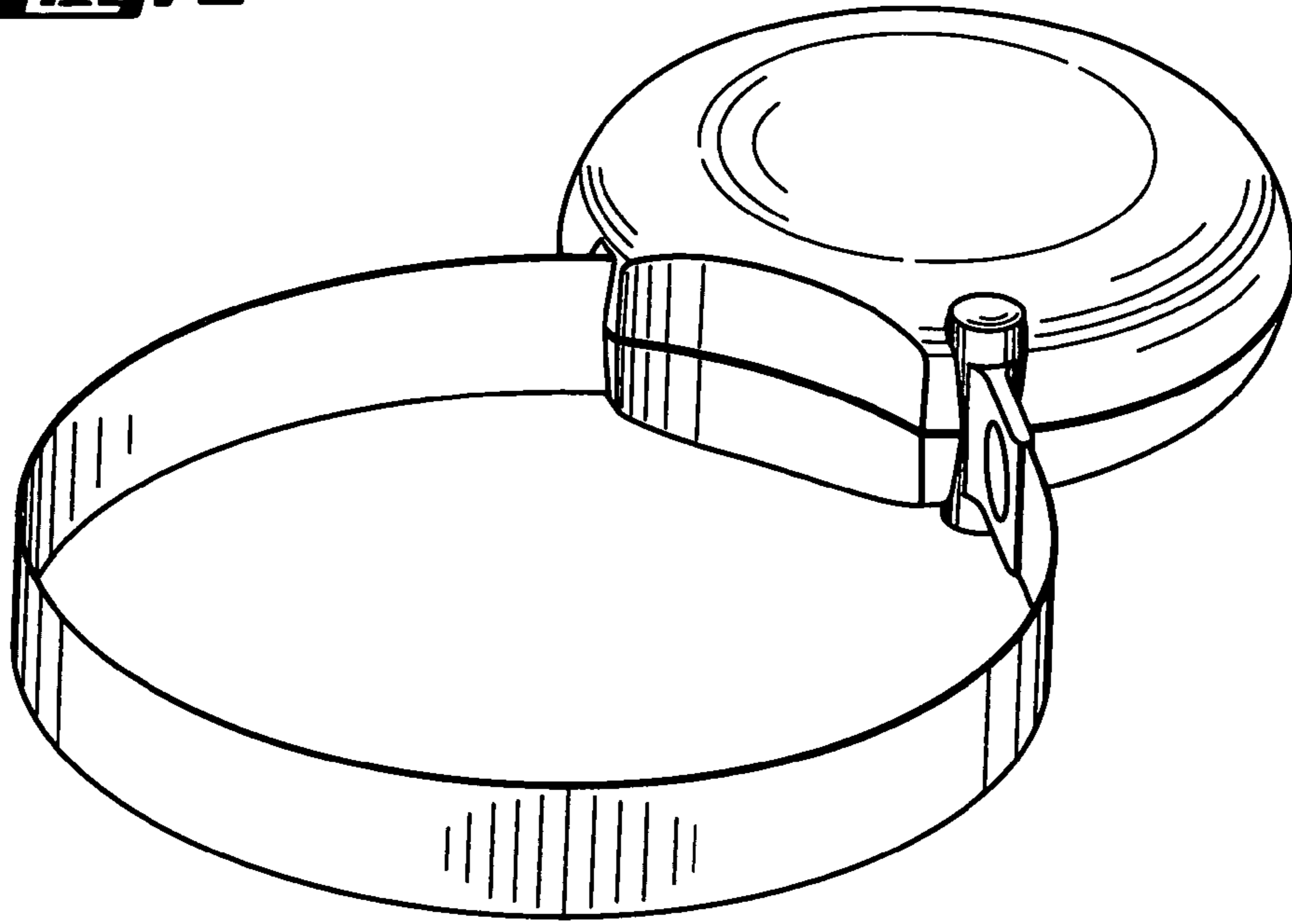
***Fig. 7***



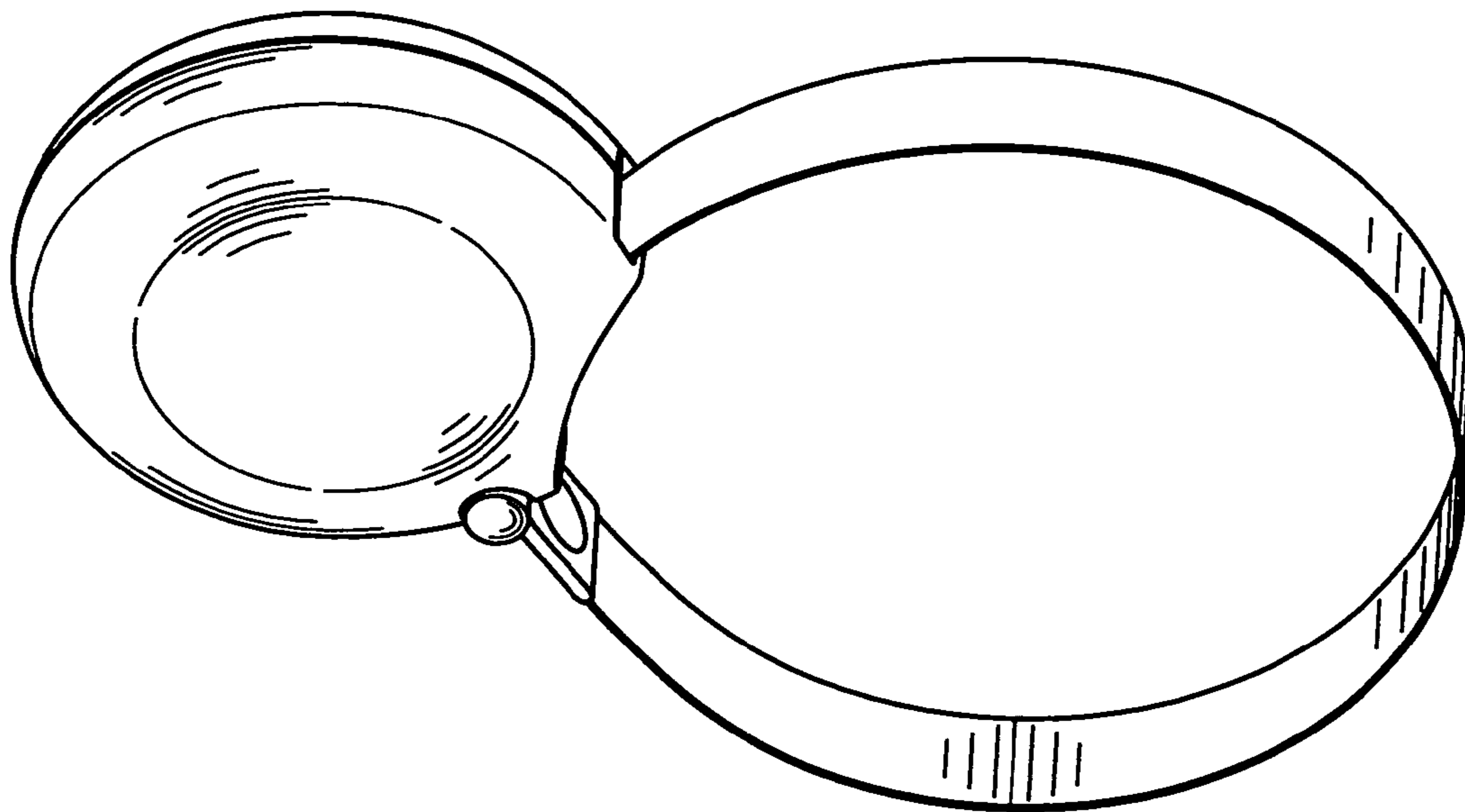
***Fig. 8***



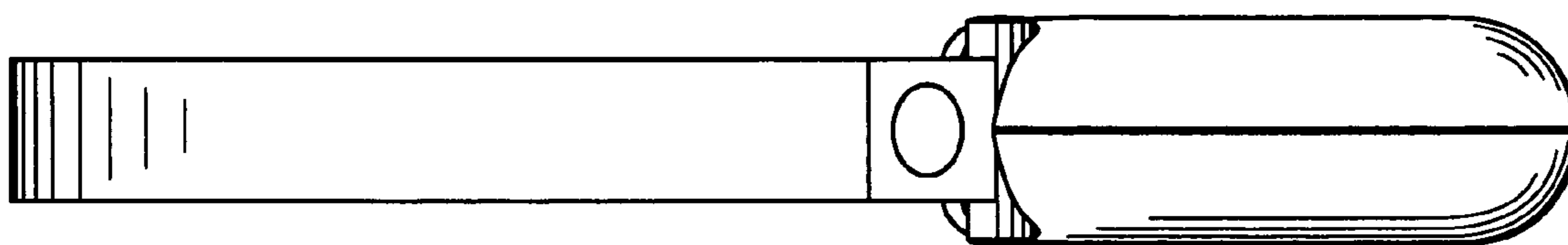
***Fig. 9***



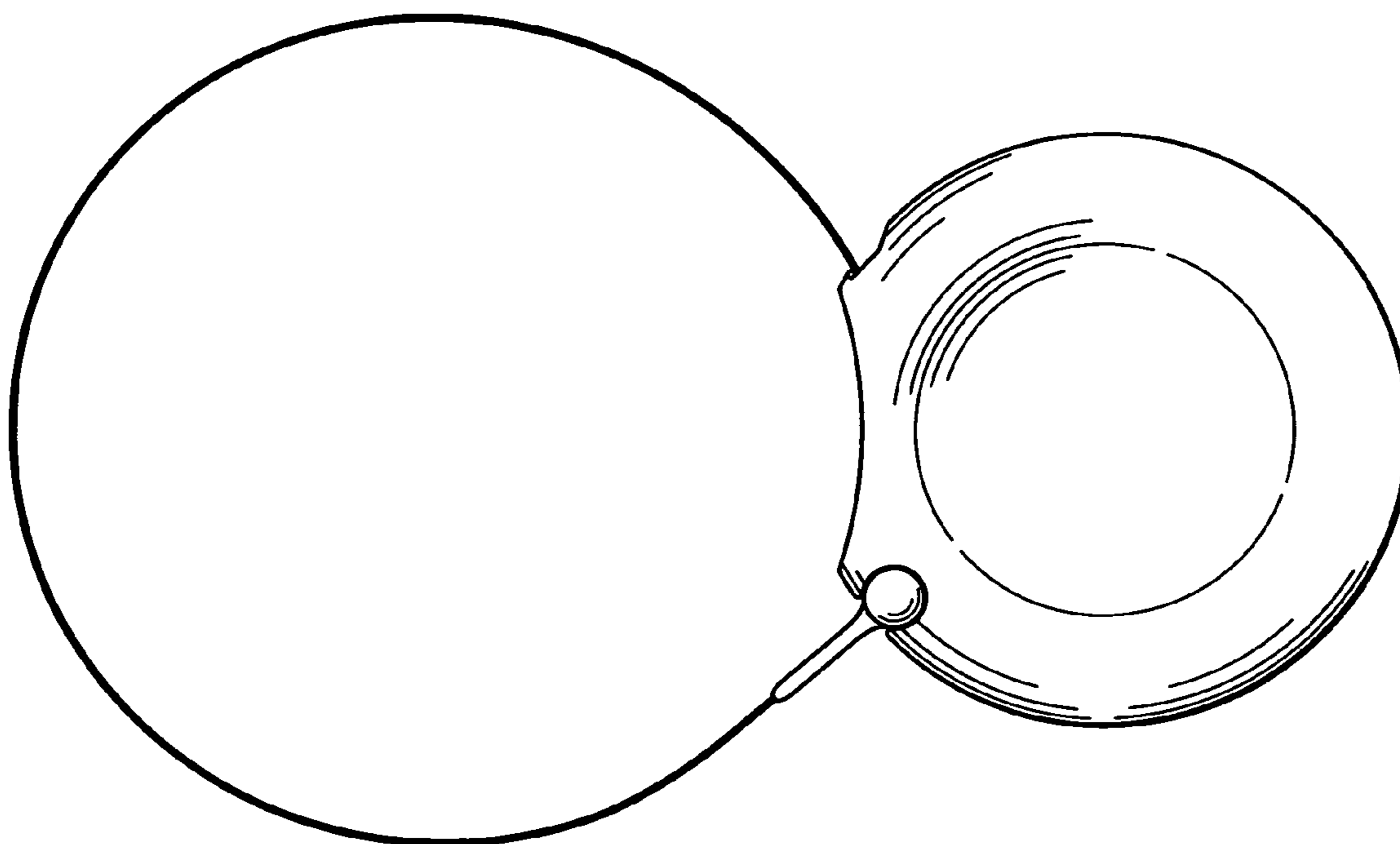
***Fig. 10***



***Fig. 11***

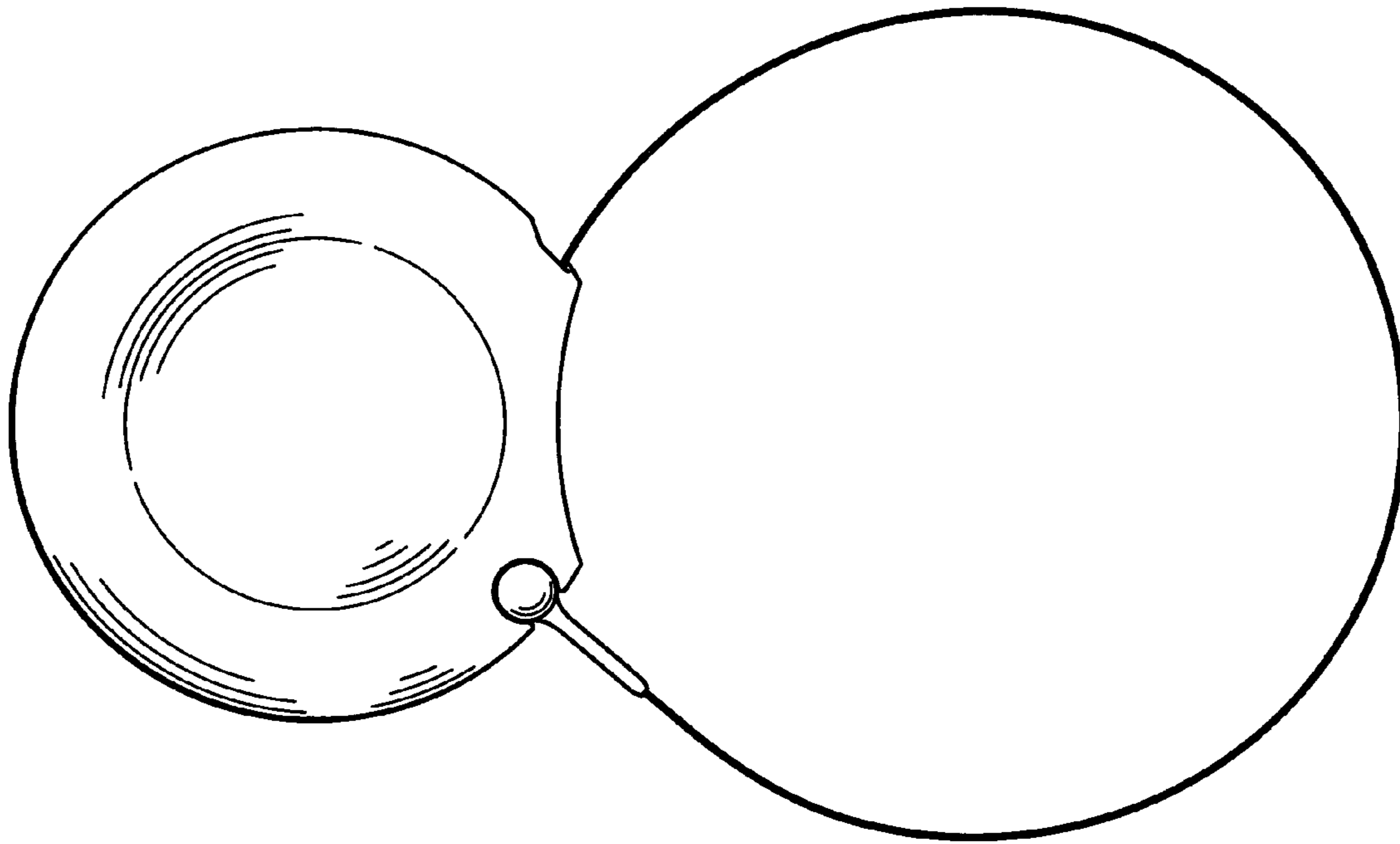


***Fig. 12***

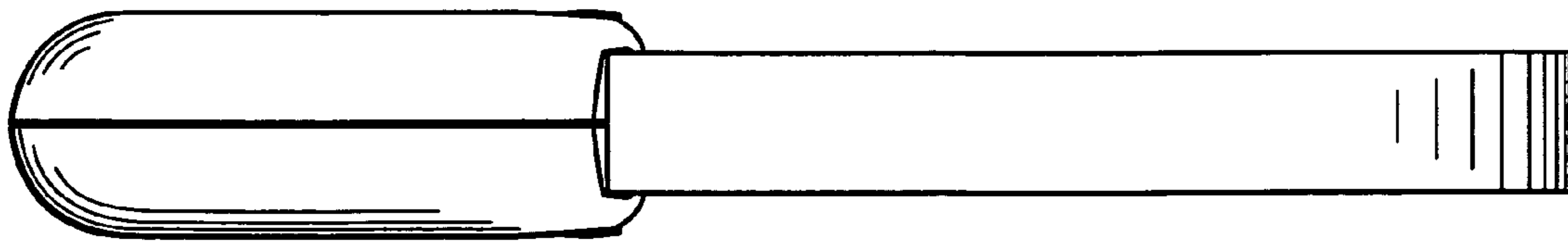




***Fig. 13***

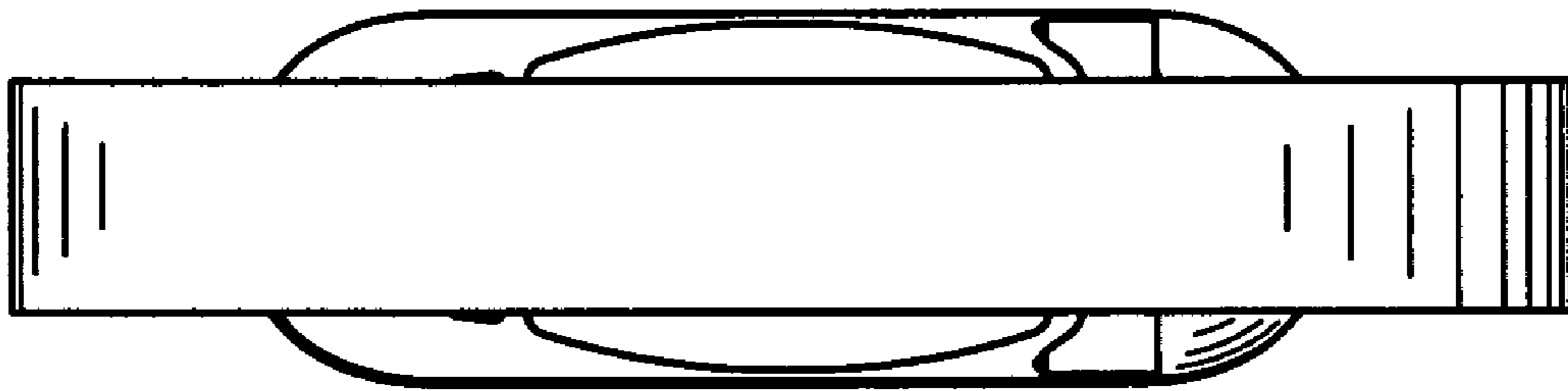


***Fig. 14***





***Fig. 15***



***Fig. 16***

