



US00D586674S

(12) **United States Design Patent**
Solarewicz

(10) **Patent No.:** **US D586,674 S**
(45) **Date of Patent:** **** Feb. 17, 2009**

(54) **PEDOMETER**

(75) Inventor: **Konrad Solarewicz**, Tokyo (JP)

(73) Assignee: **Tanita Corporation**, Tokyo (JP)

(**) Term: **14 Years**

(21) Appl. No.: **29/318,348**

(22) Filed: **May 19, 2008**

(30) **Foreign Application Priority Data**

Dec. 19, 2007 (JP) 2007-34829

(51) **LOC (9) Cl.** **10-04**

(52) **U.S. Cl.** **D10/70; D10/32; D10/38**

(58) **Field of Classification Search** D10/70,
D10/30-32, 38; 235/105; 377/5, 24.2, 26;
73/514.33, 514.34; 702/155, 160, 176, 78,
702/79, 82, 91, 92-95, 104, 116, 141, 150,
702/151, 154; 324/522; 224/164-168; 368/10,
368/21, 28-30, 223, 228, 232, 234, 239-242,
368/276, 277, 280-283, 285, 294, 295, 308,
368/319-321

See application file for complete search history.

(56) **References Cited**

U.S. PATENT DOCUMENTS

D400,112 S * 10/1998 Rider D10/70
D538,687 S * 3/2007 Komulainen D10/70

7,263,461 B2 * 8/2007 Sugai 702/150
7,333,914 B1 * 2/2008 Iachini 702/160
7,376,533 B2 * 5/2008 Fujiwara 702/160
D573,899 S * 7/2008 Kuchler D10/32

* cited by examiner

Primary Examiner—Antoine D Davis

(74) *Attorney, Agent, or Firm*—Frishaufm, Holtz, Goodman & Chick, P.C.

(57) **CLAIM**

The ornamental design for a pedometer, as shown and described.

DESCRIPTION

FIG. 1 is a front, right side, bottom perspective view of a pedometer showing my new design;

FIG. 2 is a front elevational view thereof;

FIG. 3 is a rear elevational view thereof;

FIG. 4 is a left side view thereof;

FIG. 5 is a right side view thereof;

FIG. 6 is a top plan view thereof;

FIG. 7 is a bottom plan view thereof; and,

FIG. 8 is a reference front elevational view thereof showing a state in which this article is electrified.

The portions in broken lines are shown for illustrative purposes only and form no part of the claimed design.

1 Claim, 8 Drawing Sheets

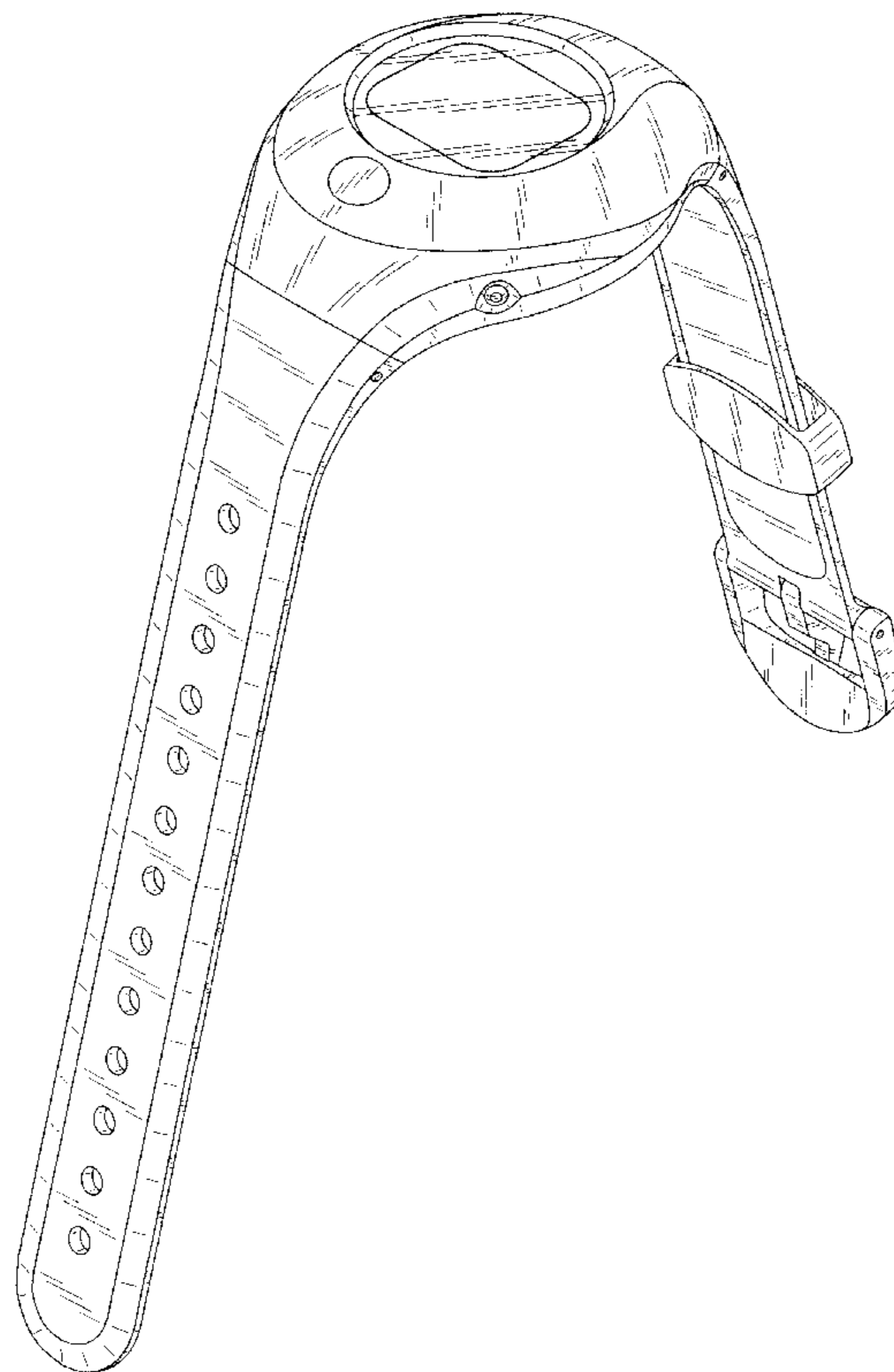

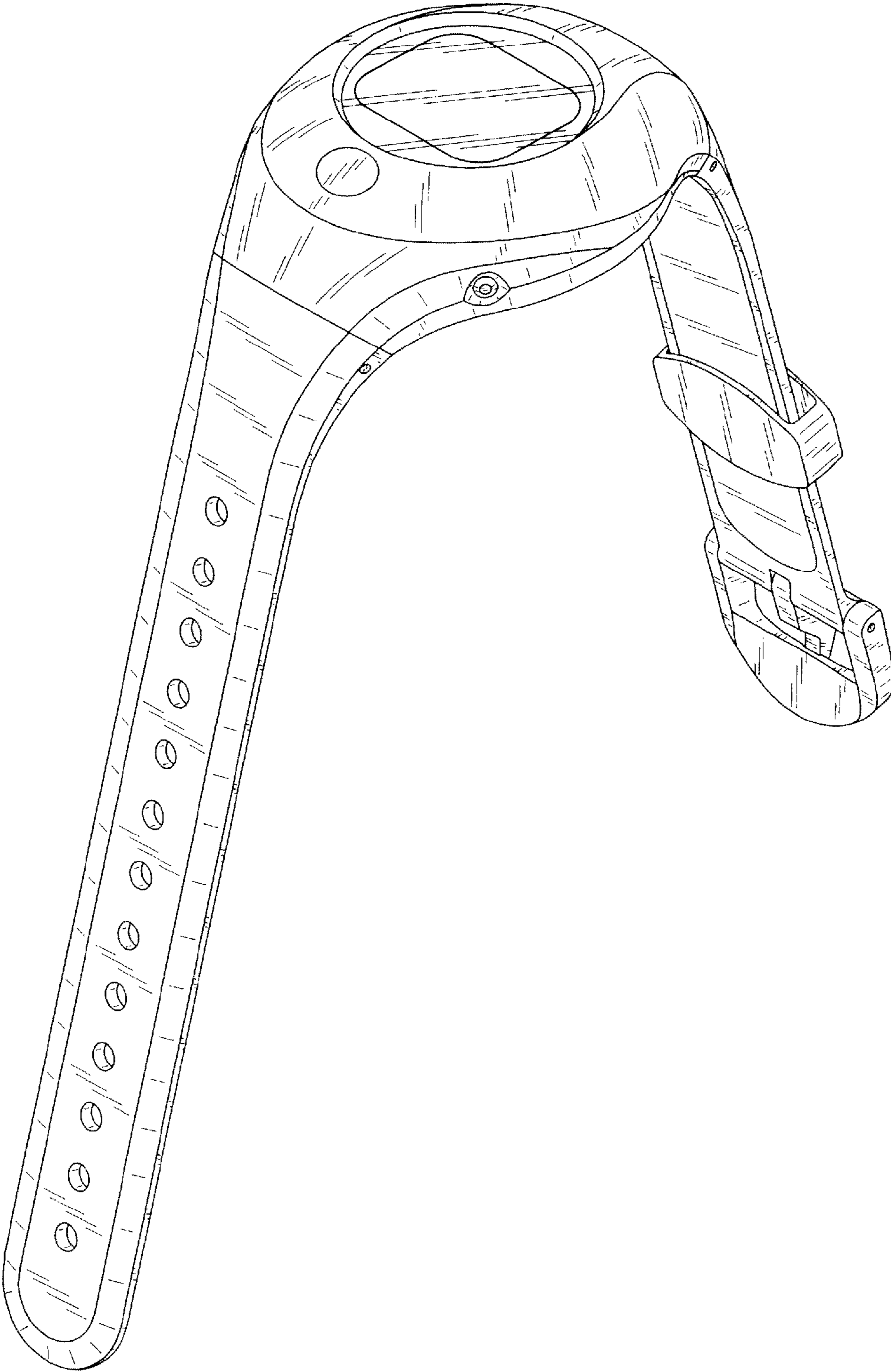

FIG. 1

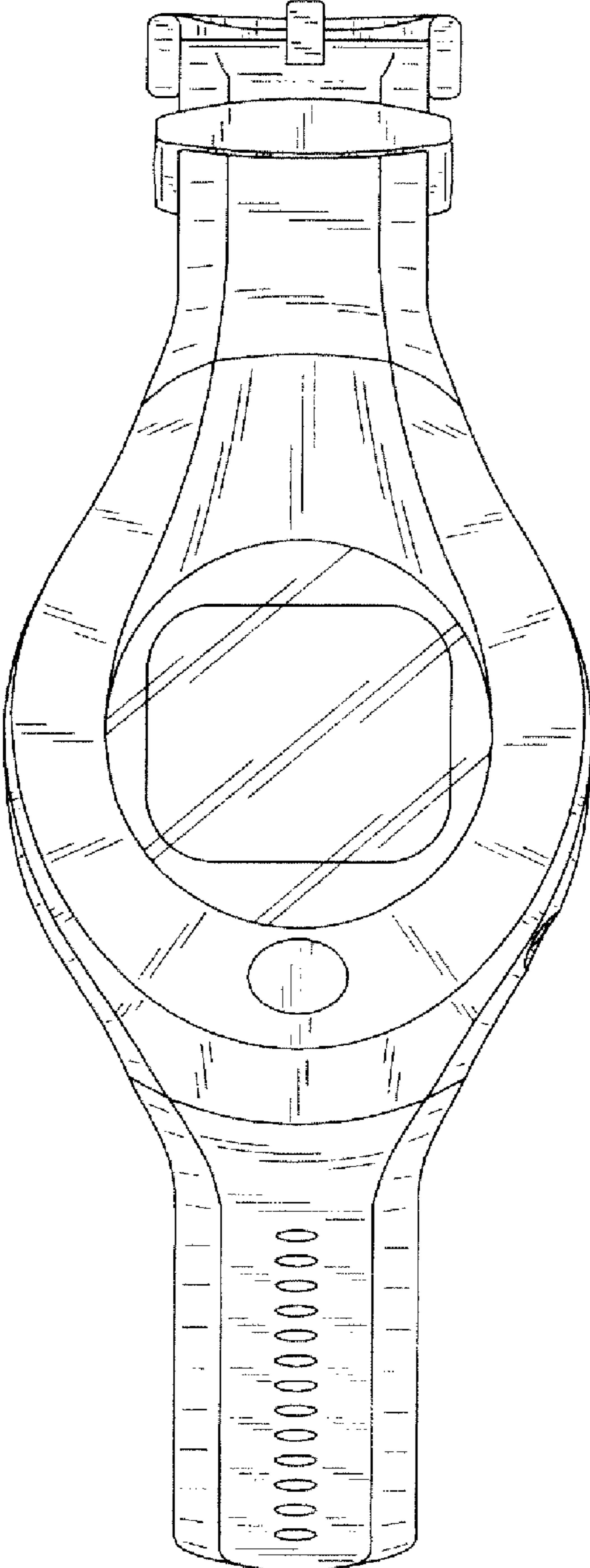

FIG. 2

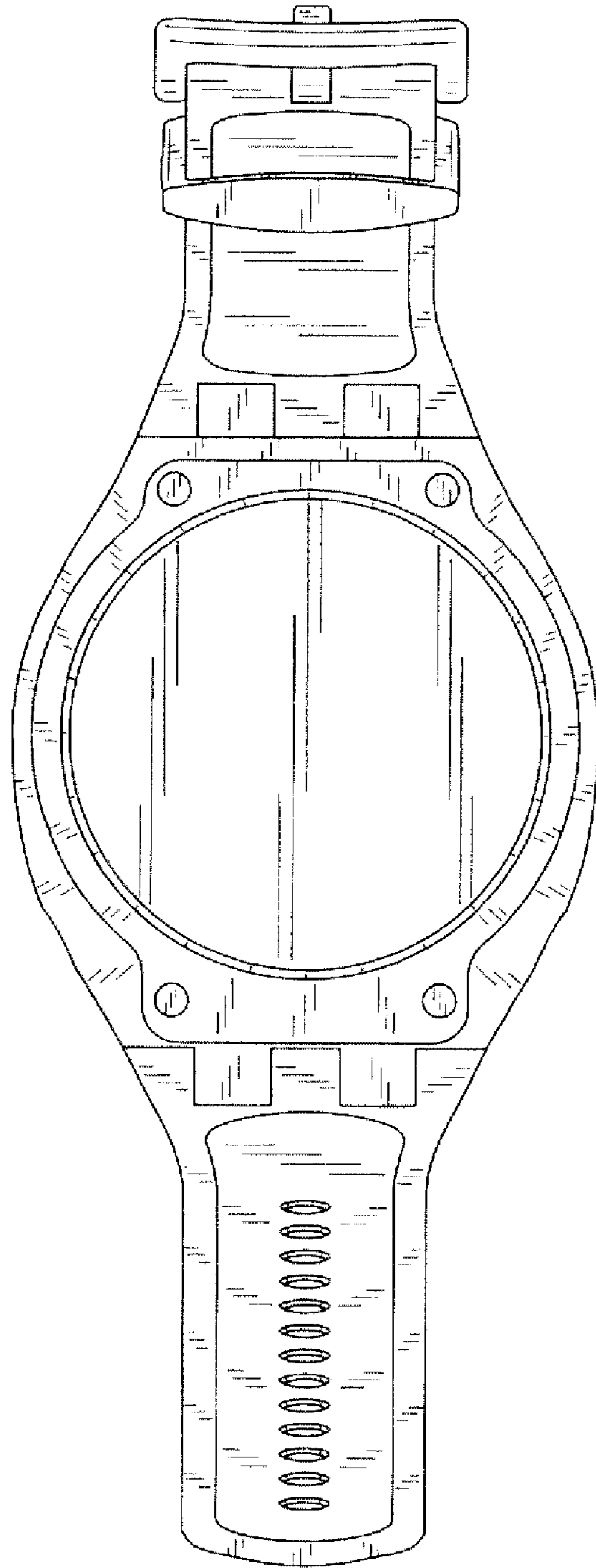

FIG. 3

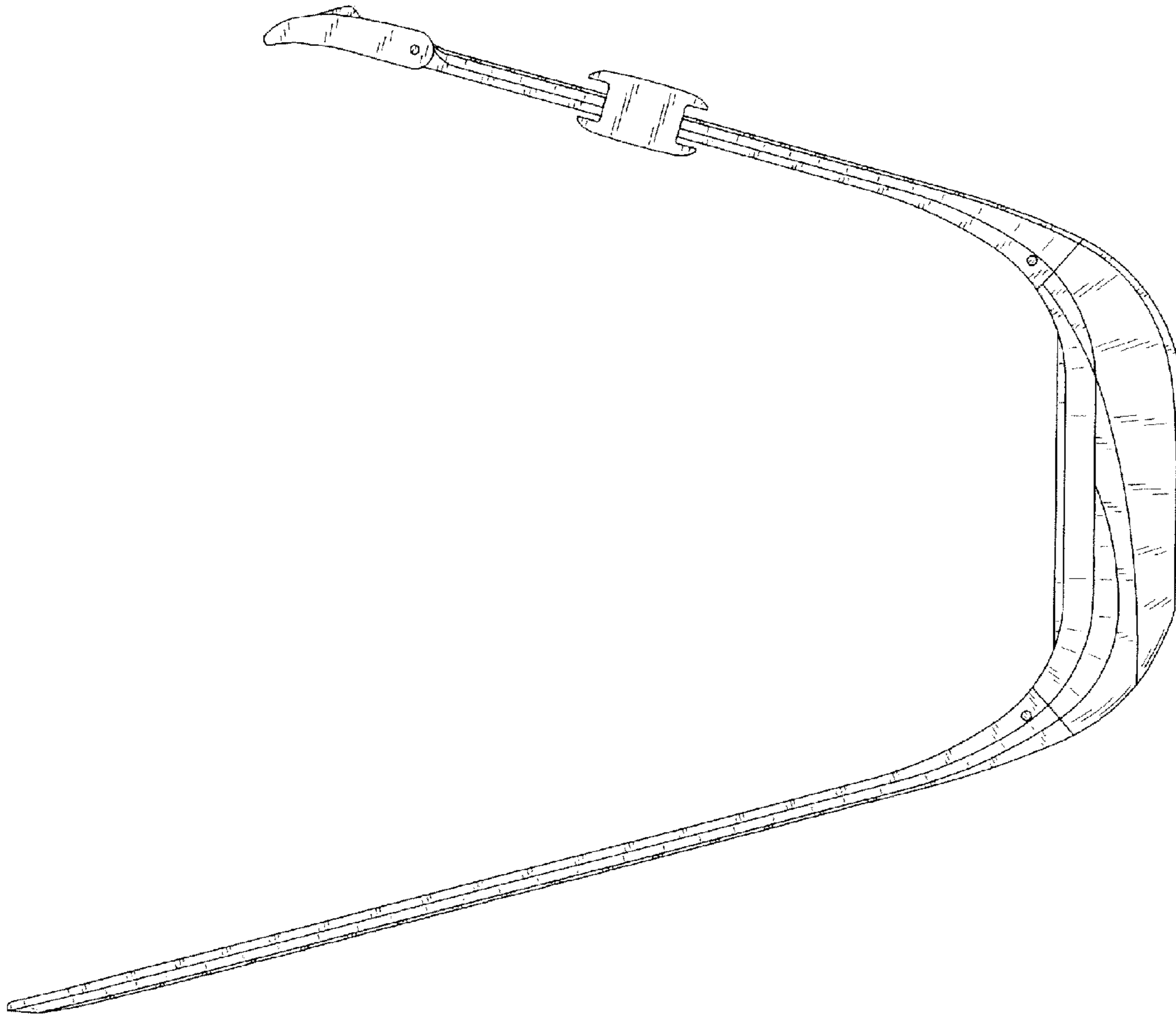

FIG. 4

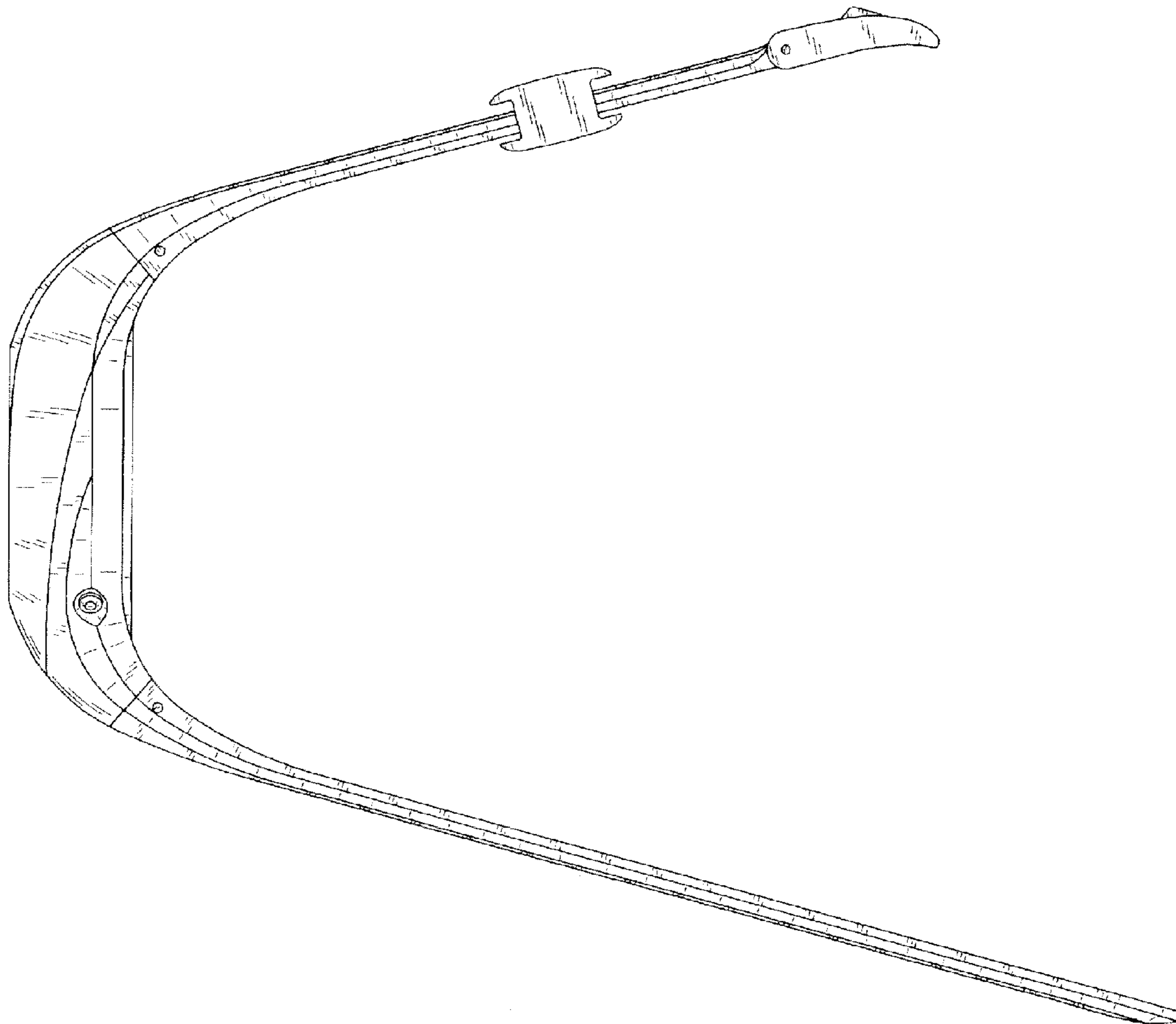

FIG. 5

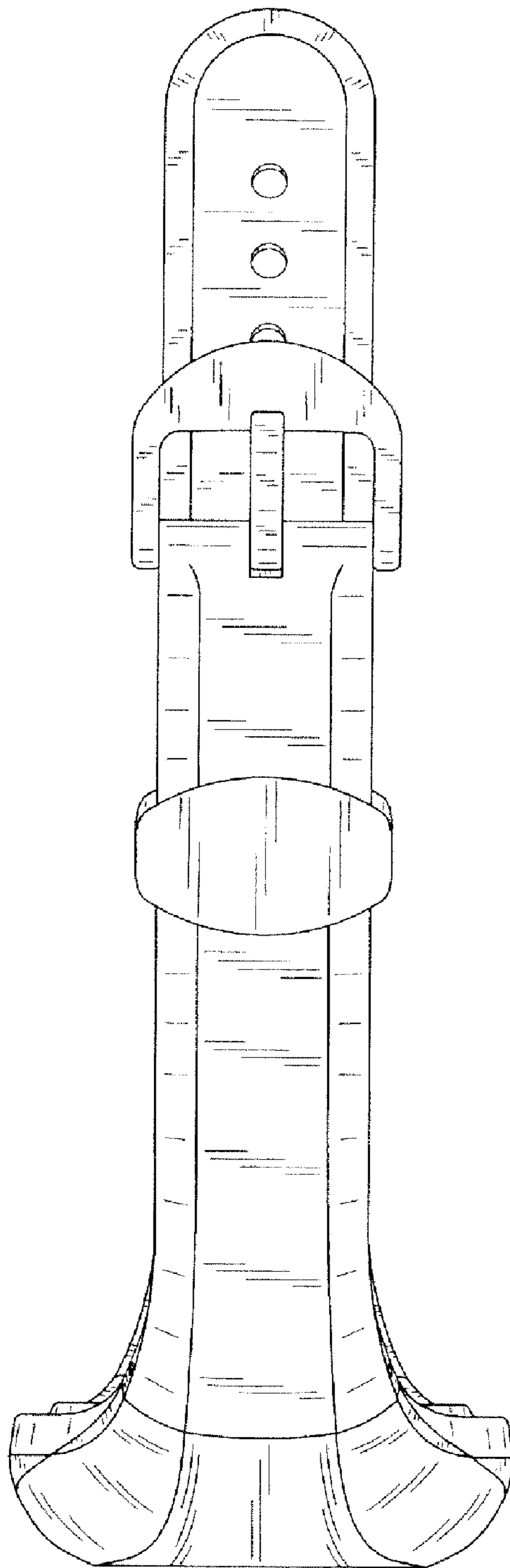

FIG. 6

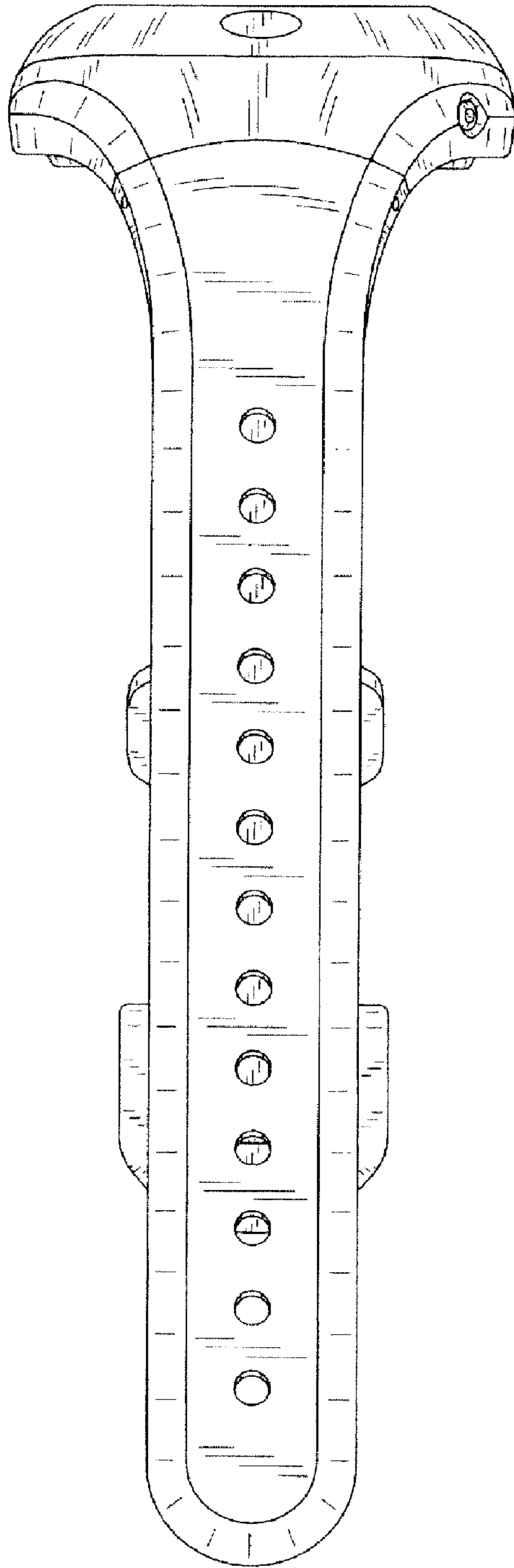

FIG. 7

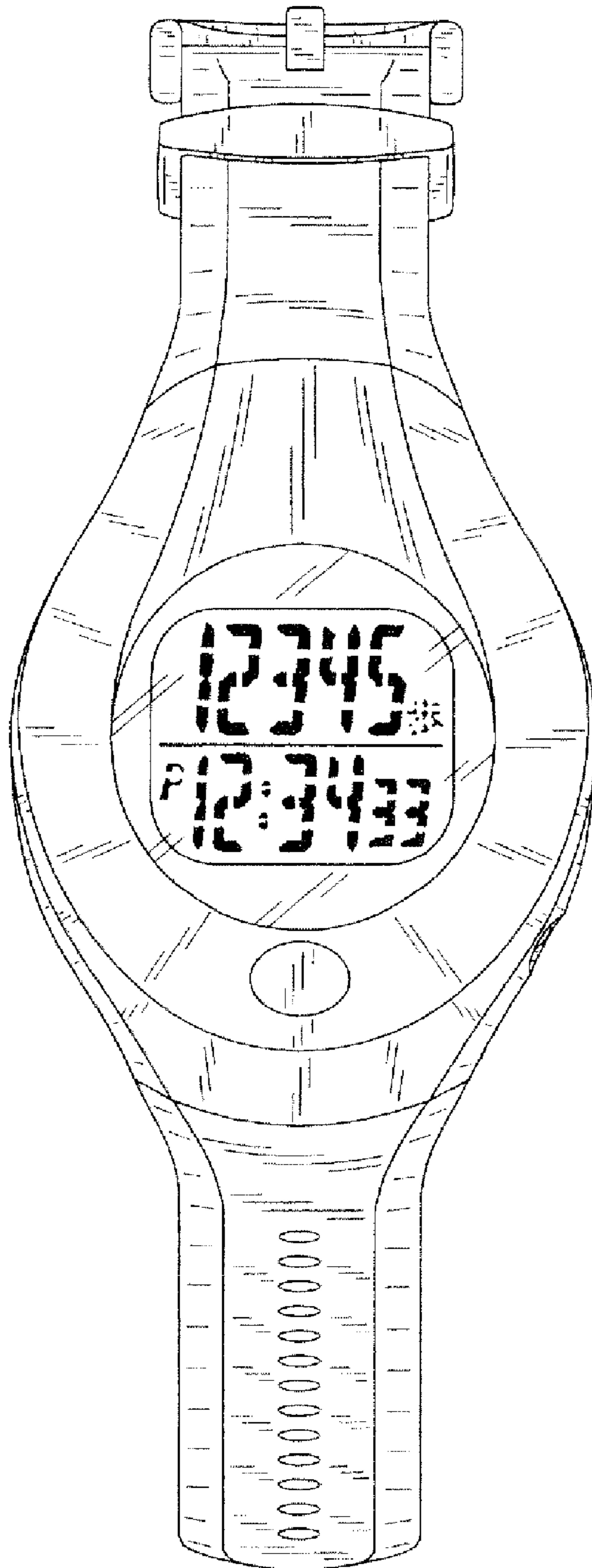

FIG. 8