



US00D586508S

(12) **United States Design Patent**  
**Strand**

(10) **Patent No.:** **US D586,508 S**

(45) **Date of Patent:** **\*\* Feb. 10, 2009**

(54) **PIPE FOR FIRE FIGHTING/EXTINGUISHING**

(57) **CLAIM**

(75) Inventor: **Lennart Strand**, Kristianstad (SE)

I claim the ornamental design for a pipe for fire fighting/ extinguishing, as shown.

(73) Assignee: **Waterfog AB**, Kristianstad (SE)

(\*\*) Term: **14 Years**

**DESCRIPTION**

(21) Appl. No.: **29/286,270**

FIG. 1 is a side perspective view of the pipe for fire fighting/ extinguishing from the top;

(22) Filed: **Apr. 30, 2007**

FIG. 2 is a side perspective view of the pipe for fire fighting/ extinguishing from the bottom;

(51) **LOC (9) Cl.** ..... **29-99**

(52) **U.S. Cl.** ..... **D29/129**

(58) **Field of Classification Search** ..... D25/125,  
D25/128, 129; D23/213, 214, 217, 223,  
D23/229; 169/5, 16, 26, 30, 35, 37, 44, 46,  
169/48, 54, 74, 88, 89; 239/525, 530-532

FIG. 3 is a side view of the pipe for fire fighting/ extinguish- ing;

FIG. 4 is another side view of the pipe for fire fighter/ extin- guishing;

FIG. 5 is an opposite side view of the pipe for fire fighter/ extinguishing shown in FIG. 3;

See application file for complete search history.

FIG. 6 is an opposite side view of the pipe for fire fighter/ extinguishing shown in FIG. 4;

(56) **References Cited**

**U.S. PATENT DOCUMENTS**

D89,904	S *	5/1933	McArdle	.....	D23/214
3,682,250	A *	8/1972	Horwinski	.....	169/5
3,768,567	A *	10/1973	Weise	.....	169/26
3,802,511	A *	4/1974	Good, Jr.	.....	169/30
4,359,096	A *	11/1982	Berger	.....	169/44
4,485,877	A *	12/1984	McMillan et al.	.....	169/48
D285,824	S *	9/1986	Anderson	.....	D23/214
4,634,833	A *	1/1987	Chemnitz	.....	169/46
6,189,625	B1 *	2/2001	Hopkins	.....	169/88
6,267,788	B1 *	7/2001	Andersson	.....	169/74
6,425,537	B1 *	7/2002	Nielsen	.....	169/90
6,488,098	B1 *	12/2002	Davis et al.	.....	169/54
6,745,847	B2 *	6/2004	Kim	.....	169/37
D527,441	S *	8/2006	La Mesa et al.	.....	D23/214
2006/0185859	A1 *	8/2006	Lin	.....	169/74

\* cited by examiner

*Primary Examiner*—Holly H Baynham

*Assistant Examiner*—Cynthia M Chin

**1 Claim, 5 Drawing Sheets**

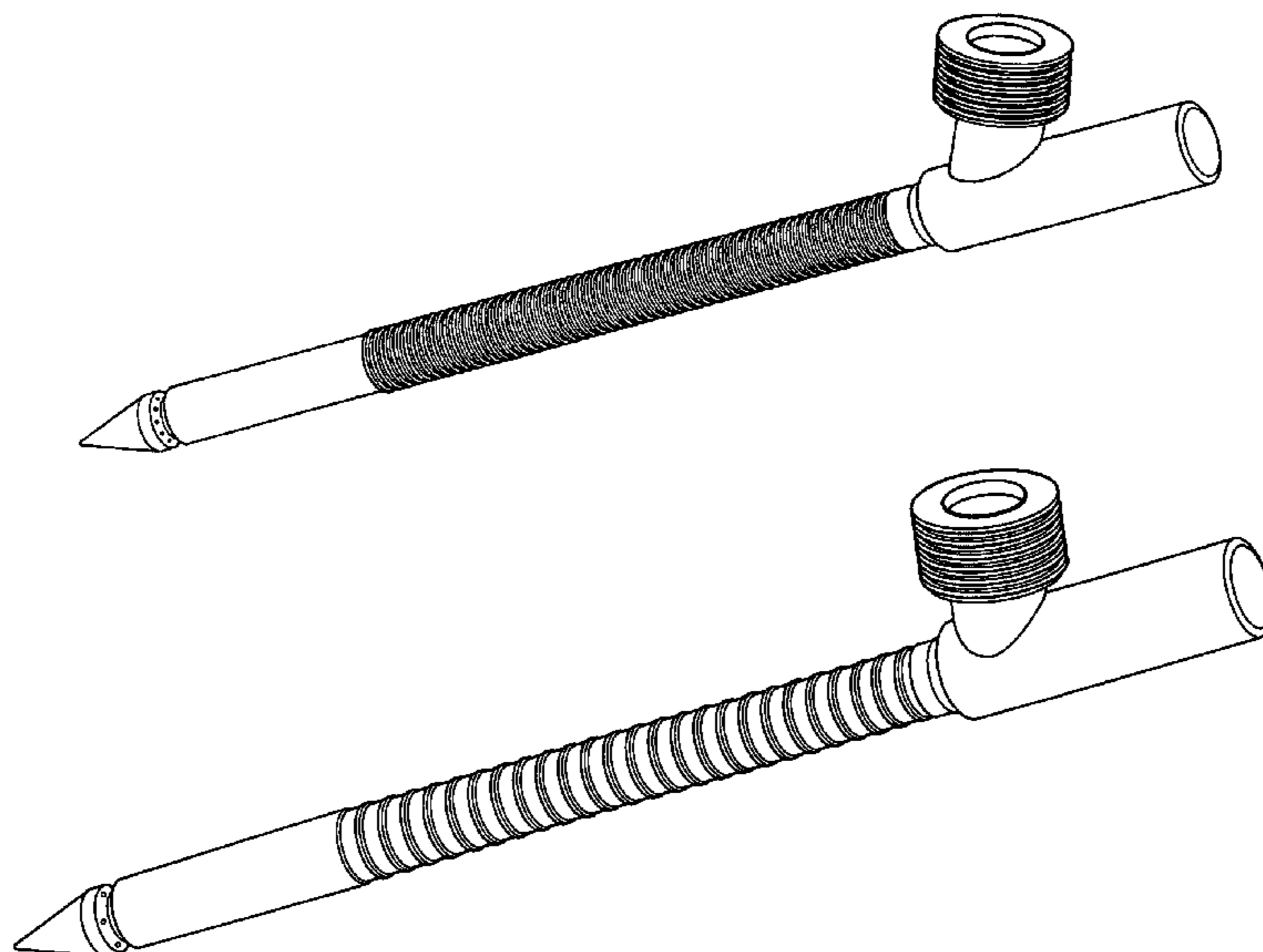

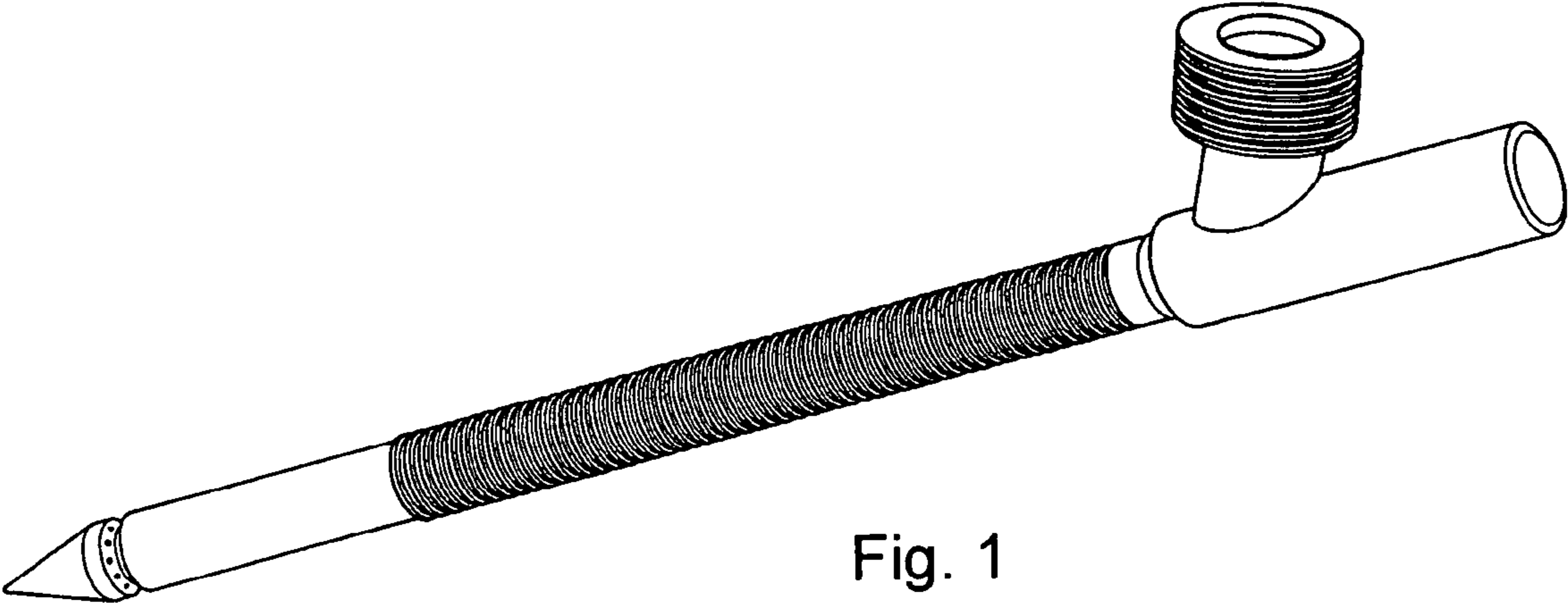

Fig. 1

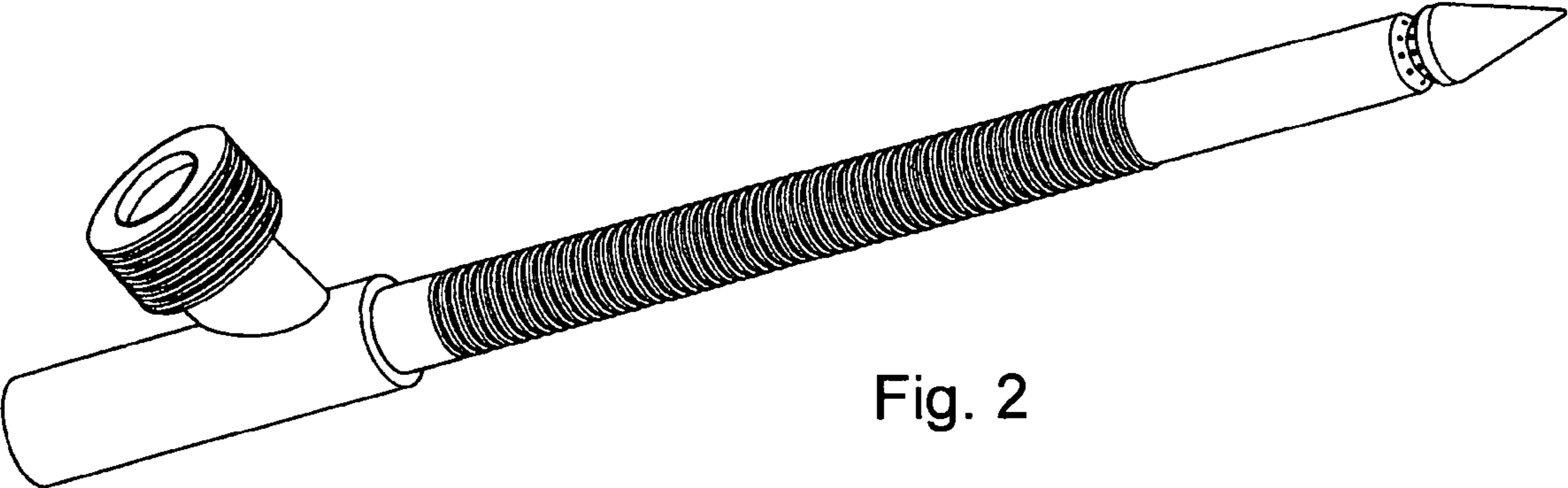

Fig. 2

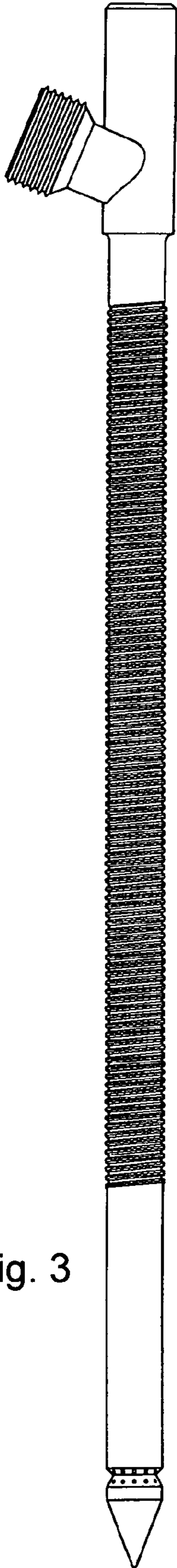

Fig. 3

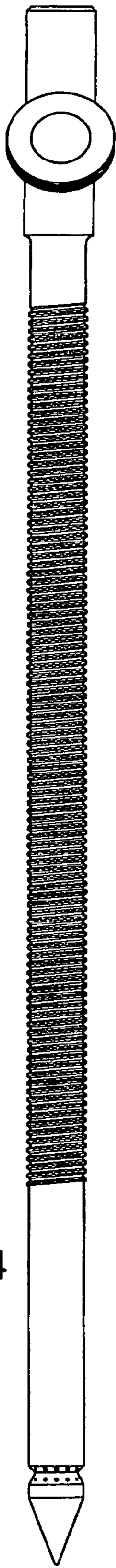

Fig. 4

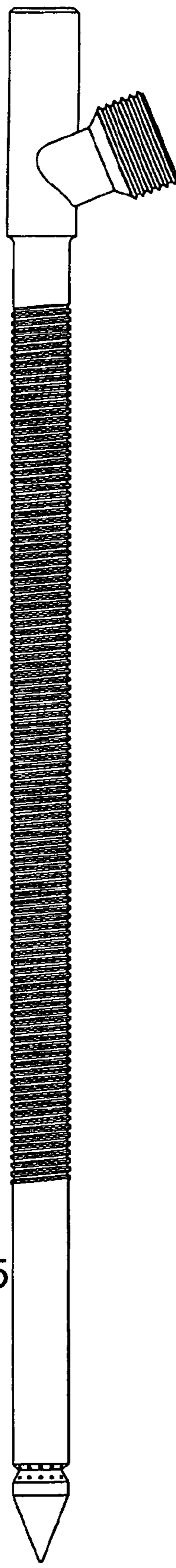

Fig. 5

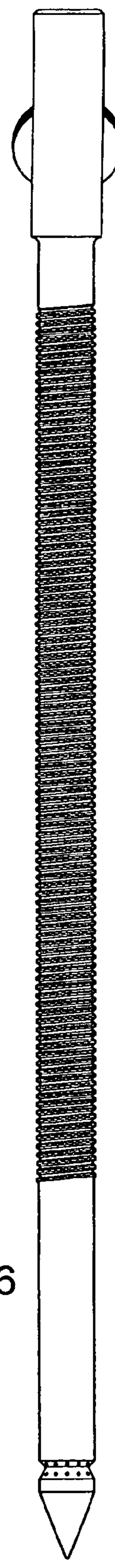

Fig. 6

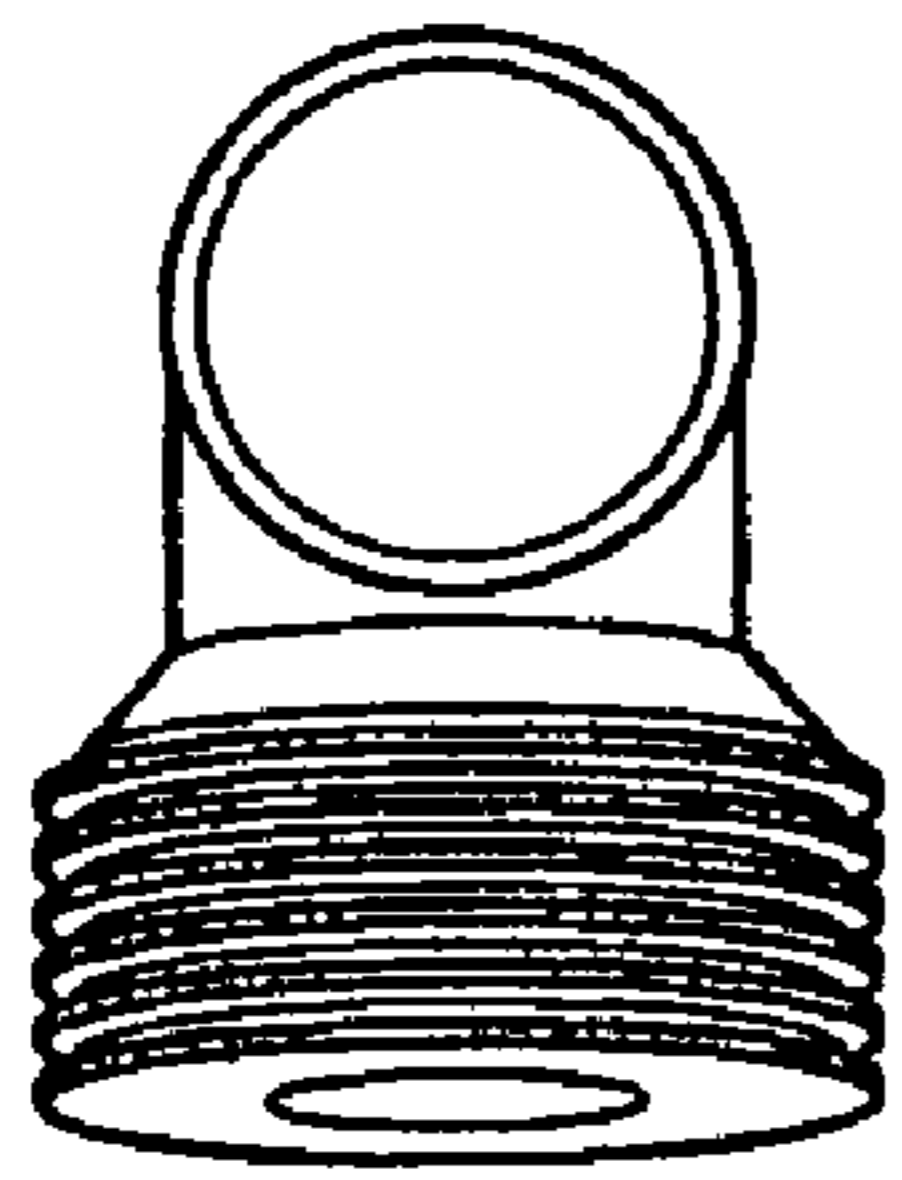

Fig. 7

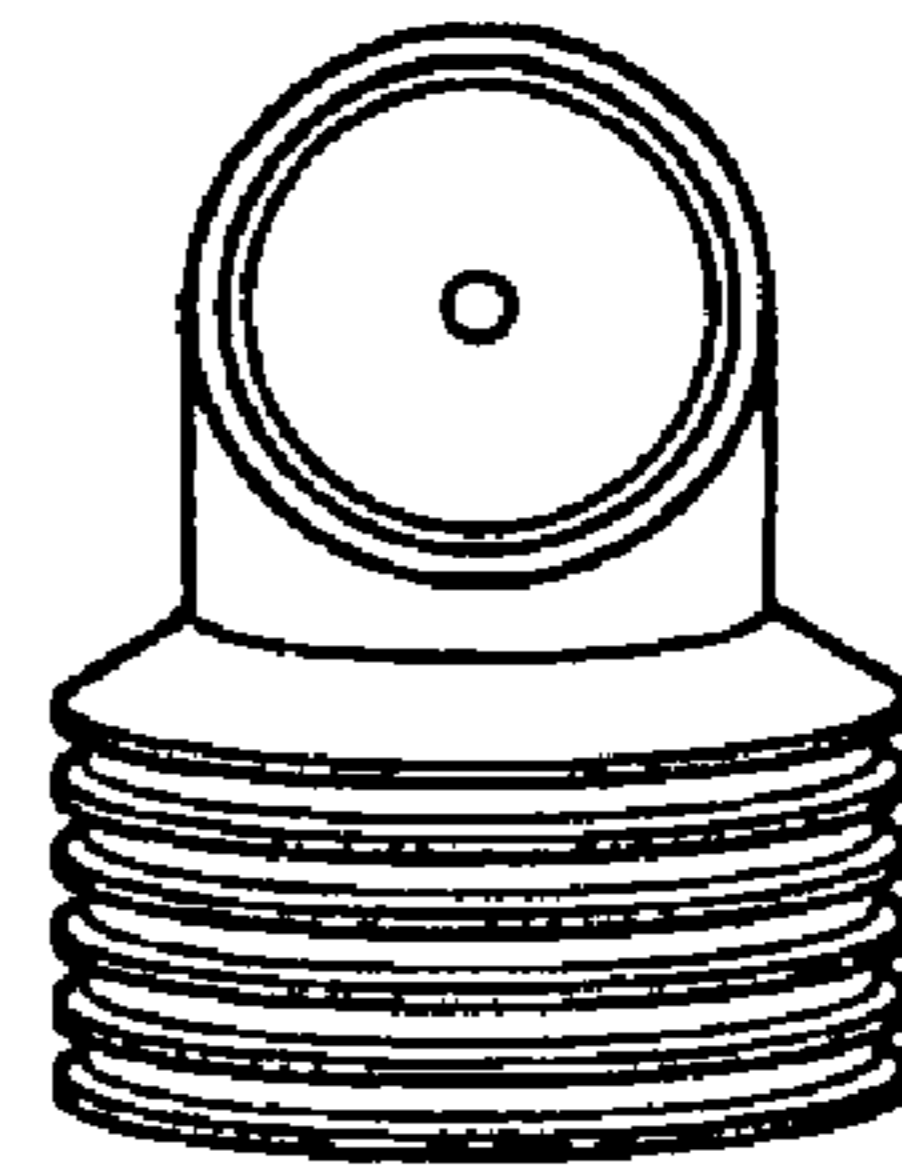

Fig. 8

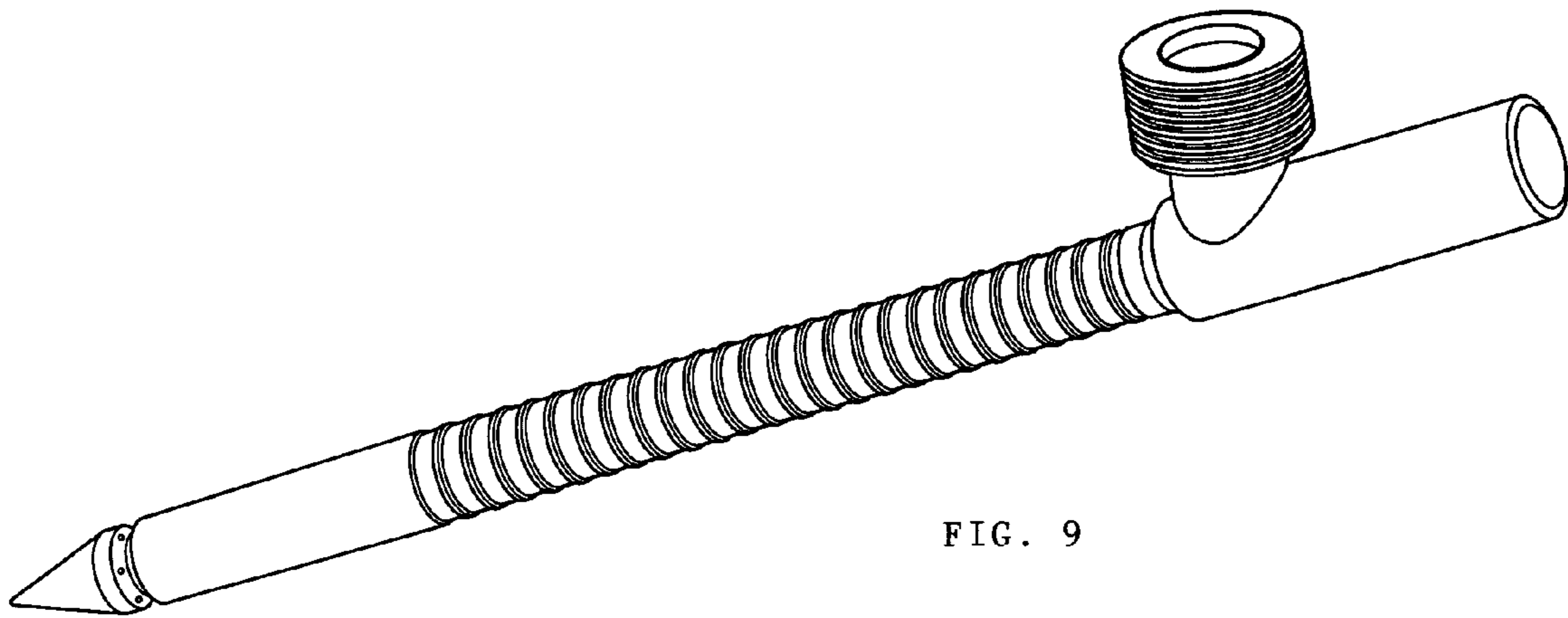

FIG. 9

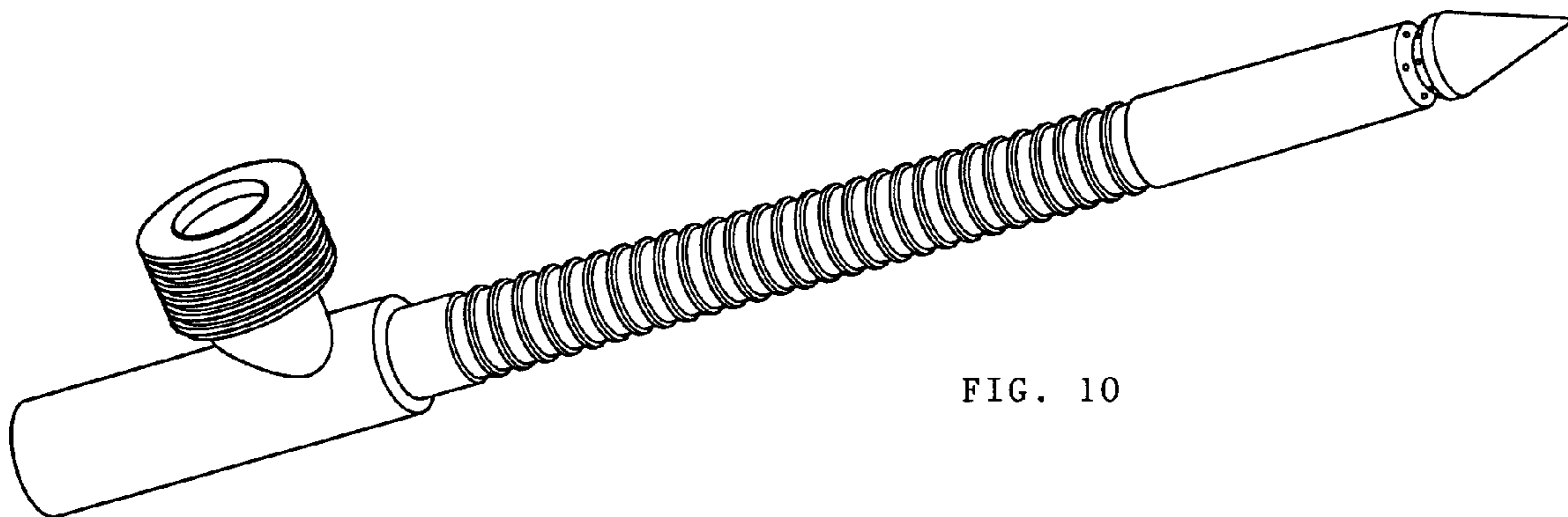

FIG. 10

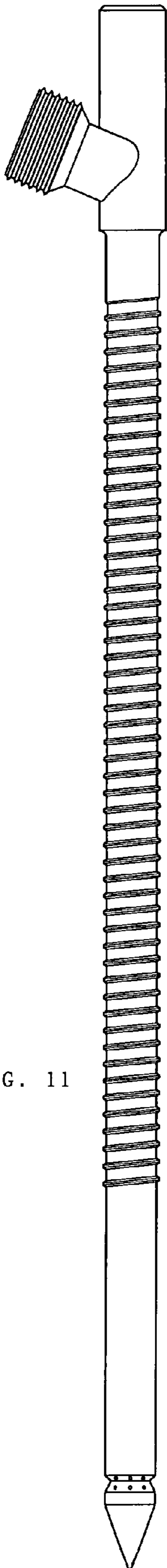

FIG. 11

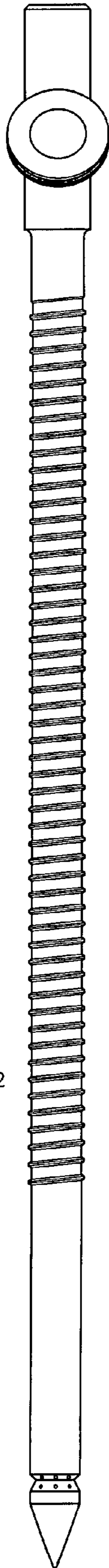

FIG. 12

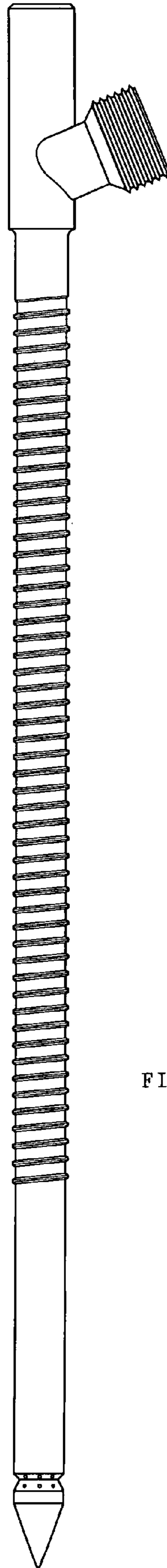

FIG. 13

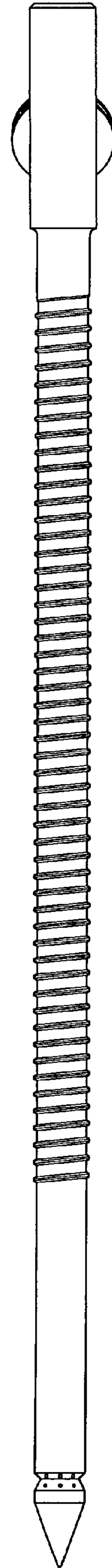

FIG. 14