



US00D586503S

(12) **United States Design Patent**
Lau

(10) **Patent No.:** **US D586,503 S**
(45) **Date of Patent:** **** Feb. 10, 2009**

(54) **HAIR CLIP**

(57) **CLAIM**

(76) Inventor: **Janet K. Lau**, 1937 Abreu Way, Union City, CA (US) 94587

The ornamental design for a hair clip, as shown and described.

(**) Term: **14 Years**

DESCRIPTION

(21) Appl. No.: **29/280,310**

(22) Filed: **May 23, 2007**

(51) **LOC (9) Cl.** **28-03**

(52) **U.S. Cl.** **D28/40; D28/39**

(58) **Field of Classification Search** D28/21-34,
D28/39-43; 132/101, 126, 128-131, 144,
132/148, 219, 275-284

See application file for complete search history.

FIG. 1 shows a perspective view of a first embodiment of a design for a hair clip.

FIG. 2 shows a right side view of the first embodiment.

FIG. 3 shows a left side view of the first embodiment.

FIG. 4 shows a top view of the first embodiment.

FIG. 5 shows a bottom view of the first embodiment.

FIG. 6 shows a front view of the first embodiment.

FIG. 7 shows a back view of the first embodiment.

FIG. 8 shows a perspective view of the first embodiment in an open position.

FIG. 9 shows a perspective view of a second embodiment of a design for a hair clip.

FIG. 10 shows a right side view of the second embodiment.

FIG. 11 shows a left side view of the second embodiment.

FIG. 12 shows a top view of the second embodiment.

FIG. 13 shows a bottom view of the second embodiment.

FIG. 14 shows a front view of the second embodiment.

FIG. 15 shows a back view of the second embodiment.

FIG. 16 shows a perspective view of a third embodiment of a design for a hair clip.

FIG. 17 shows a right side view of the third embodiment.

FIG. 18 shows a left side view of the third embodiment.

FIG. 19 shows a top view of the third embodiment.

FIG. 20 shows a bottom view of the third embodiment.

FIG. 21 shows a front view of the third embodiment; and,

FIG. 22 shows a back view of the third embodiment.

The broken-line features in the figures are for illustrative purposes only and form no part of the claimed design.

(56) **References Cited**

U.S. PATENT DOCUMENTS

442,222	A	12/1890	Gunderson
637,510	A	11/1899	Holm
854,901	A	5/1907	Mooers
1,194,844	A	8/1916	Kalinowska
1,356,785	A	10/1920	Patterson
1,381,216	A	6/1921	Muscente
1,443,443	A	1/1923	Tanner
1,488,864	A	4/1924	Canaday

(Continued)

FOREIGN PATENT DOCUMENTS

CA	740681	8/1966
----	--------	--------

(Continued)

OTHER PUBLICATIONS

Ficcare Product Catalog, VisionMax Inc., 24 pages (2005).

(Continued)

Primary Examiner—Janice E. Seeger

Assistant Examiner—Zenia I Bennett

(74) *Attorney, Agent, or Firm*—Aka Chan LLP

1 Claim, 19 Drawing Sheets

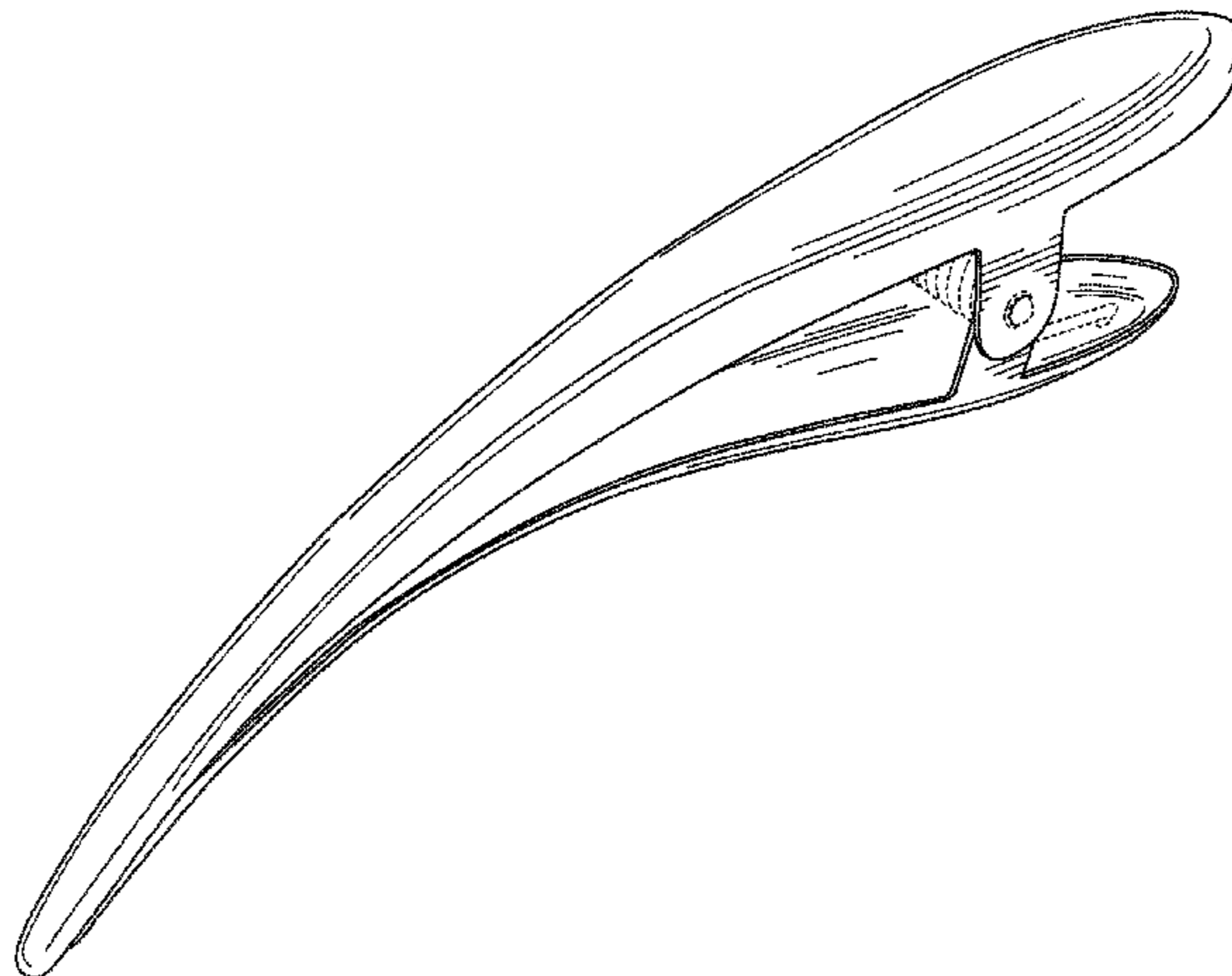

US D586,503 S

Page 2

U.S. PATENT DOCUMENTS

1,589,228 A 6/1926 Robb
1,675,806 A 7/1928 Holden
1,731,522 A 10/1929 Carlson
1,753,254 A 4/1930 Thaxton
1,781,812 A * 11/1930 Goodman et al. 132/224
1,788,835 A 1/1931 Hurst
2,160,346 A 5/1939 Valentine
2,201,719 A 5/1940 Eicher
2,459,926 A 1/1949 D'Alberto
2,597,254 A 5/1952 Meohas
D167,766 S 9/1952 Olevin
2,629,915 A 3/1953 Weiss
2,641,266 A 6/1953 Thatcher
2,813,533 A 11/1957 Fay
D203,095 S 11/1965 Schroeder
3,676,902 A 7/1972 Pearson
D257,792 S 1/1981 Chao
D348,121 S 6/1994 Park
D357,550 S * 4/1995 Smith D28/42
5,477,870 A 12/1995 Menaged
D374,500 S * 10/1996 Yasuda D28/39
5,666,982 A 9/1997 Pignon
5,758,672 A 6/1998 Chou
D403,110 S 12/1998 Patel
D403,111 S 12/1998 Patel
5,896,865 A 4/1999 Patel

D410,568 S 6/1999 Yasuda
D415,312 S 10/1999 Yasuda
6,019,107 A 2/2000 Overmyer et al.
6,019,108 A 2/2000 Chen
D429,030 S 8/2000 Yasuda
6,095,155 A 8/2000 Criscuolo
6,257,251 B1 7/2001 Burleson et al.
D454,657 S 3/2002 Lau
D480,509 S 10/2003 Yasuda
D511,863 S 11/2005 Lau
D529,231 S 9/2006 Lau
D540,982 S * 4/2007 Vergona D28/40
D566,895 S * 4/2008 Vergona D28/40

FOREIGN PATENT DOCUMENTS

DE 1929955 12/1969
FR 600369 11/1925
FR 770291 9/1934
FR 777224 2/1935
GB 402682 12/1933
NO 74017 9/1949

OTHER PUBLICATIONS

Hong Kong Enterprose, Jun. 1998, p. 72, Universal Manufacturing Co., hair clip #20, top photograph.

* cited by examiner

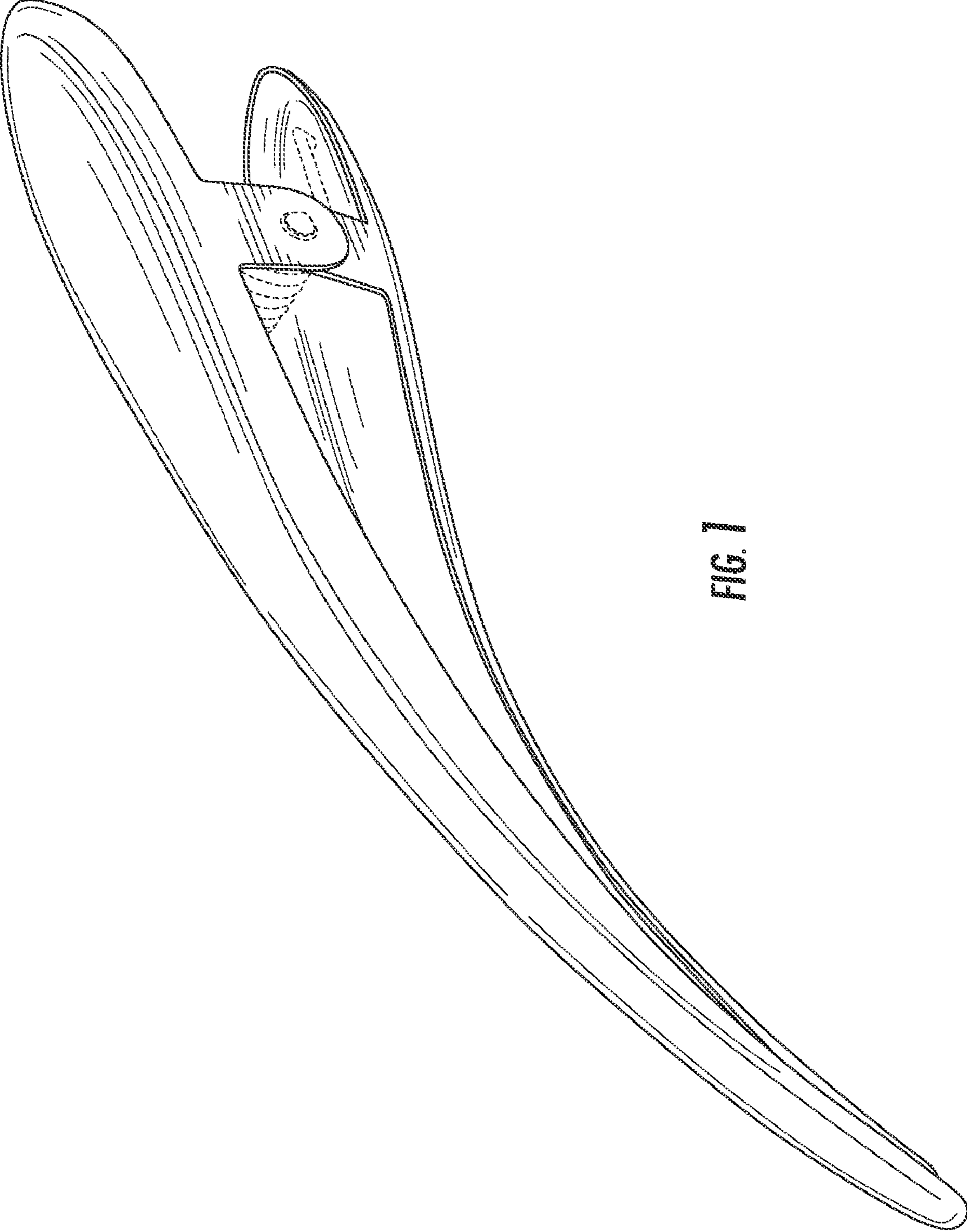

FIG. 1

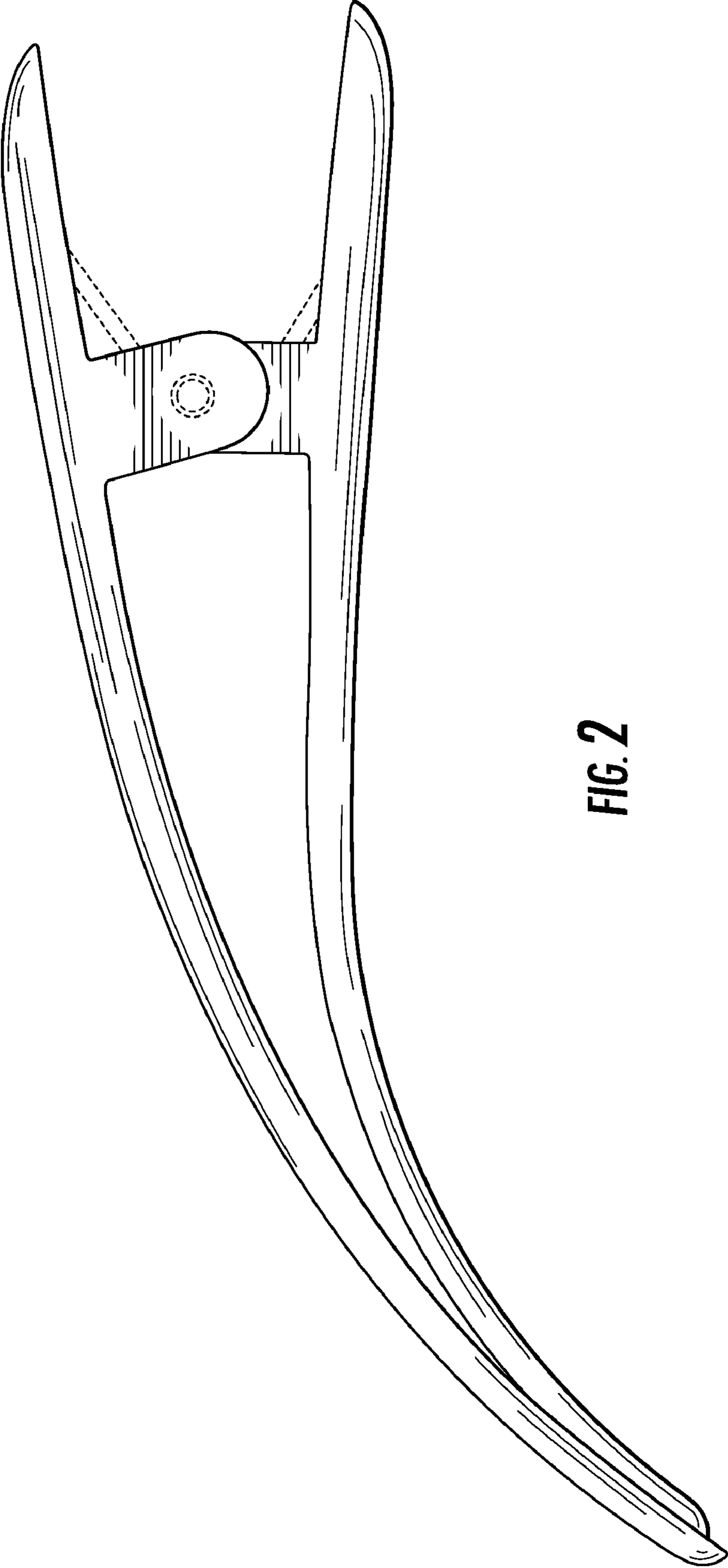

FIG. 2

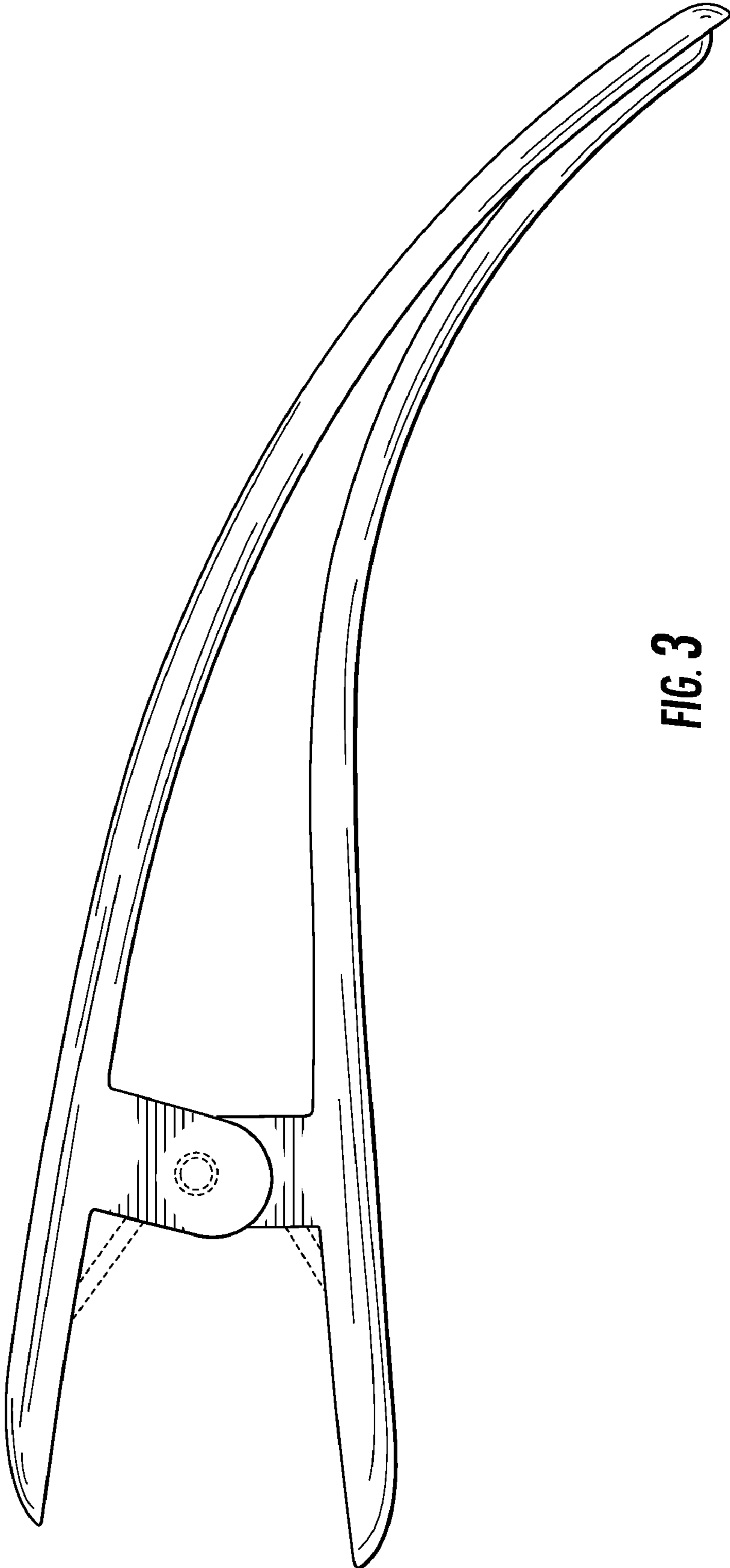

FIG. 3

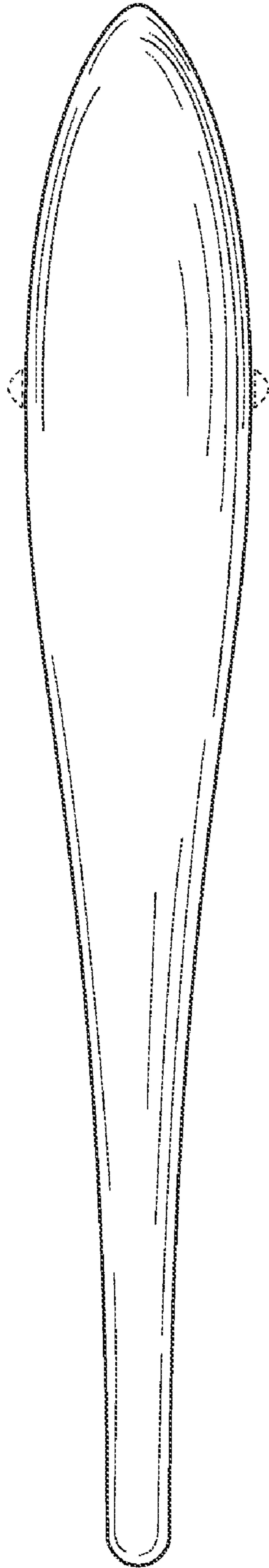

FIG. 4

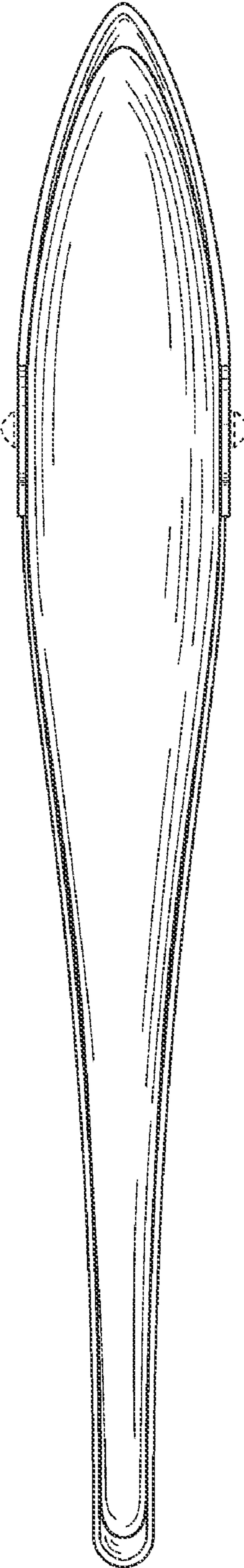

FIG. 5

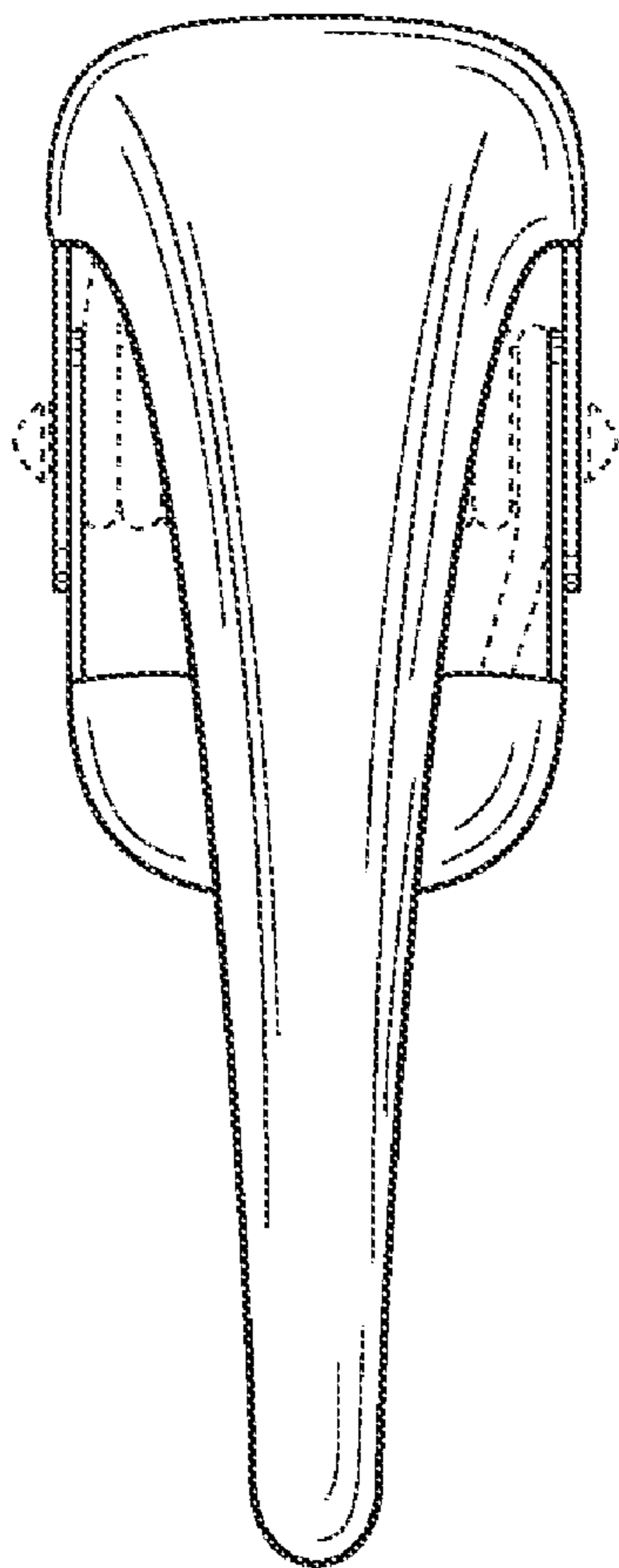

FIG. 6

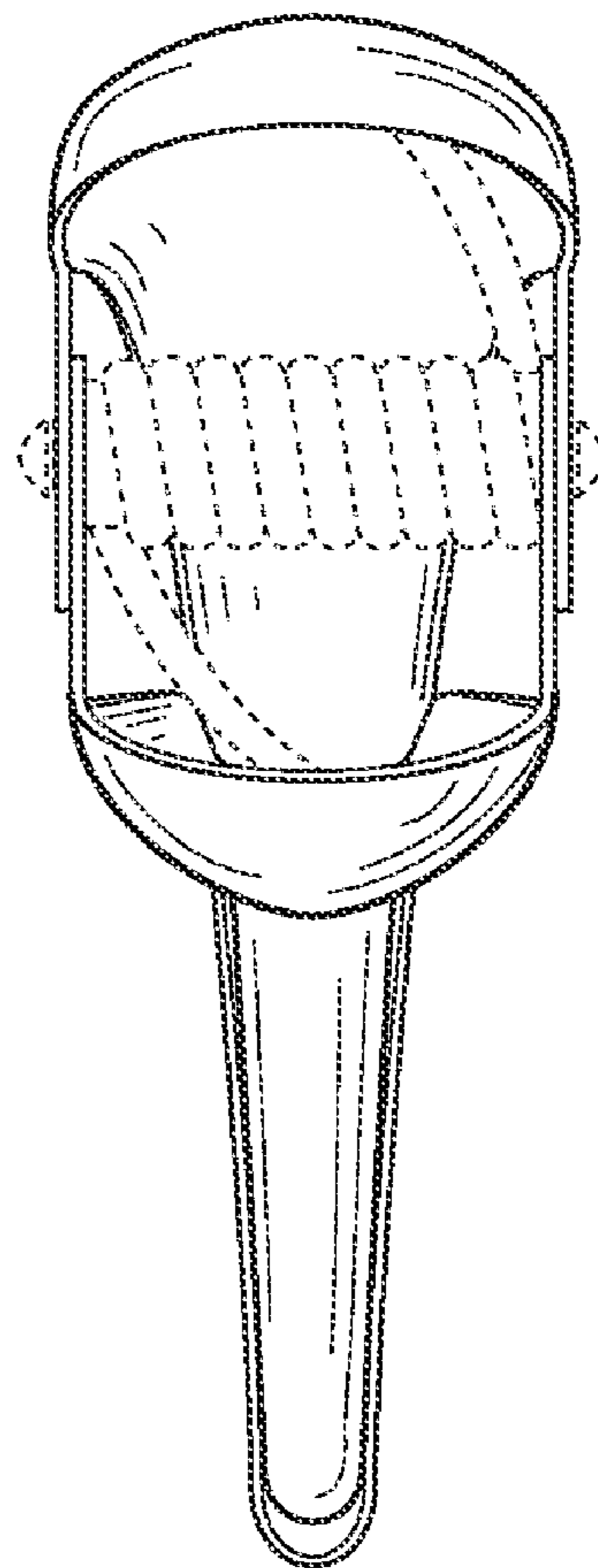

FIG. 7

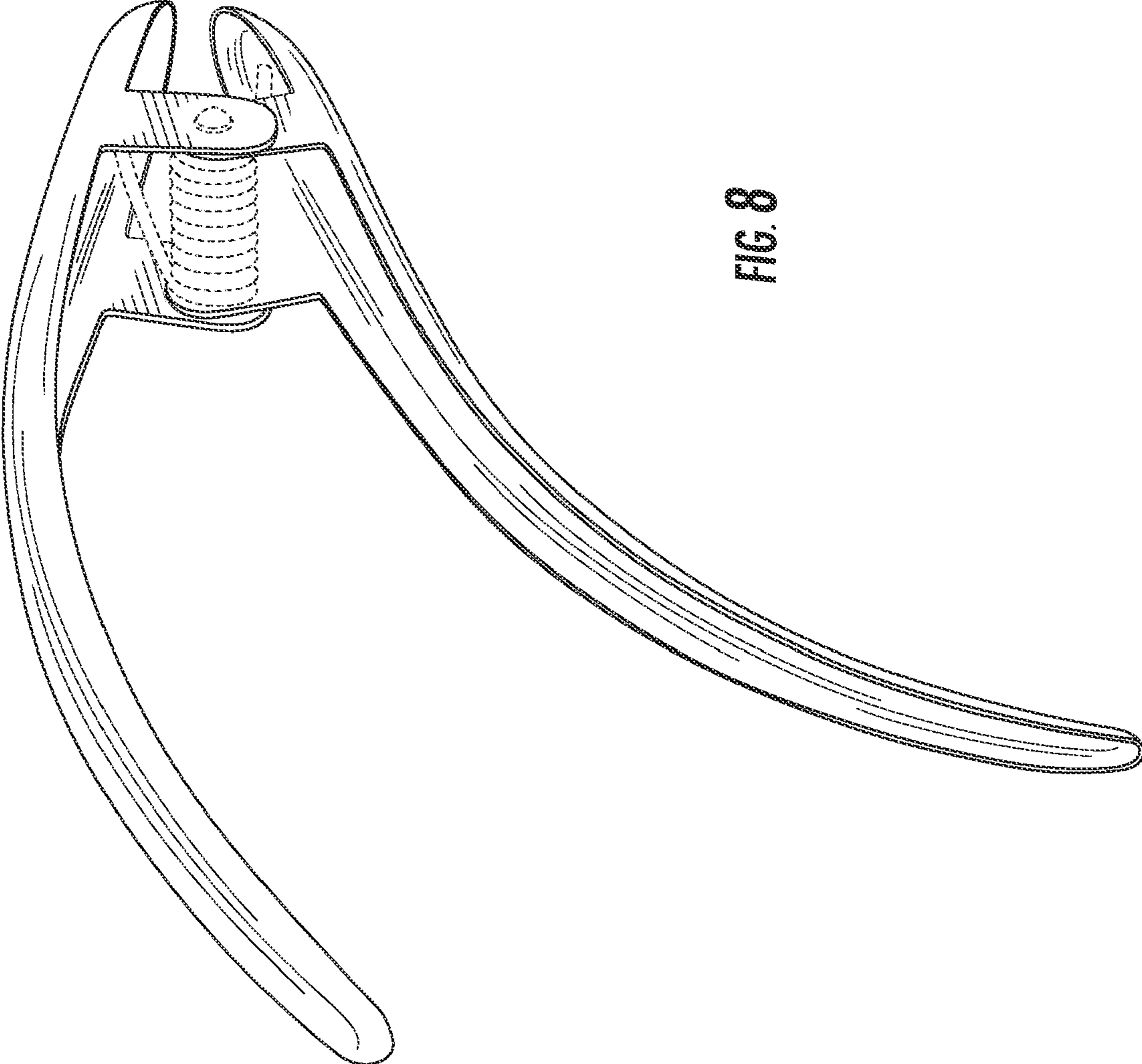

FIG. 8

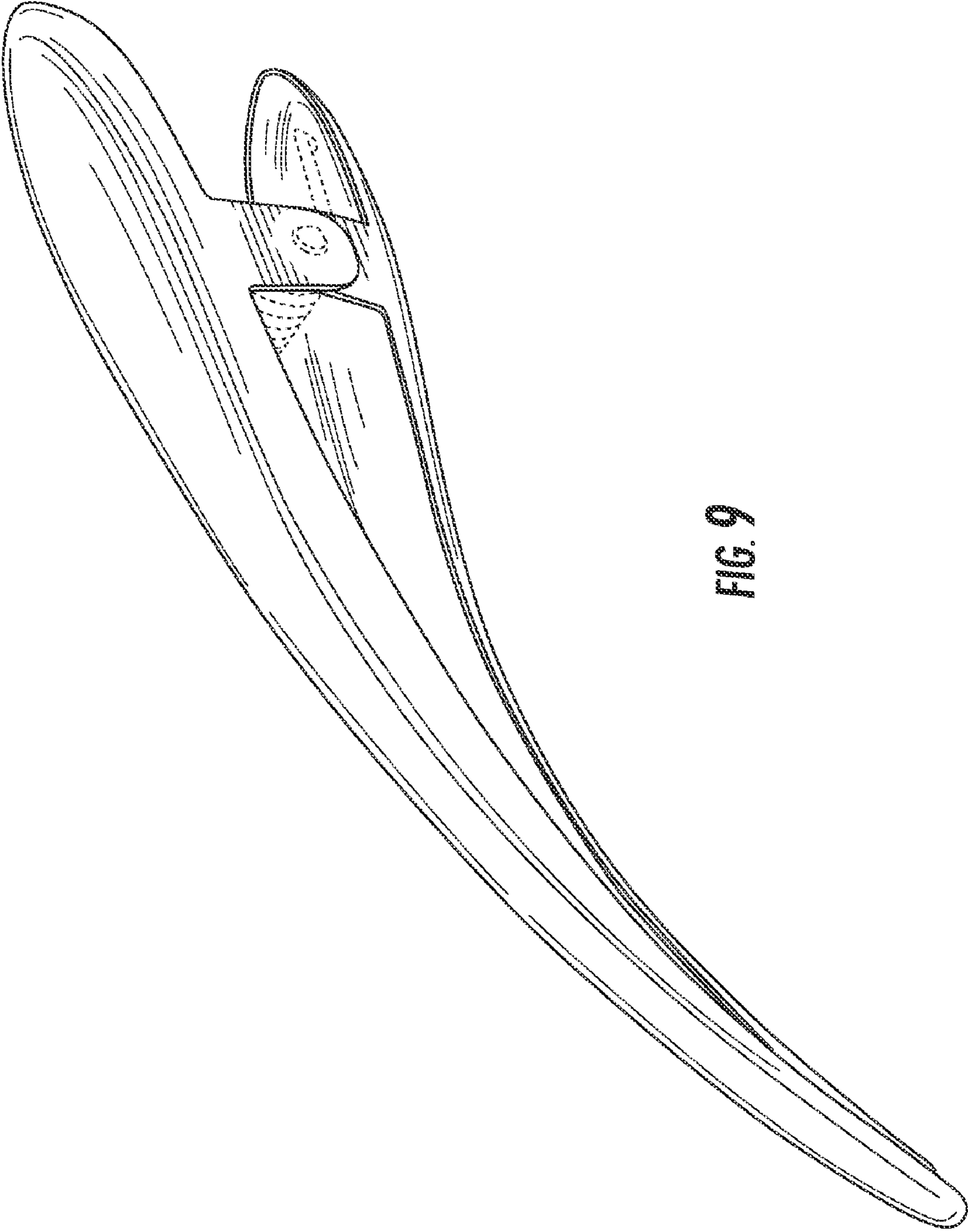

FIG. 9

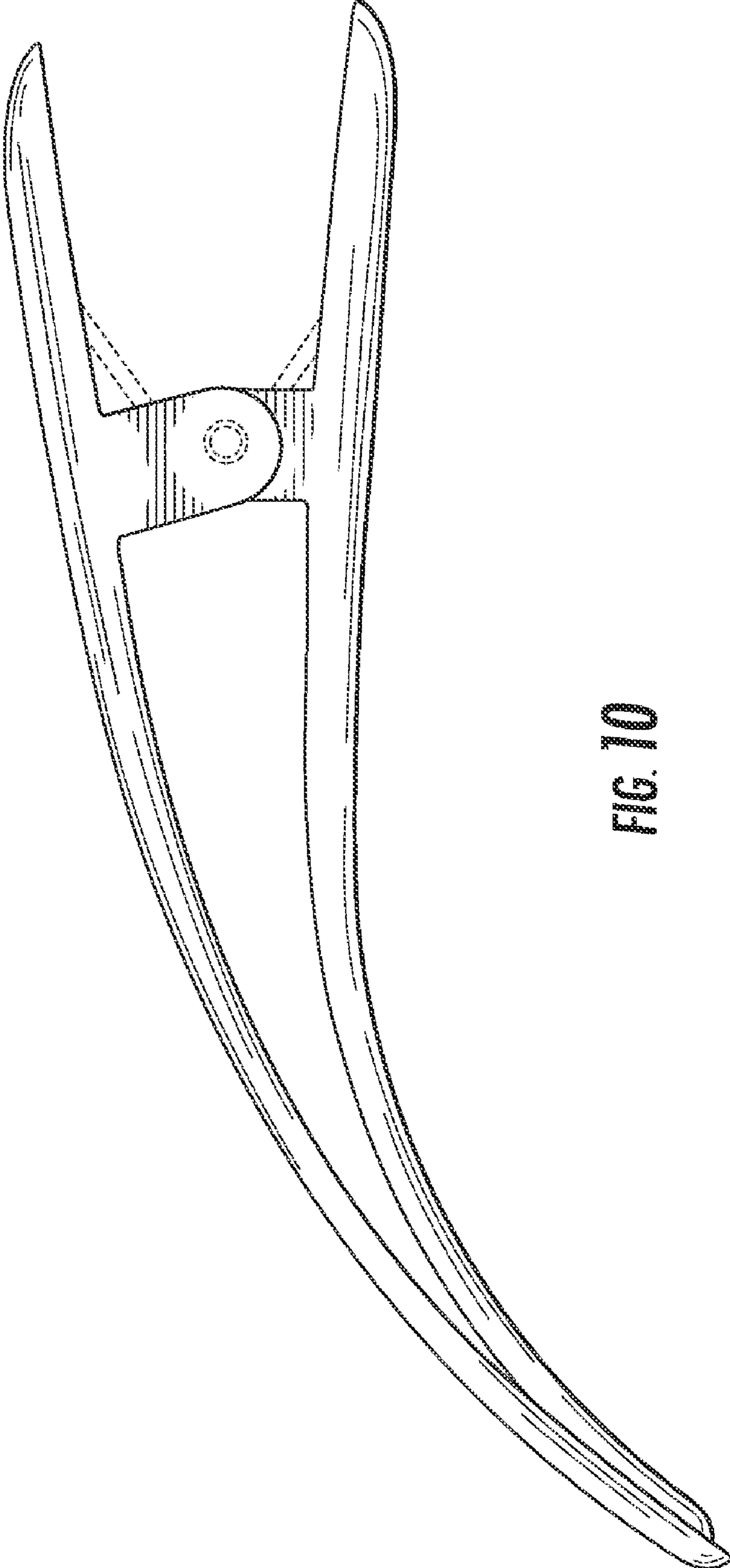

FIG. 10

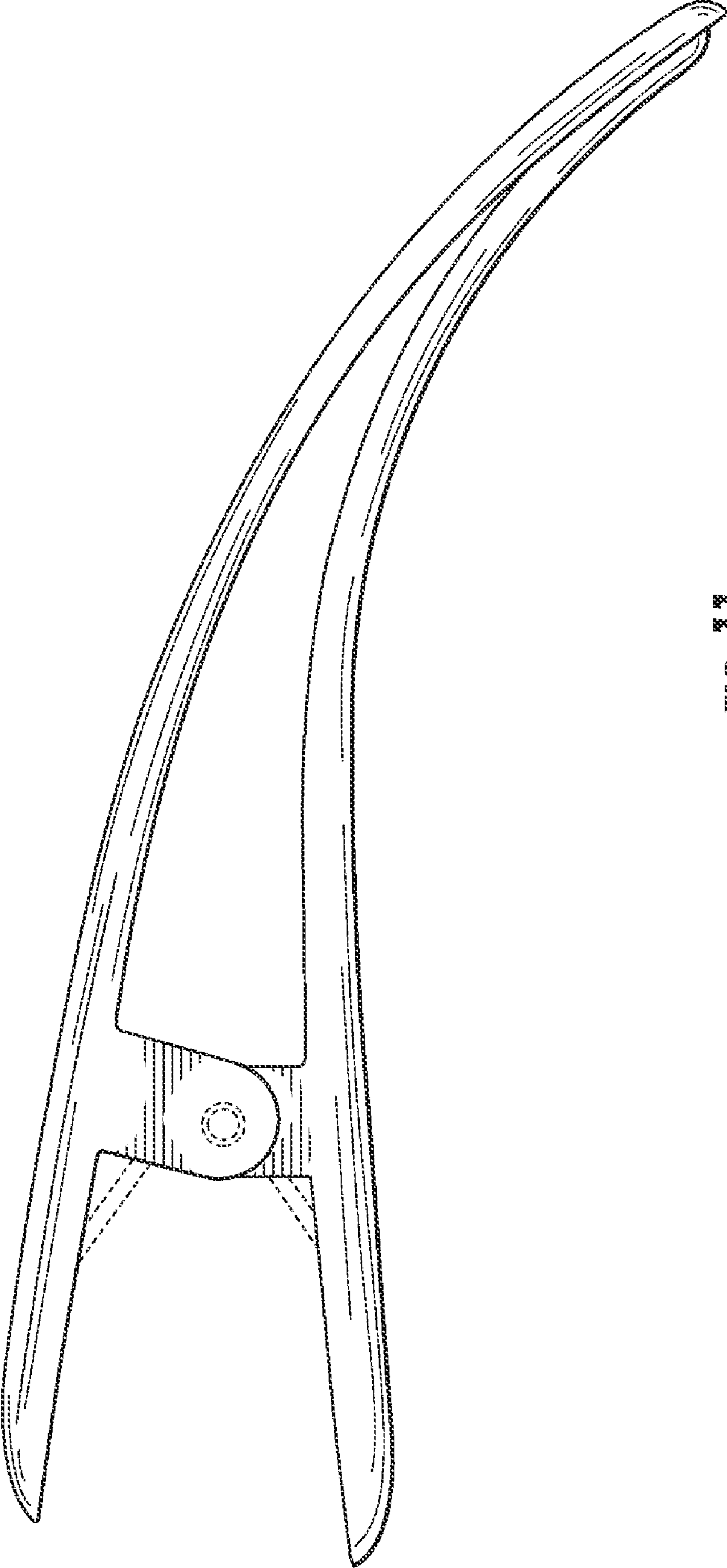

FIG. 11

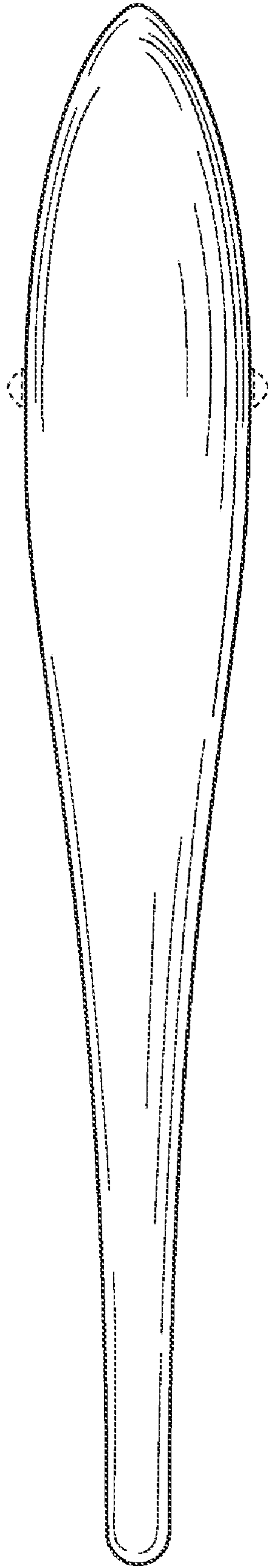

FIG. 12

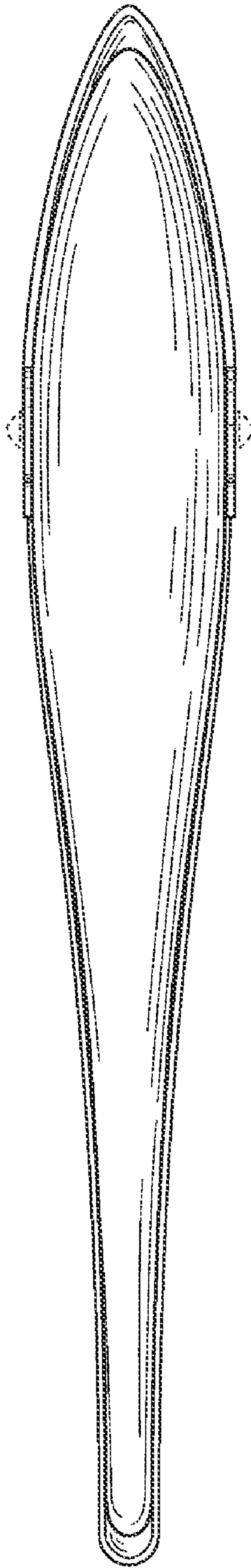

FIG. 13

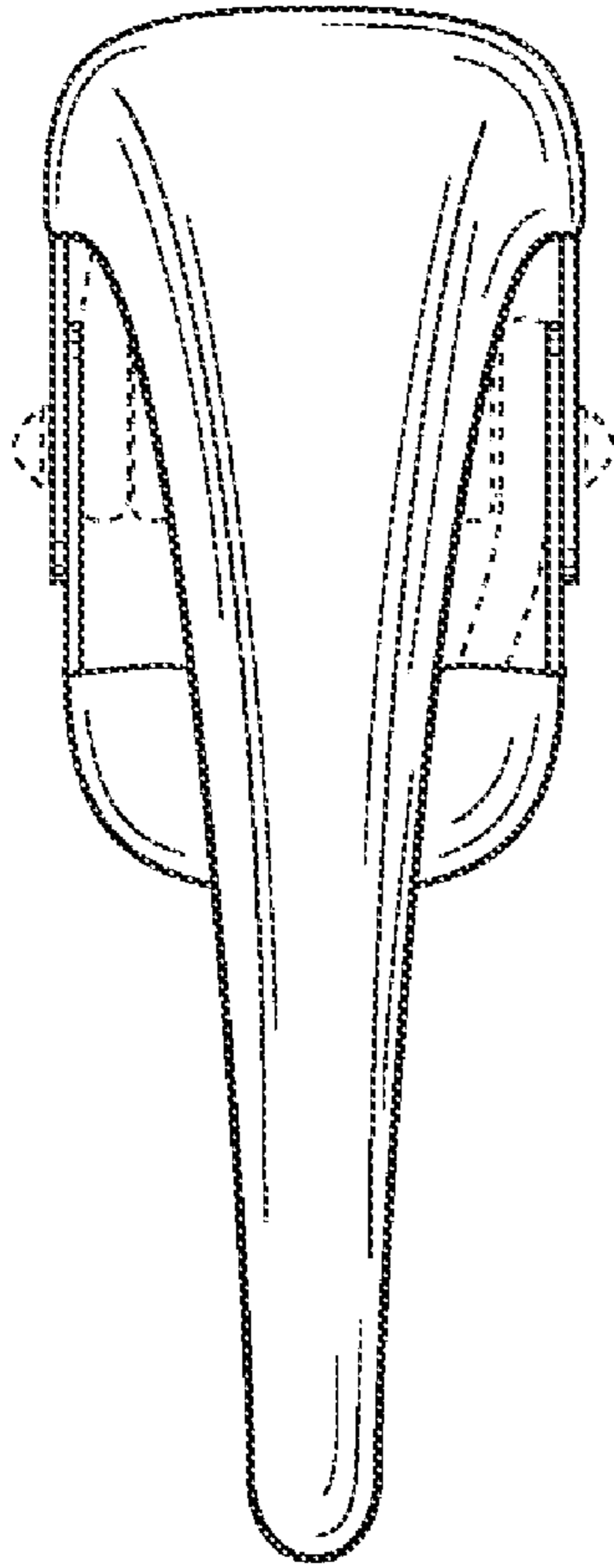

FIG. 14

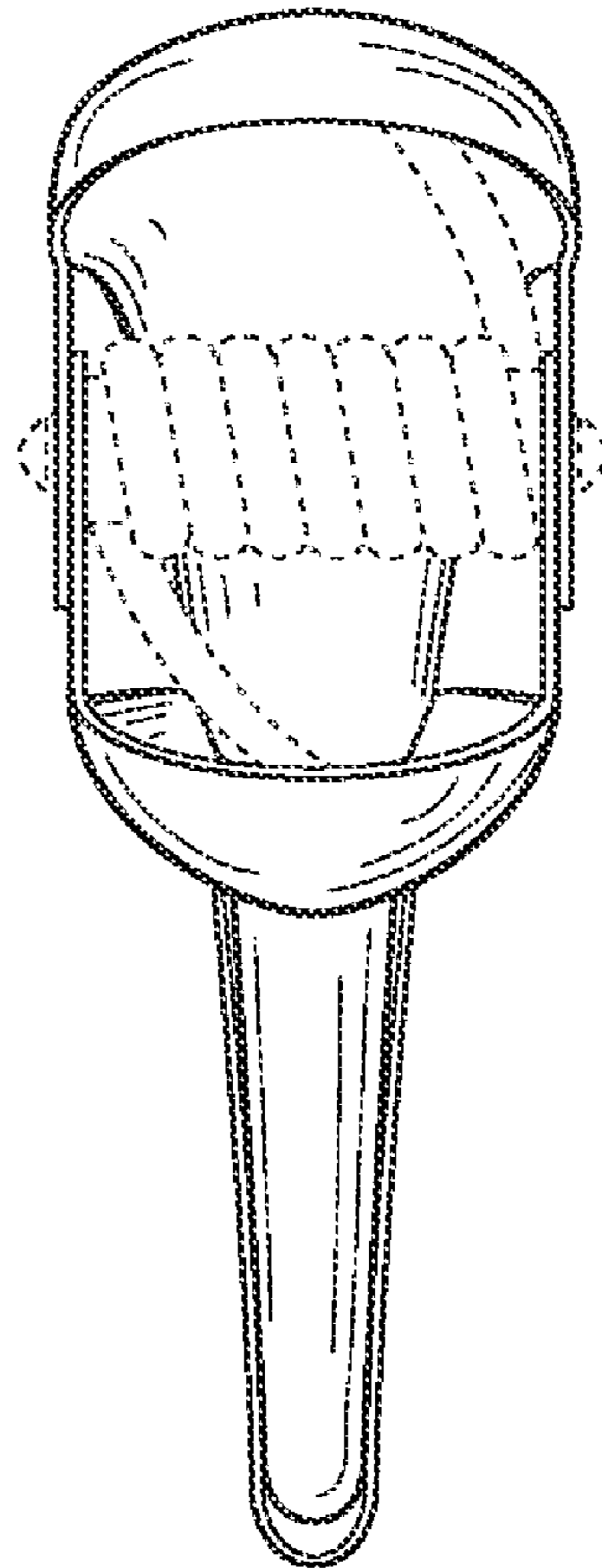

FIG. 15

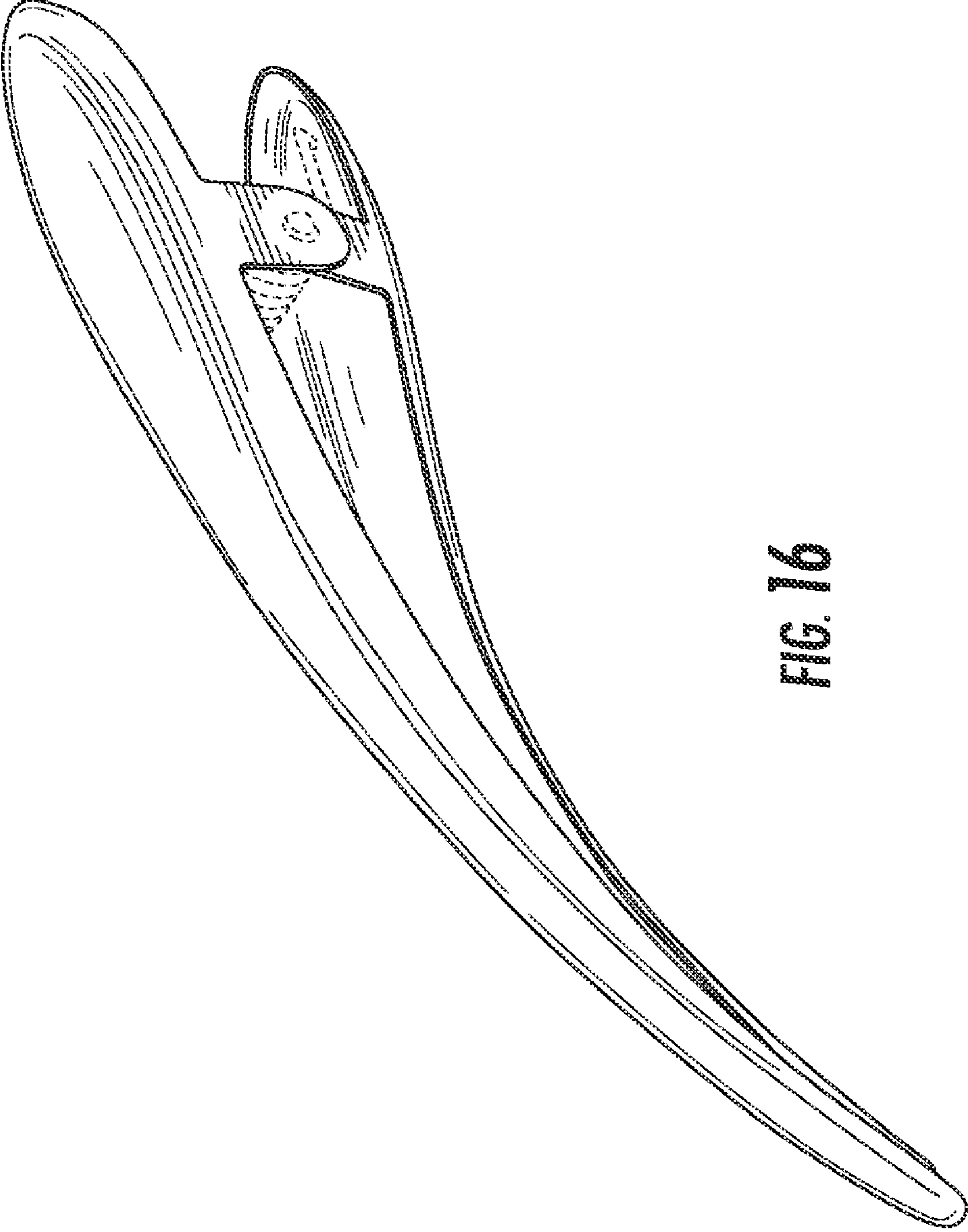

FIG. 16

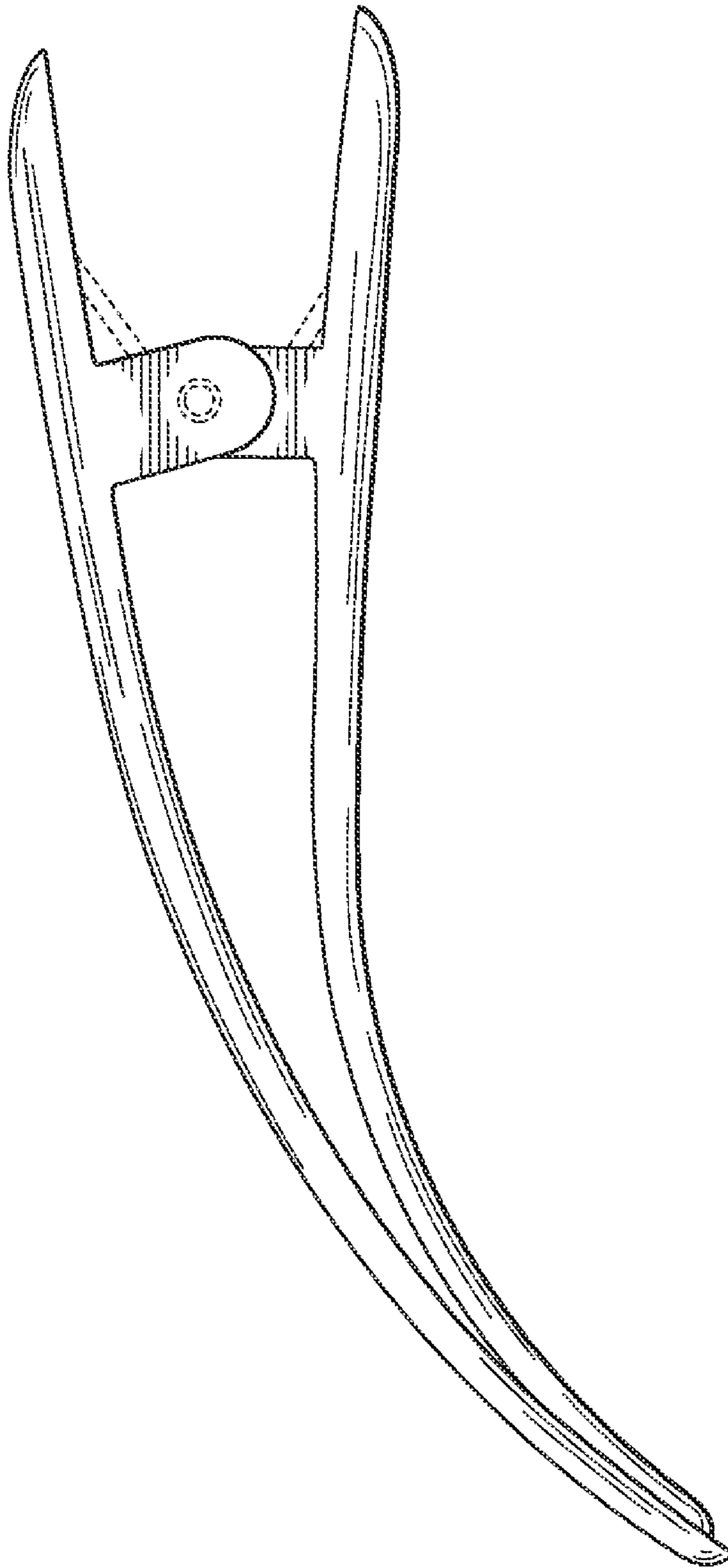

FIG. 17

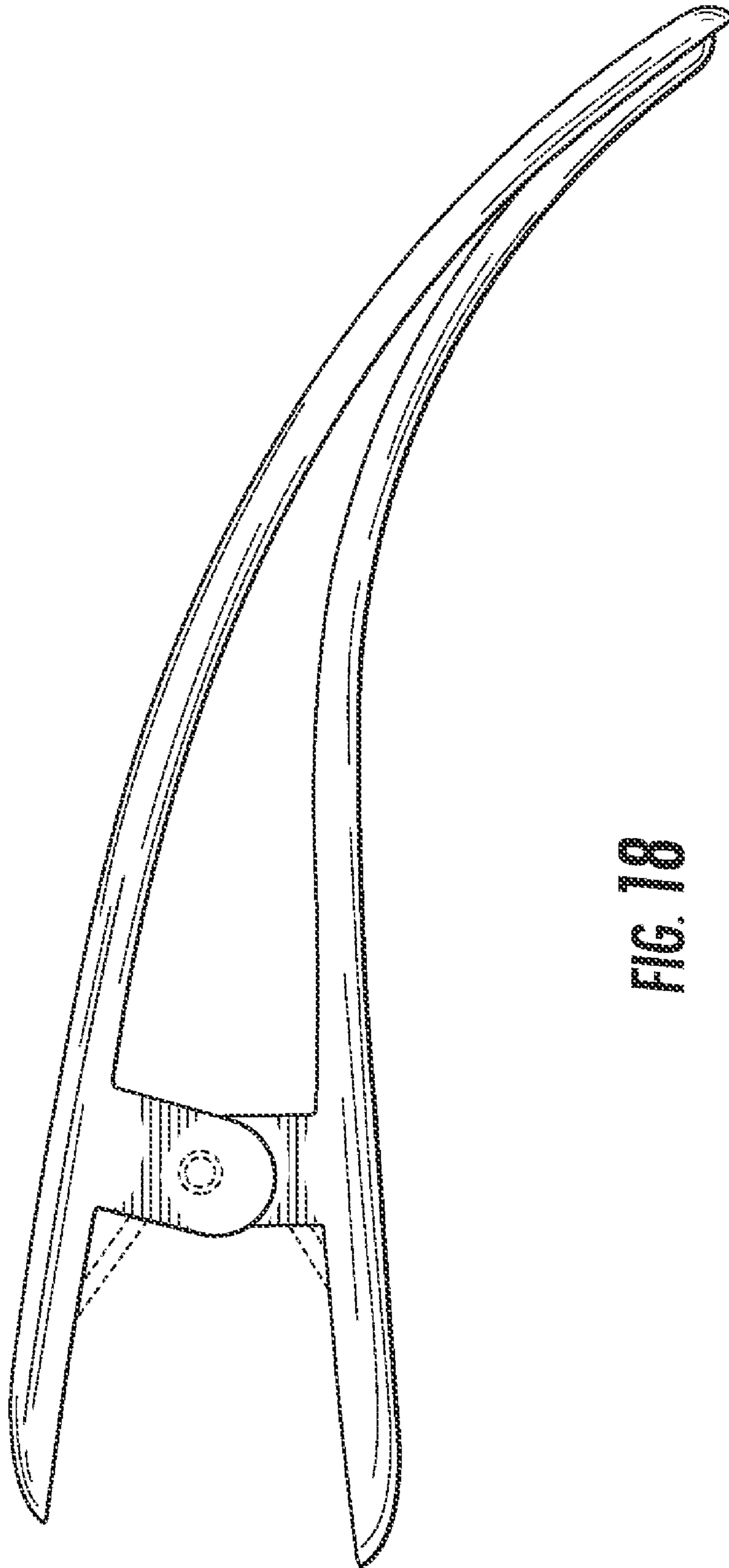

FIG. 18

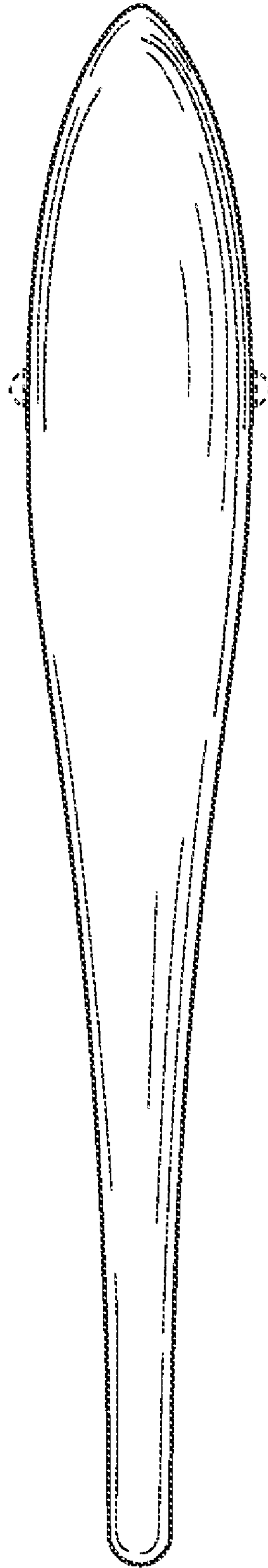

FIG. 19

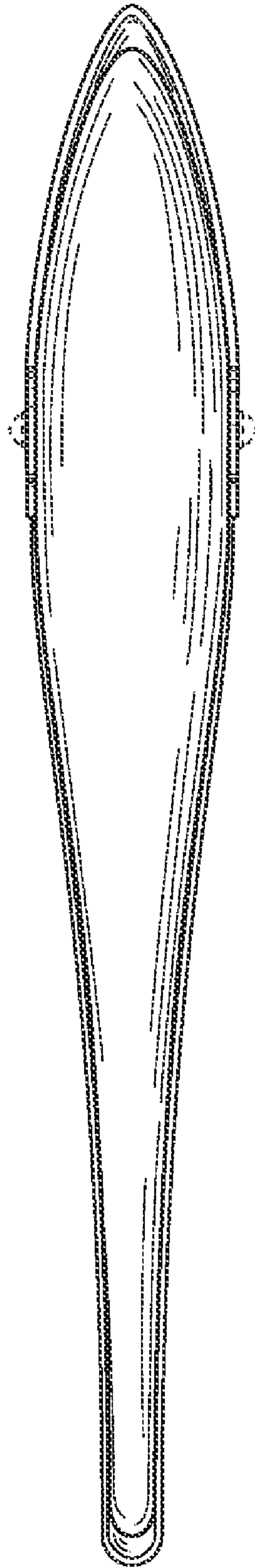

FIG. 20

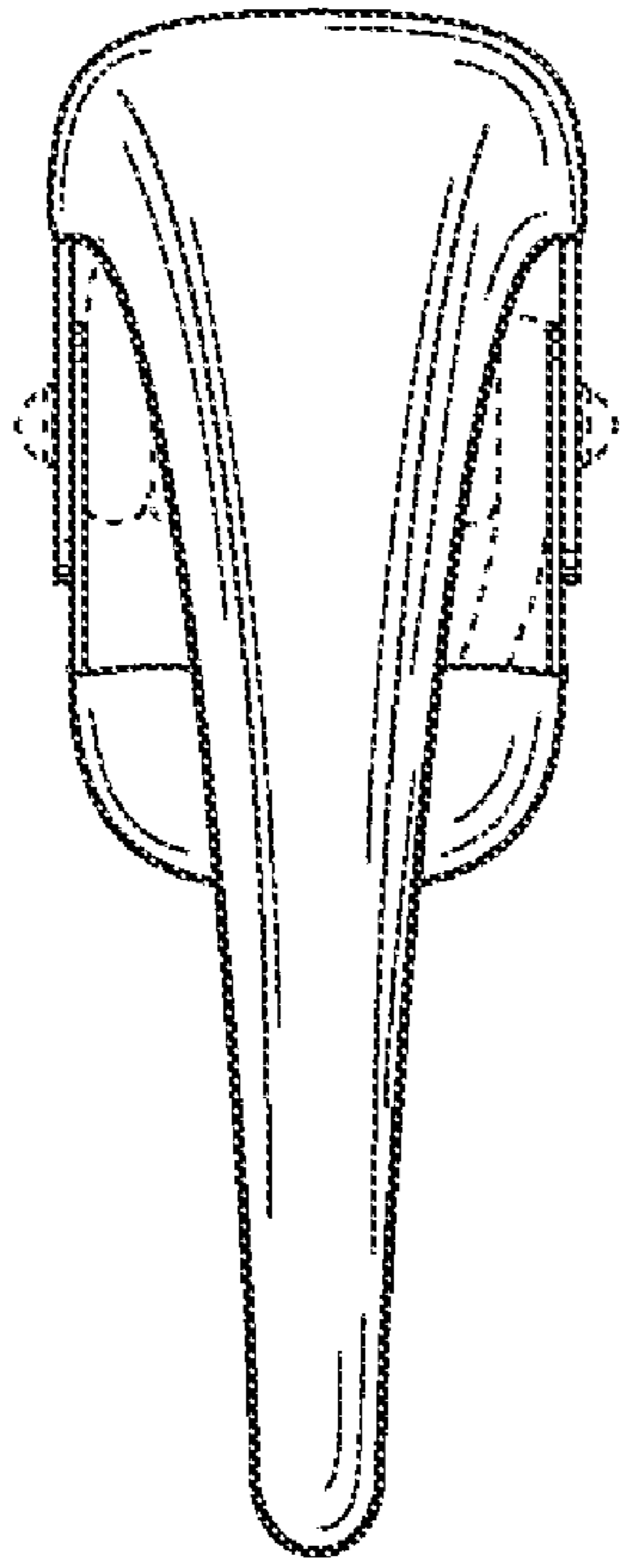

FIG. 21

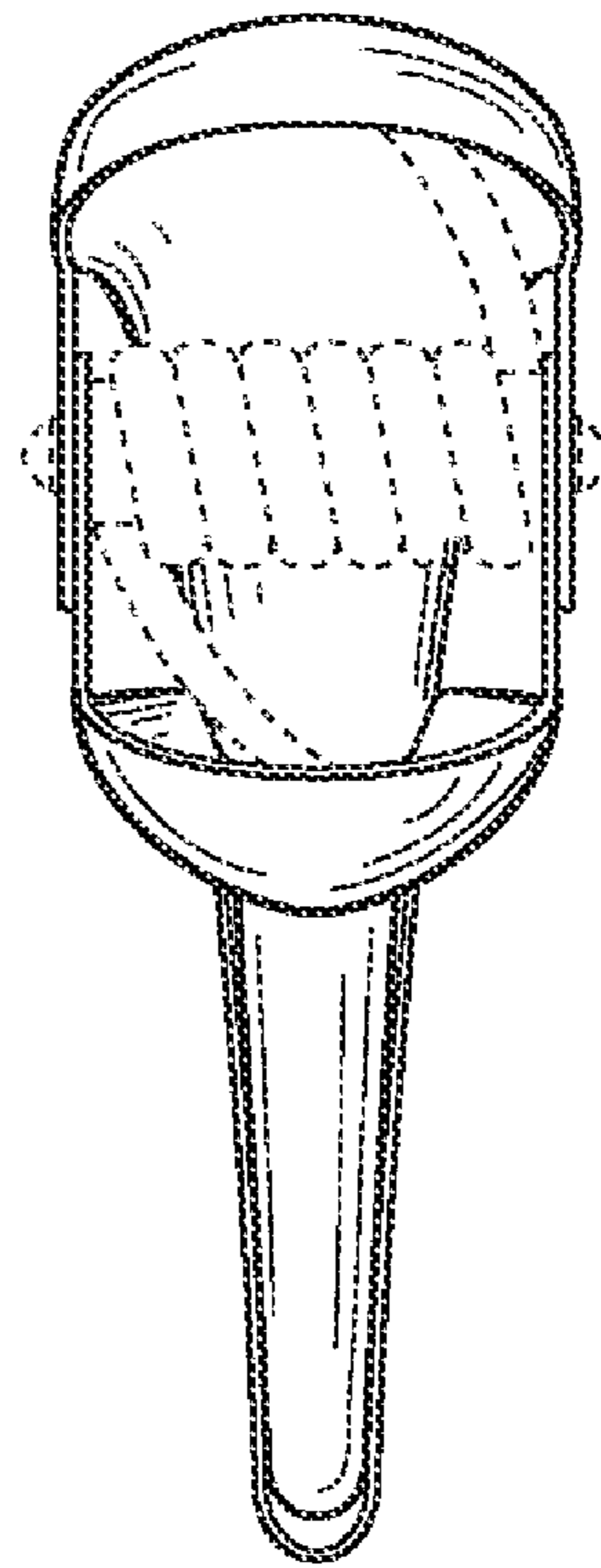

FIG. 22