



US00D586429S

(12) **United States Design Patent**
Fritz

(10) **Patent No.:** **US D586,429 S**
(45) **Date of Patent:** **** Feb. 10, 2009**

(54) **FAUCET**

D576,710 S * 9/2008 Fritz D23/238
D577,420 S * 9/2008 Corbett et al. D23/238
D581,030 S * 11/2008 Fritz D23/255

(75) Inventor: **Seth A. Fritz**, Indianapolis, IN (US)

(73) Assignee: **Masco Corporation of Indiana**,
Indianapolis, IN (US)

(**) Term: **14 Years**

* cited by examiner

Primary Examiner—Robert A Delehanty
(74) *Attorney, Agent, or Firm*—Leon E. Redman

(21) Appl. No.: **29/305,079**

(57) **CLAIM**

(22) Filed: **Mar. 13, 2008**

The ornamental design for a faucet, as shown and described.

(51) **LOC (9) Cl.** **23-01**

(52) **U.S. Cl.** **D23/238**

(58) **Field of Classification Search** D23/238–243,
D23/255–257; 4/675–678; 137/801; D8/300,
D8/307–308, 321; 16/110.1

See application file for complete search history.

DESCRIPTION

FIG. 1 is a front perspective view of a faucet showing my design;

FIG. 2 is a rear perspective view showing my design;

FIG. 3 is a right side elevational view thereof; the left side elevational view being a mirror image thereof;

FIG. 4 is a top plan view thereof;

FIG. 5 is a front elevational view thereof; and,

FIG. 6 is a rear elevational view thereof.

(56) **References Cited**

U.S. PATENT DOCUMENTS

D326,504 S * 5/1992 Robbins D23/255
D511,811 S * 11/2005 Lord D23/238
D550,331 S * 9/2007 Soriano D23/255

1 Claim, 4 Drawing Sheets

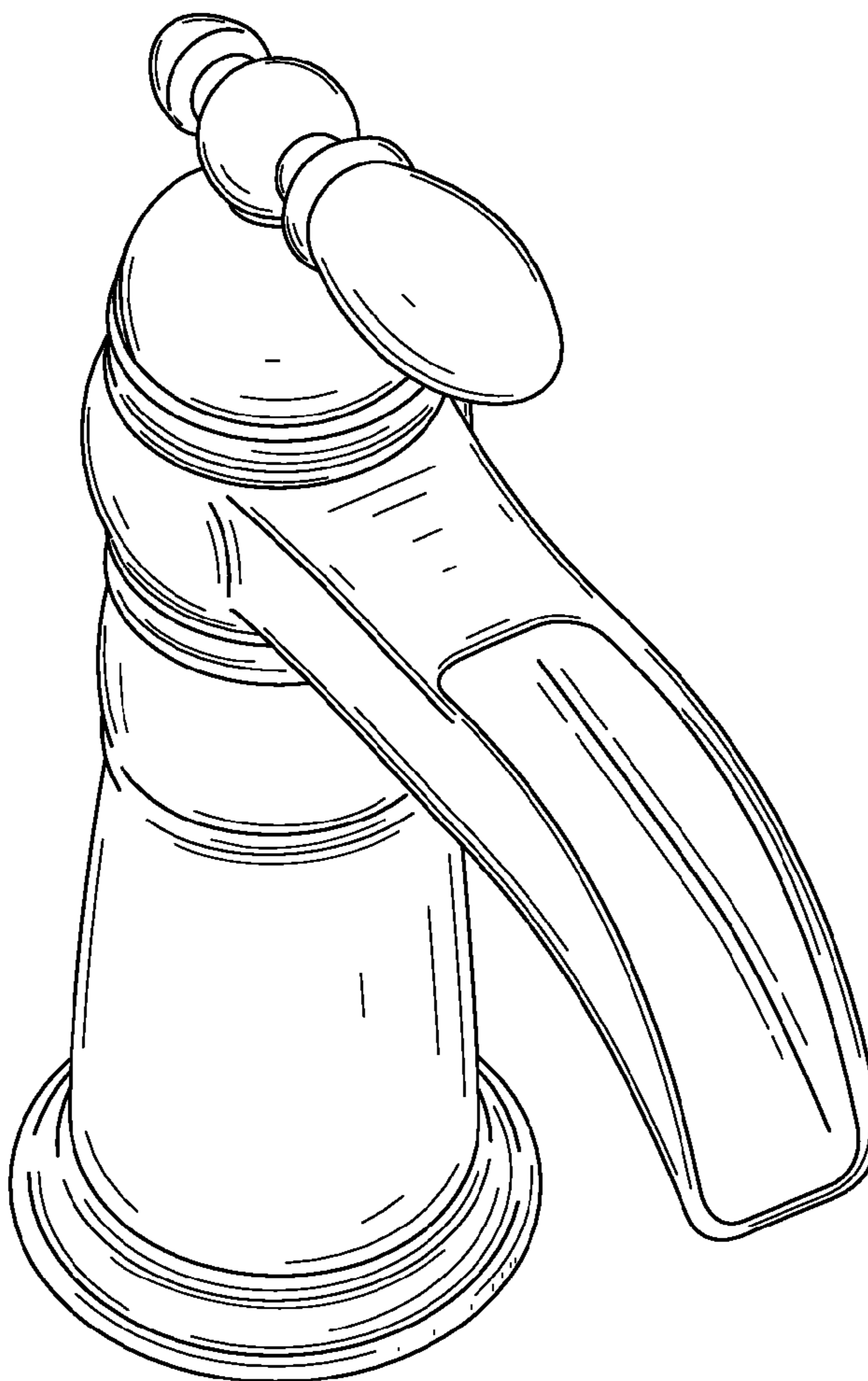

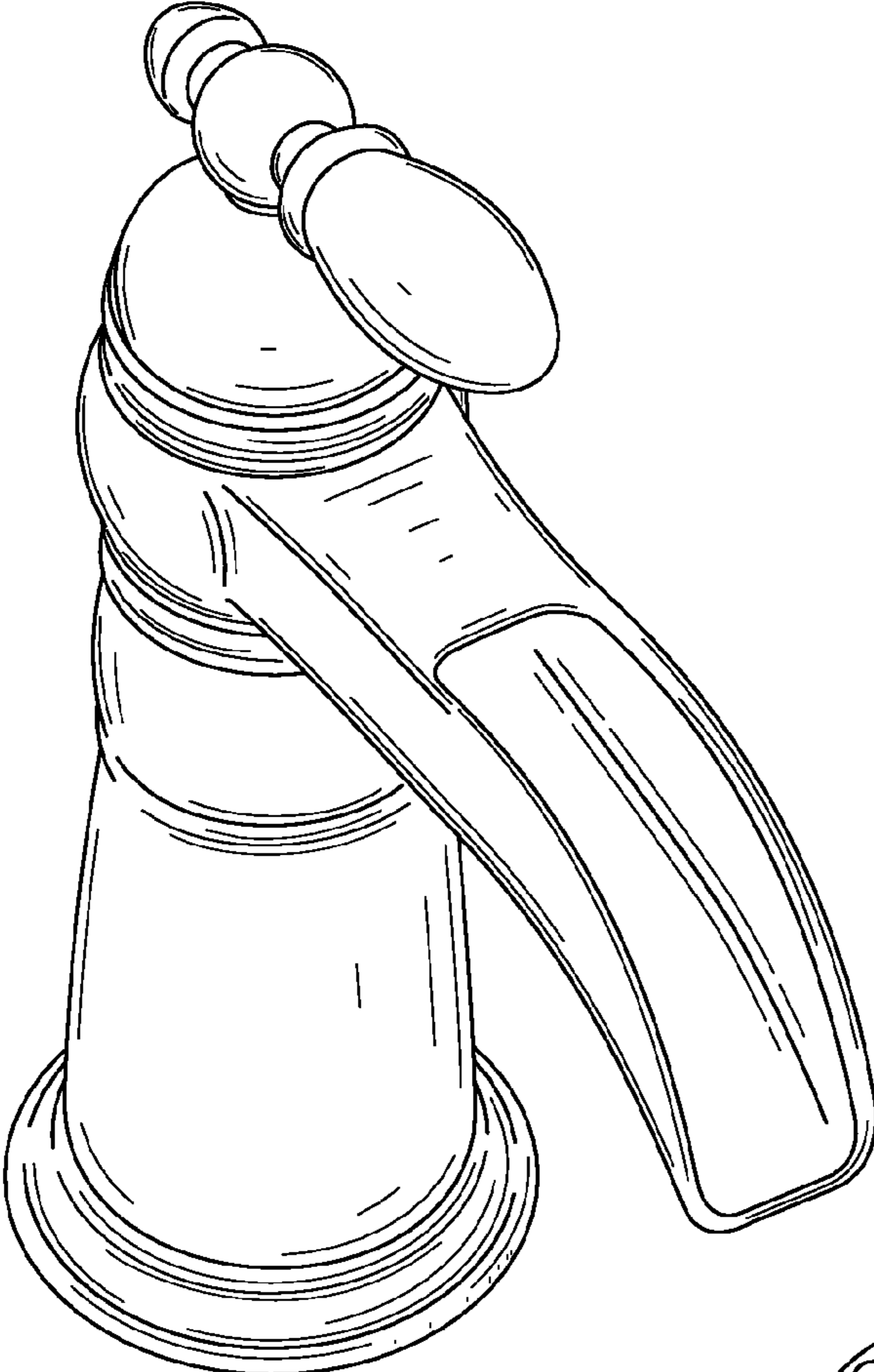

FIG. 1

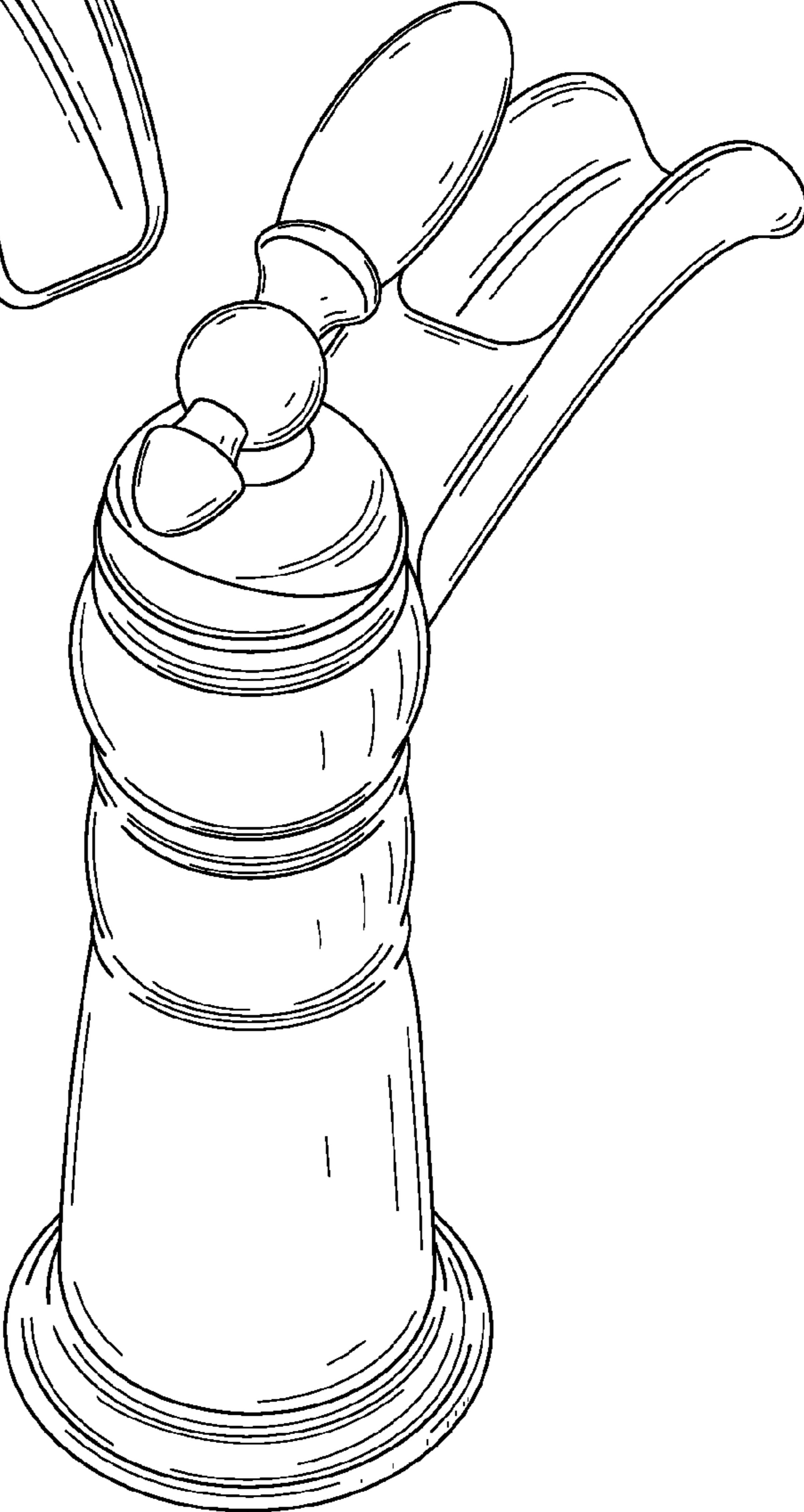

FIG. 2

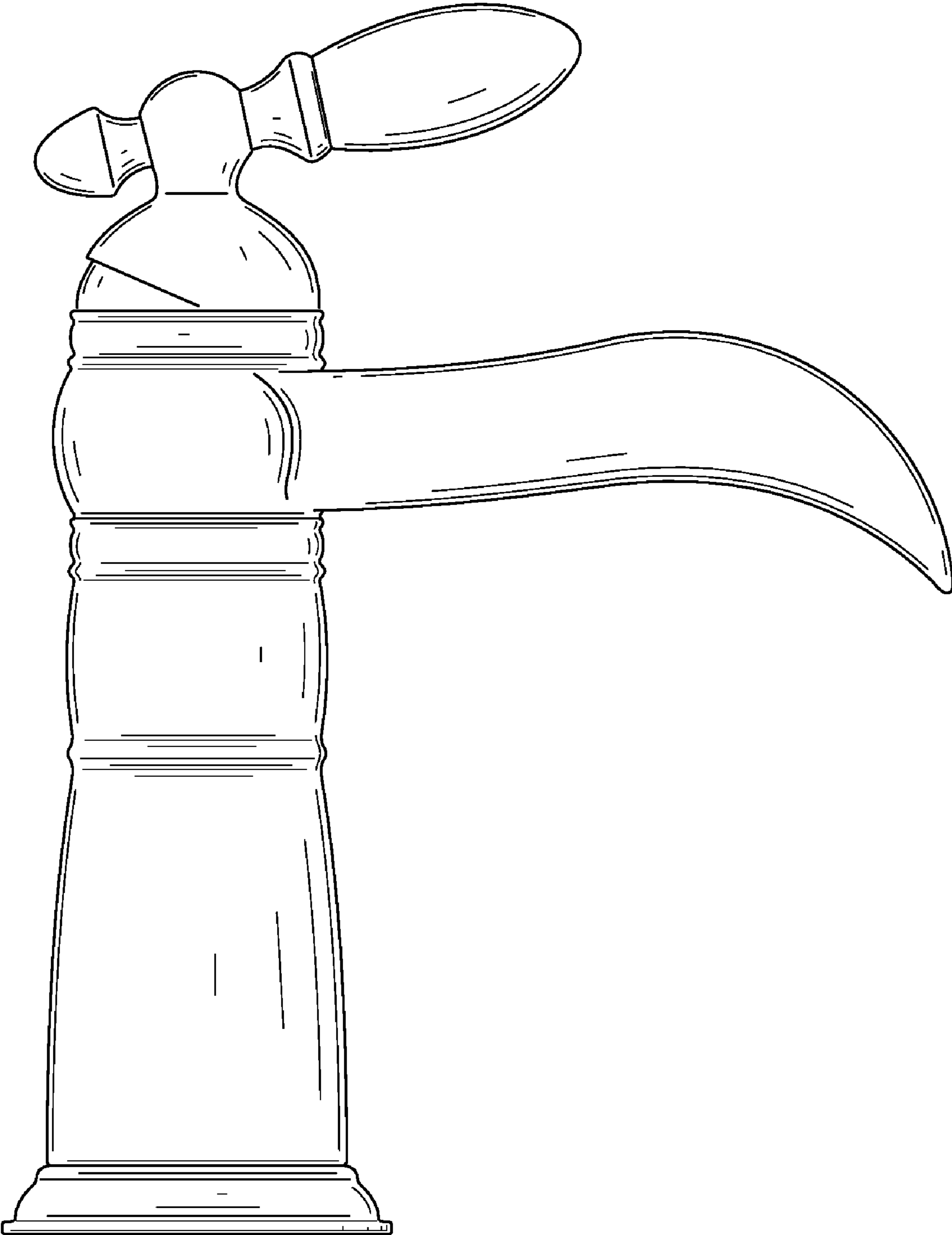

FIG. 3

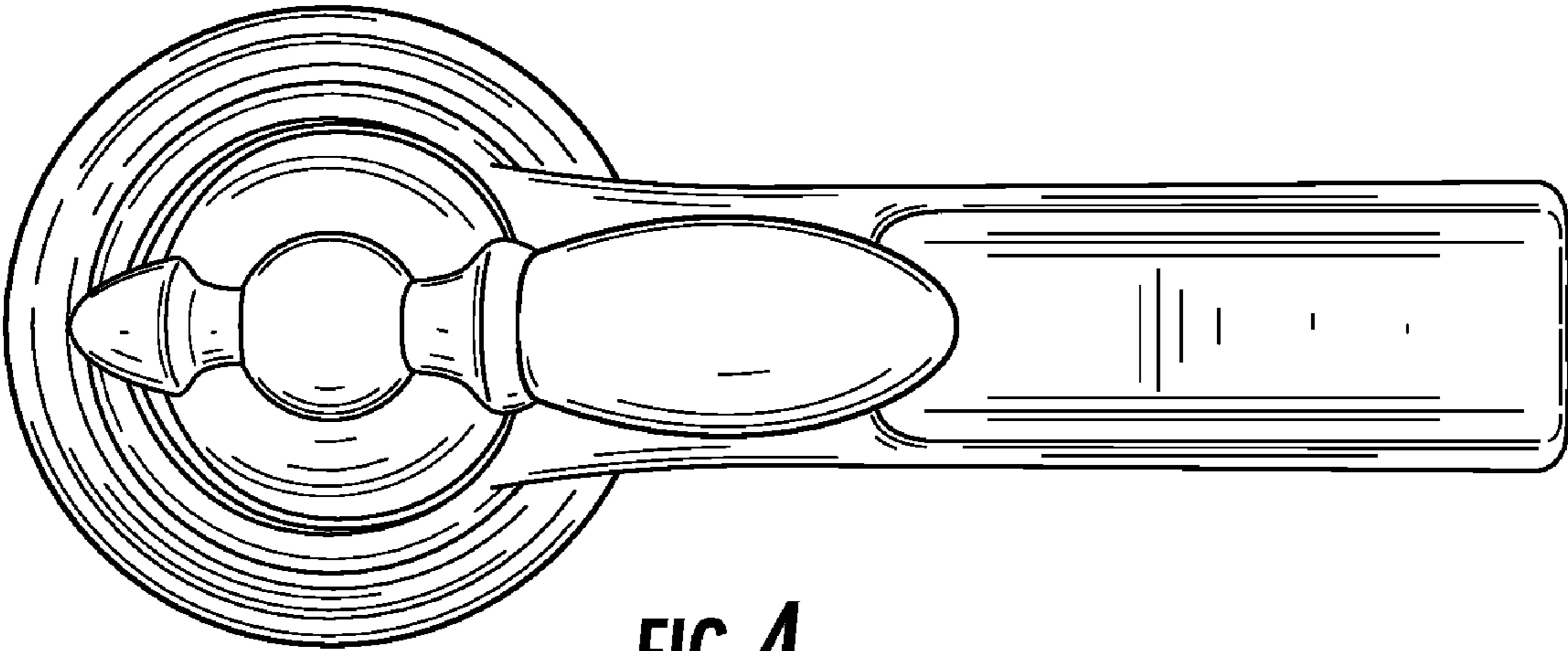

FIG. 4

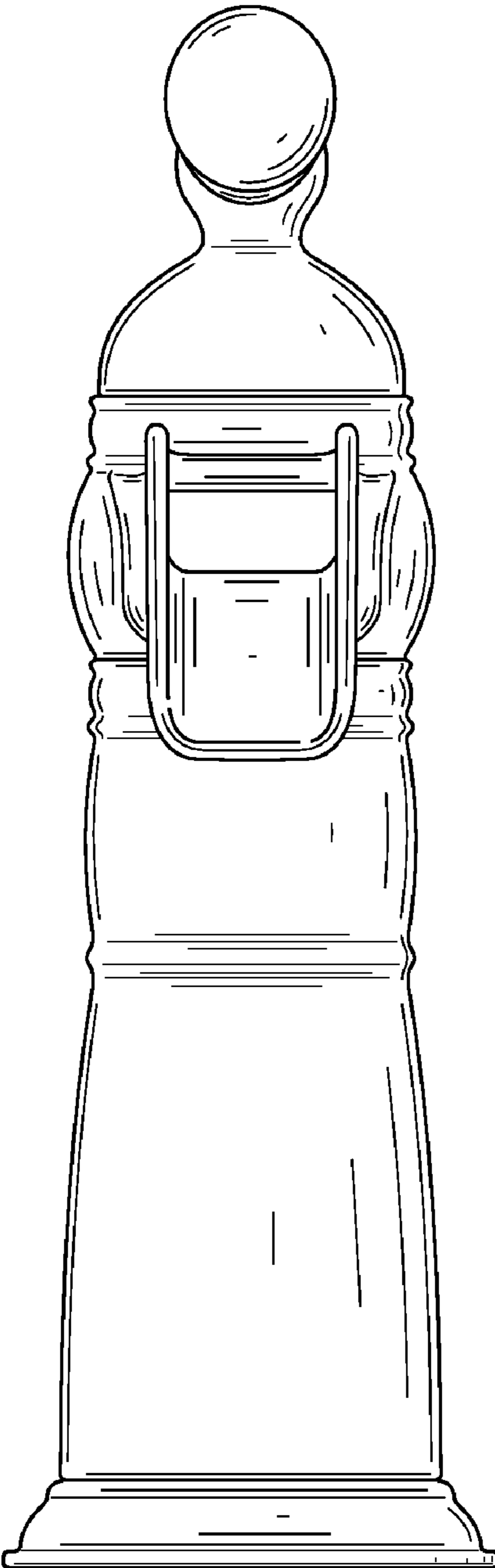

FIG. 5

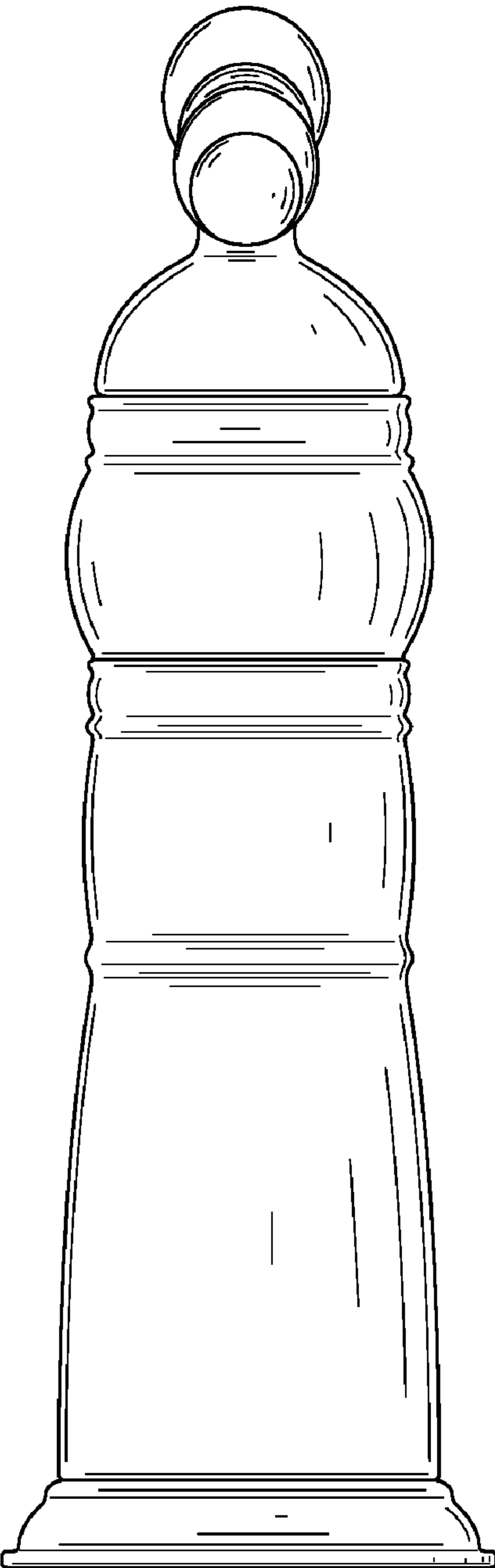

FIG. 6