



US00D586426S

(12) **United States Design Patent**  
**Schoenherr et al.**

(10) **Patent No.:** **US D586,426 S**  
(45) **Date of Patent:** **\*\* Feb. 10, 2009**

(54) **SHOWERHEAD**

Nikles Inter AG—Spot Model 3805QM, 2006.

(75) Inventors: **Tom Schoenherr**, Stuttgart (DE);  
**Fabian Kollmann**, Stuttgart (DE)

\* cited by examiner

(73) Assignee: **Hansgrohe AG**, Schiltach (DE)

*Primary Examiner*—Robin V Webster

(74) *Attorney, Agent, or Firm*—Leon E. Redman

(\*\*) Term: **14 Years**

(57) **CLAIM**

(21) Appl. No.: **29/304,188**

The ornamental design for a showerhead, as shown and described.

(22) Filed: **Feb. 27, 2008**

(30) **Foreign Application Priority Data**

**DESCRIPTION**

Jan. 24, 2008 (EM) ..... 000865480-0003

(51) **LOC (9) Cl.** ..... **23-01**

FIG. 1 is a front perspective view of a showerhead showing our design;

(52) **U.S. Cl.** ..... **D23/213; D23/229**

FIG. 2 is a front elevational view thereof;

(58) **Field of Classification Search** ..... D23/213,  
D23/223, 226, 229–230; 239/282–283, 462  
See application file for complete search history.

FIG. 3 is a rear elevational view thereof;

FIG. 4 is a left side elevational view thereof;

(56) **References Cited**

FIG. 5 is a right side elevational view thereof;

**U.S. PATENT DOCUMENTS**

FIG. 6 is a top plan view thereof; and,

D443,025 S \* 5/2001 Kollmann et al. .... D23/229

FIG. 7 is a bottom plan view thereof.

D529,987 S \* 10/2006 Tse ..... D23/213

D530,390 S \* 10/2006 Tse ..... D23/213

The broken lines in the Figures are for illustrative purposes only and form no part of the claimed design.

**OTHER PUBLICATIONS**

Fornara & Maulini—Orchidea shower-head, 2005.

Nikles Inter AG—Lux Model 4005QA, 2006.

**1 Claim, 7 Drawing Sheets**

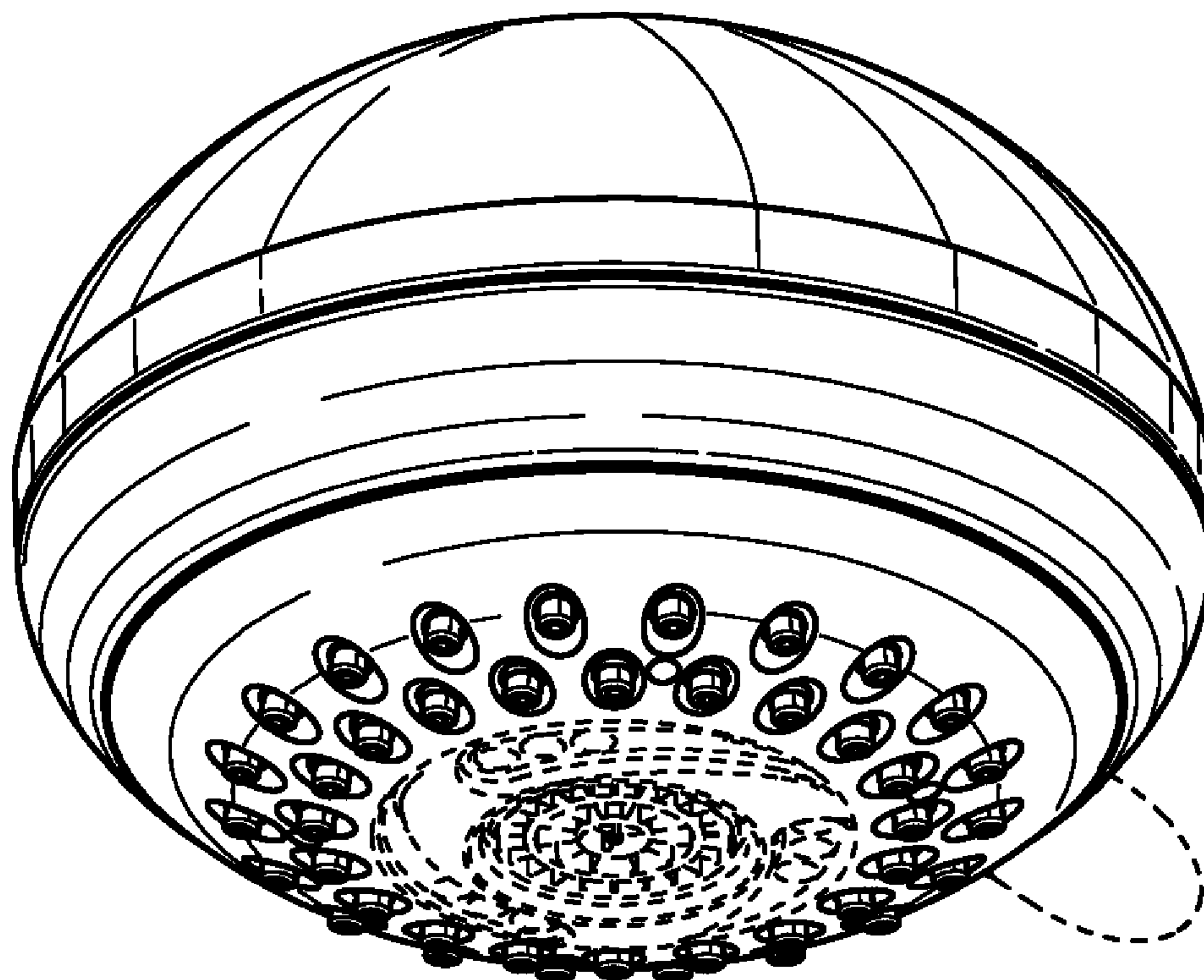

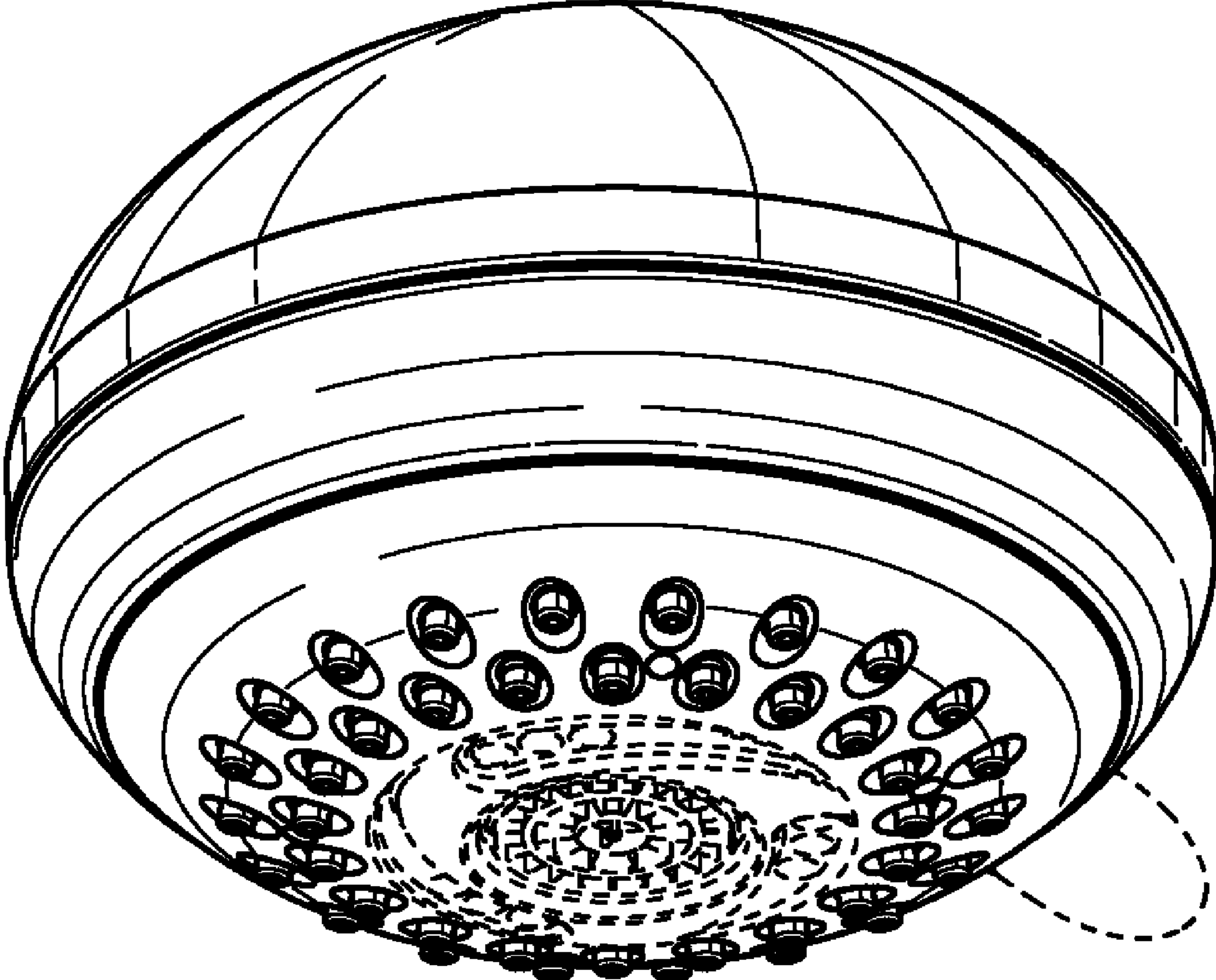

FIG. 1

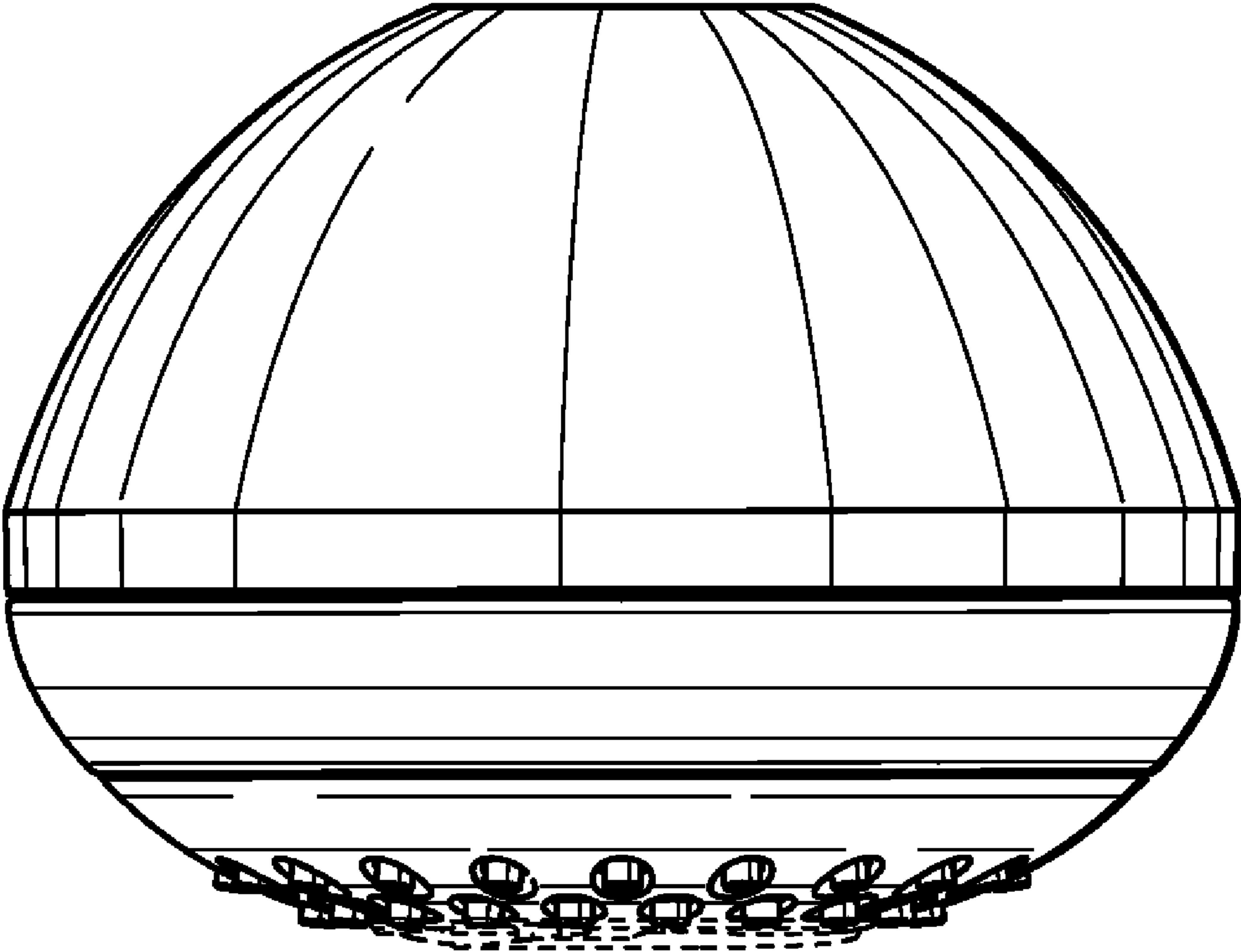

FIG. 2

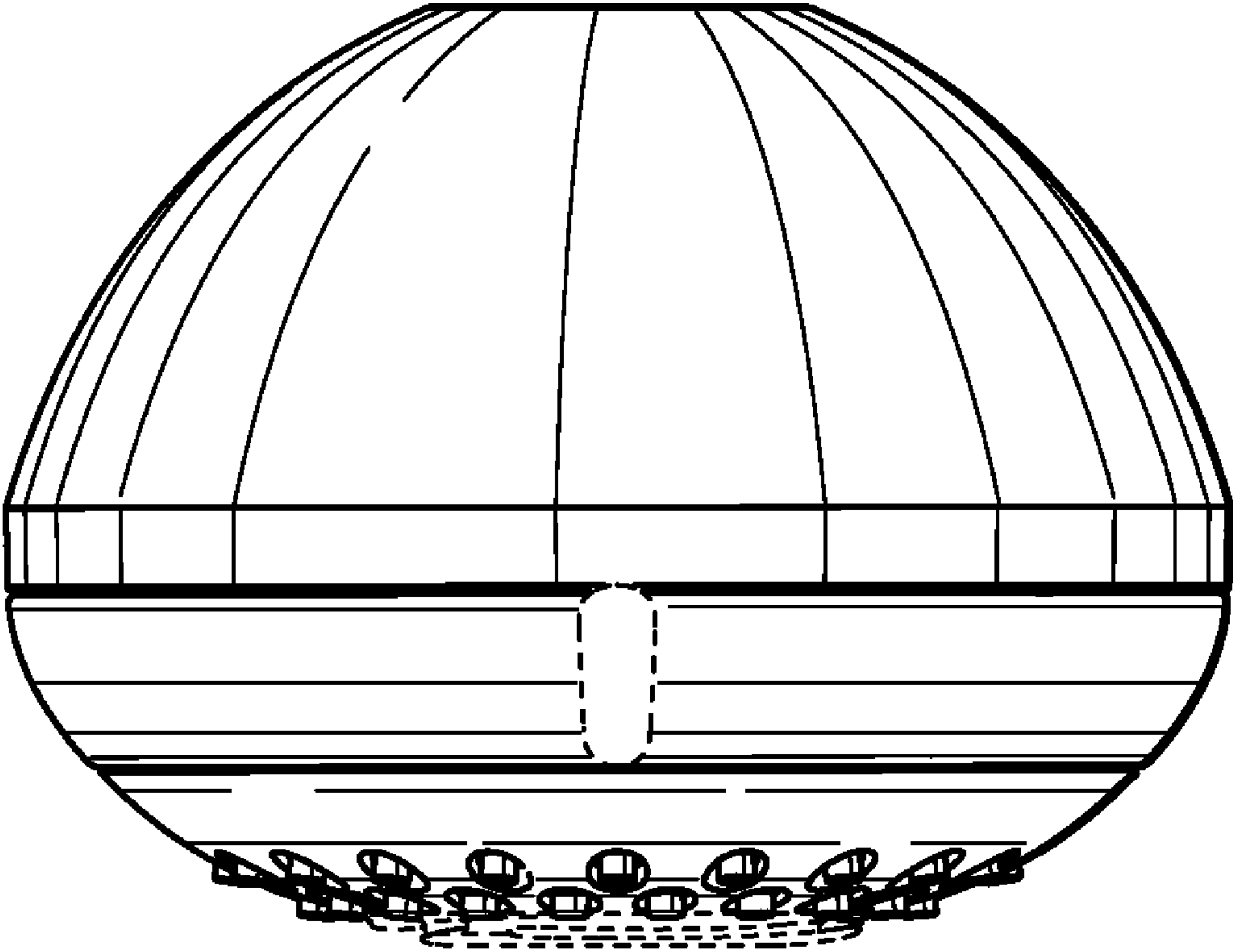

FIG. 3

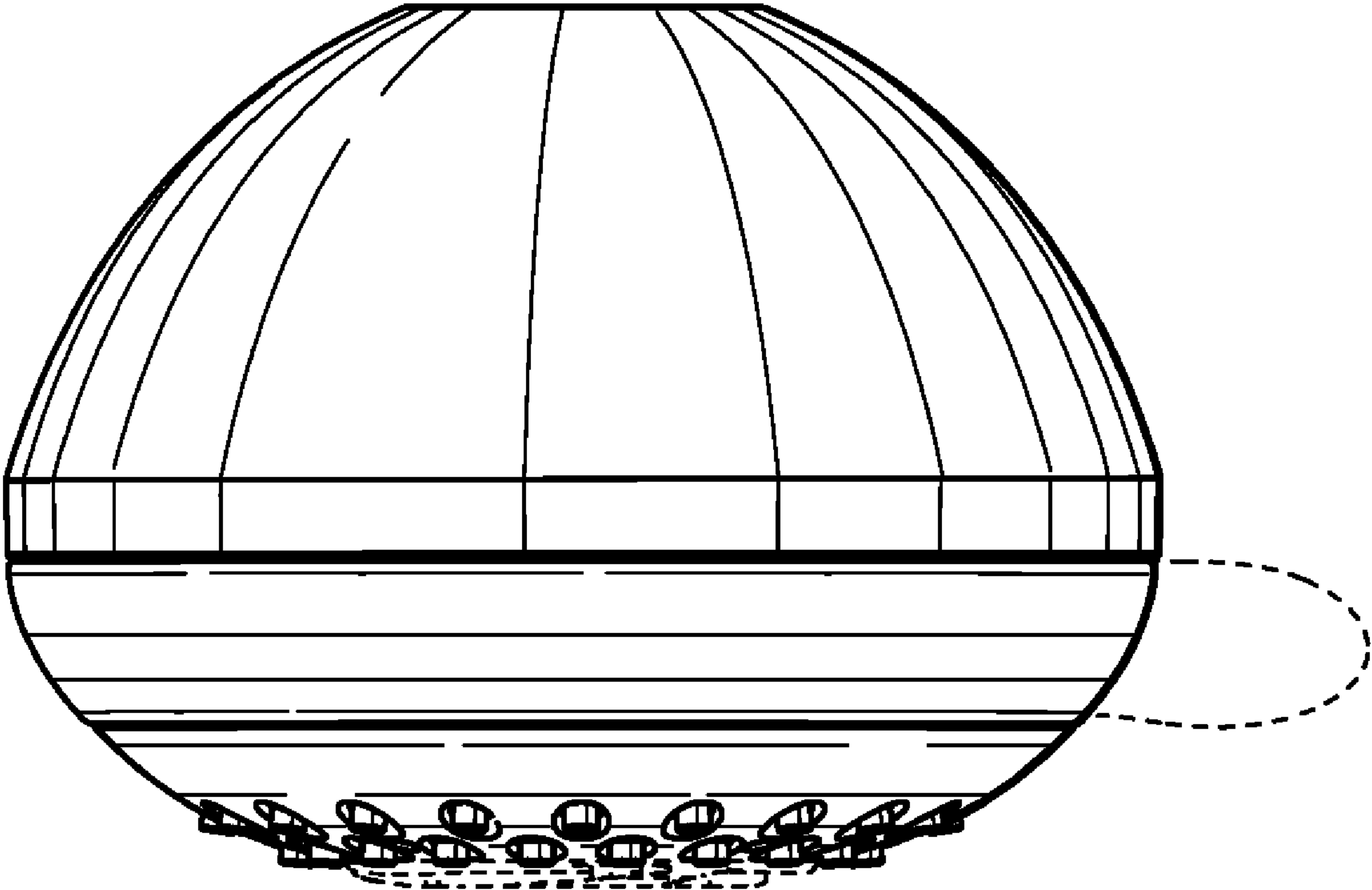

FIG. 4

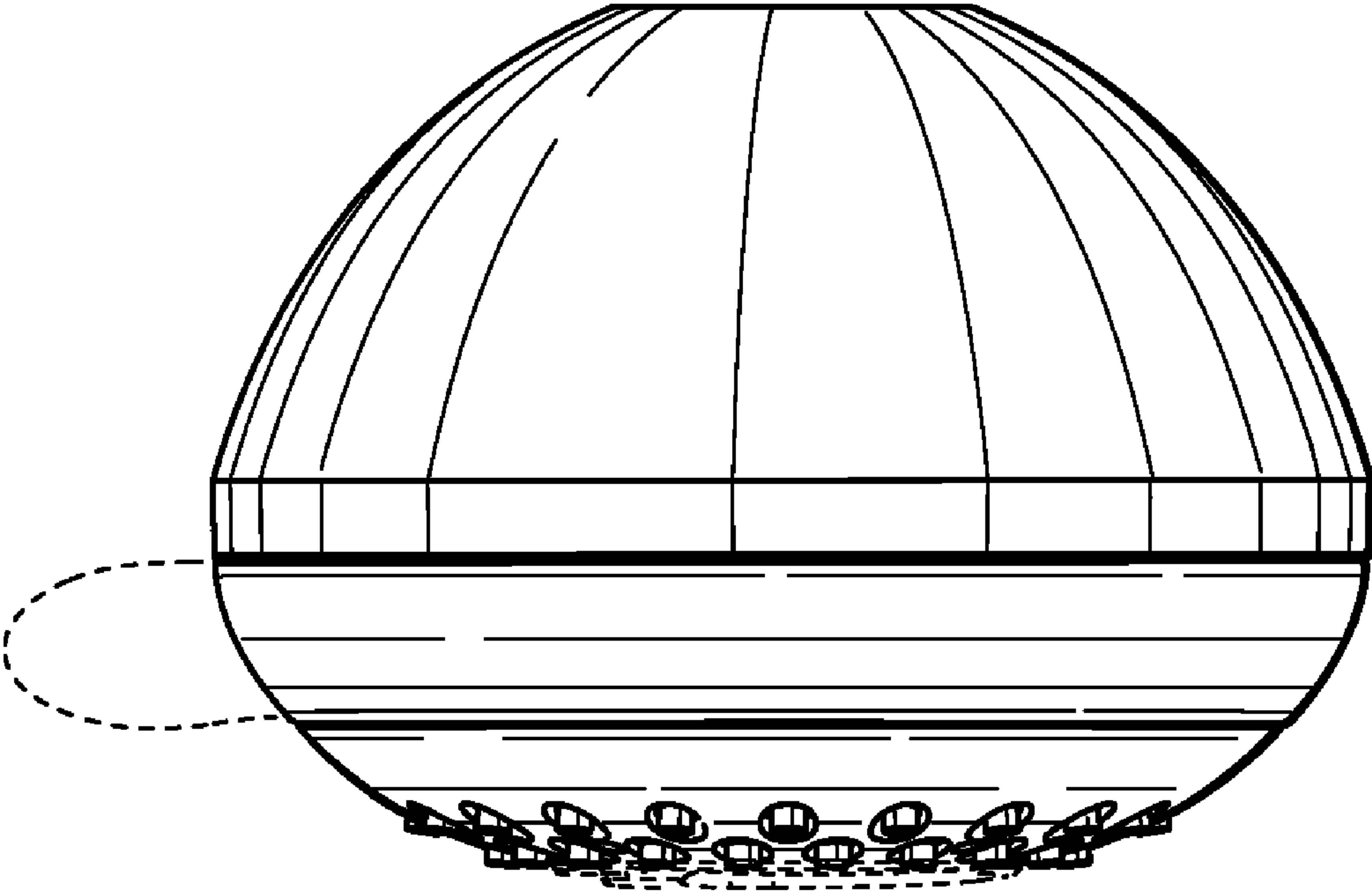

FIG. 5

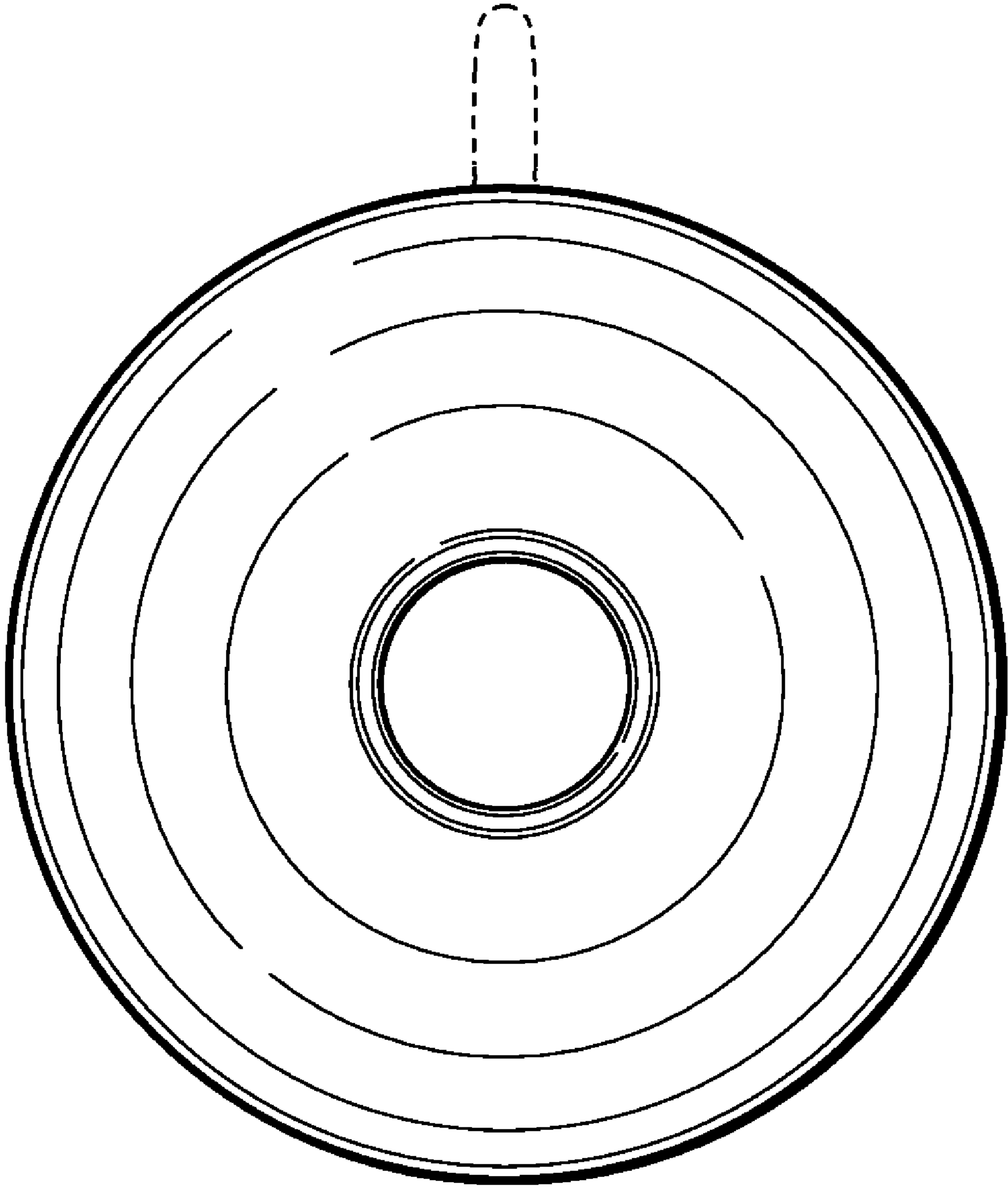

FIG. 6



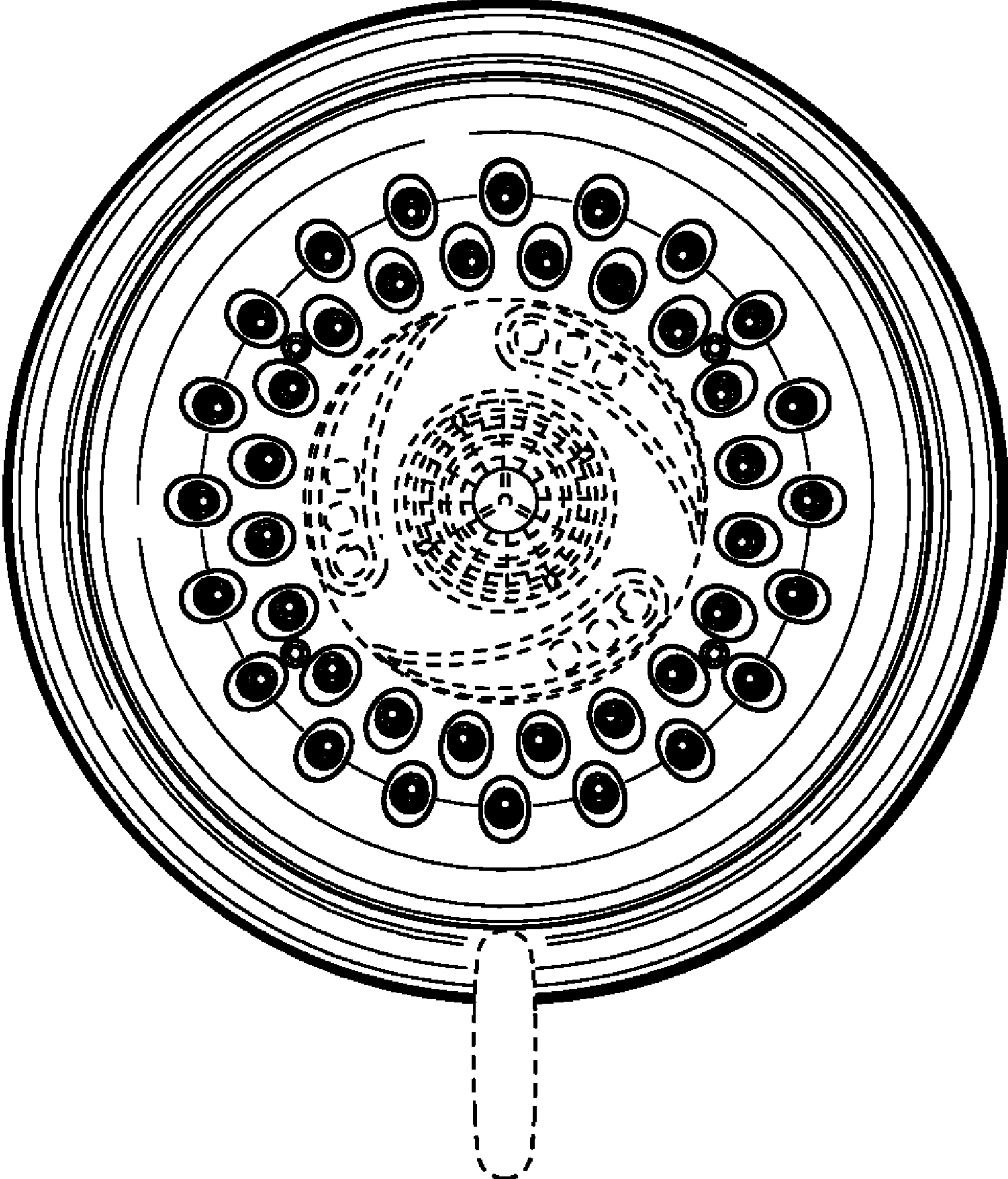

FIG. 7