

US00D586410S

(12) **United States Design Patent**  
**Citterio**

(10) **Patent No.:** **US D586,410 S**

(45) **Date of Patent:** **\*\* Feb. 10, 2009**

(54) **GYMNASTIC MACHINE**

(57) **CLAIM**

(75) Inventor: **Antonio Citterio**, Milan (IT)

The ornamental design of a gymnastic machine, as shown and described.

(73) Assignee: **Technogym S.p.A.**, Gambettola (IT)

(\*\*) Term: **14 Years**

**DESCRIPTION**

(21) Appl. No.: **29/285,695**

FIG. 1 shows a bottom view of a gymnastic machine according to our new design in a first configuration;

(22) Filed: **Apr. 5, 2007**

FIG. 2 shows a front view of the gymnastic machine shown in FIG. 1;

(51) **LOC (9) Cl.** ..... **21-02**

FIG. 3 shows a top view of the gymnastic machine shown in FIG. 1;

(52) **U.S. Cl.** ..... **D21/673**

FIG. 4 shows a righthand side view of the gymnastic machine shown in FIG. 1;

(58) **Field of Classification Search** ..... D21/674,  
D21/675, 676, 673; 482/99, 100, 101, 102,  
482/103, 133, 136, 138

FIG. 5 shows a rear view of the gymnastic machine shown in FIG. 1;

See application file for complete search history.

FIG. 6 shows a lefthand side view of the gymnastic machine shown in FIG. 1;

(56) **References Cited**

**U.S. PATENT DOCUMENTS**

5,102,122	A *	4/1992	Piane et al.	482/133
6,217,493	B1 *	4/2001	Spletzer	482/103
6,296,594	B1 *	10/2001	Simonson	482/79
6,443,877	B1 *	9/2002	Hoecht et al.	482/103
6,447,430	B1 *	9/2002	Webb et al.	482/98
6,458,061	B2 *	10/2002	Simonson	482/103
6,527,683	B2 *	3/2003	Tolles	482/99
6,565,490	B2 *	5/2003	O'Hearn	482/102
6,770,015	B2 *	8/2004	Simonson	482/99
7,169,093	B2 *	1/2007	Simonson et al.	482/103
7,179,209	B2 *	2/2007	Sechrest et al.	482/103
2003/0017918	A1 *	1/2003	Webb et al.	482/94
2003/0045406	A1 *	3/2003	Stone	482/100

FIG. 7 shows a perspective view of the gymnastic machine shown in FIG. 1;

FIG. 8 shows a bottom view of the gymnastic machine according to our new design in a second configuration;

FIG. 9 shows a front view of the gymnastic machine shown in FIG. 8;

FIG. 10 shows a top view of the gymnastic machine shown in FIG. 8;

FIG. 11 shows a righthand side view of the gymnastic machine shown in FIG. 8;

FIG. 12 shows a rear view of the gymnastic machine shown in FIG. 8;

FIG. 13 shows a lefthand side view of the gymnastic machine shown in FIG. 8; and,

FIG. 14 shows a perspective view of the gymnastic machine shown in FIG. 8.

\* cited by examiner

*Primary Examiner*—Philip S Hyder

(74) *Attorney, Agent, or Firm*—Abelman, Frayne & Schwab

**1 Claim, 14 Drawing Sheets**

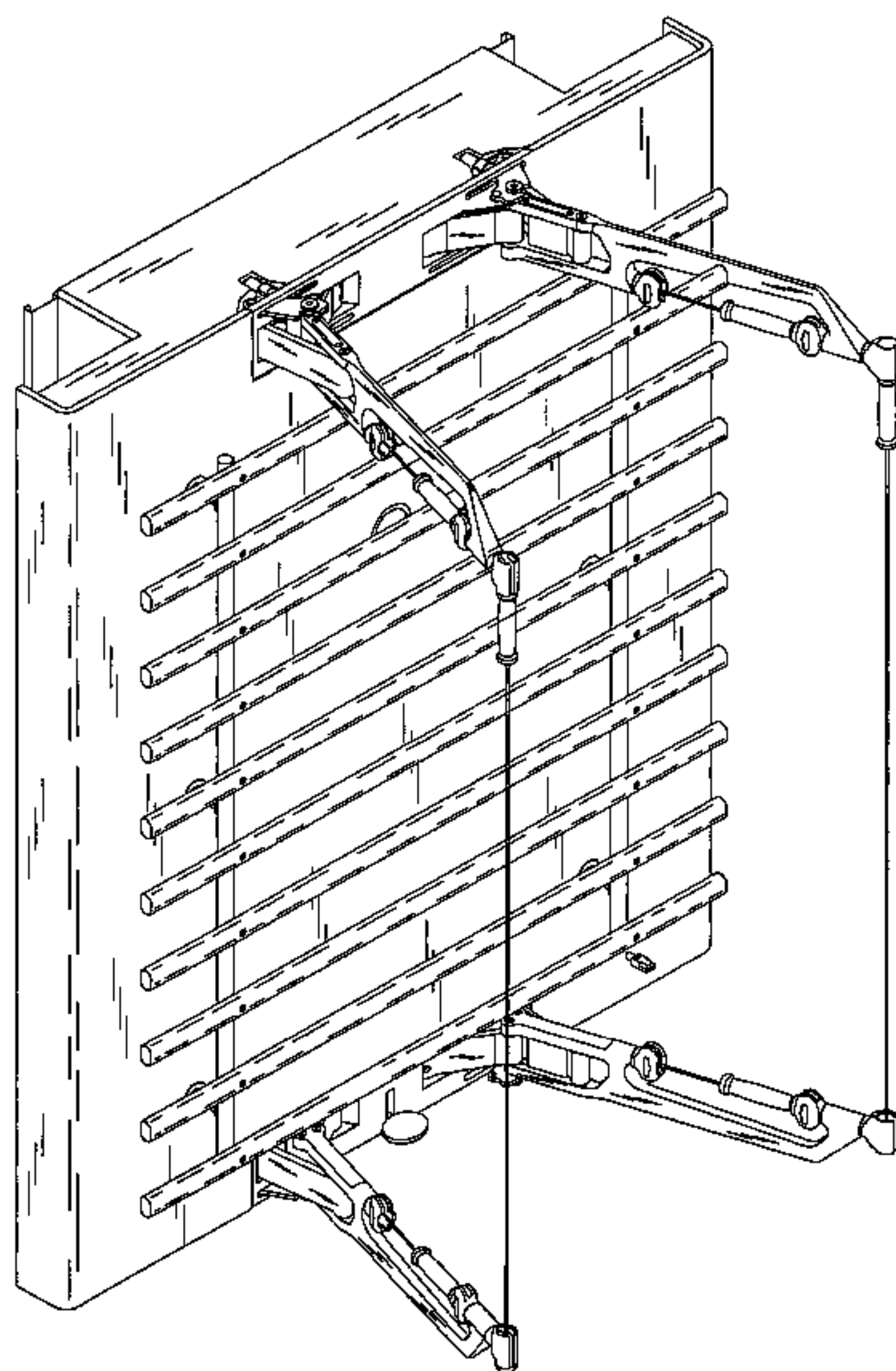

Fig. 1

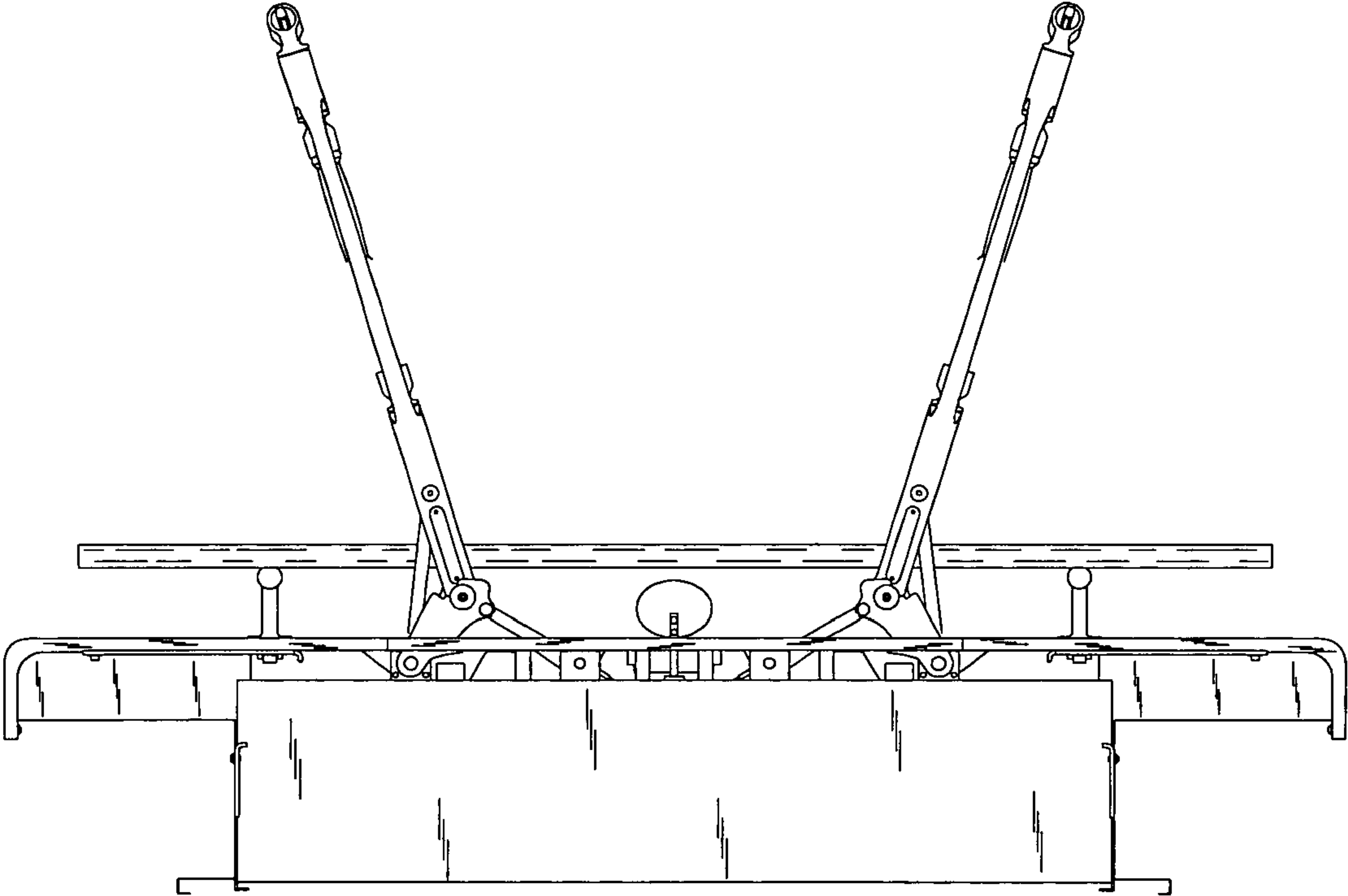

Fig. 2

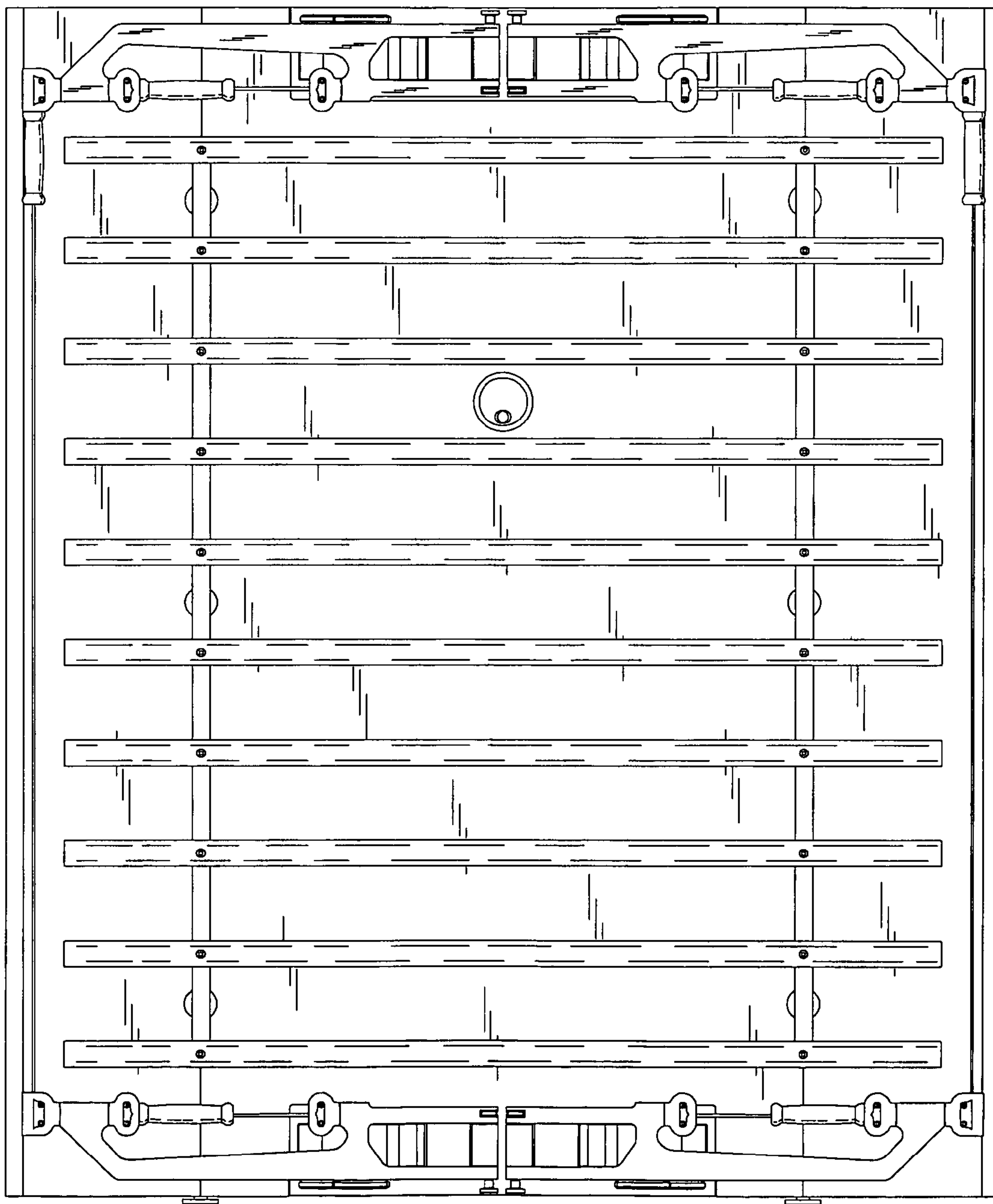

Fig. 3

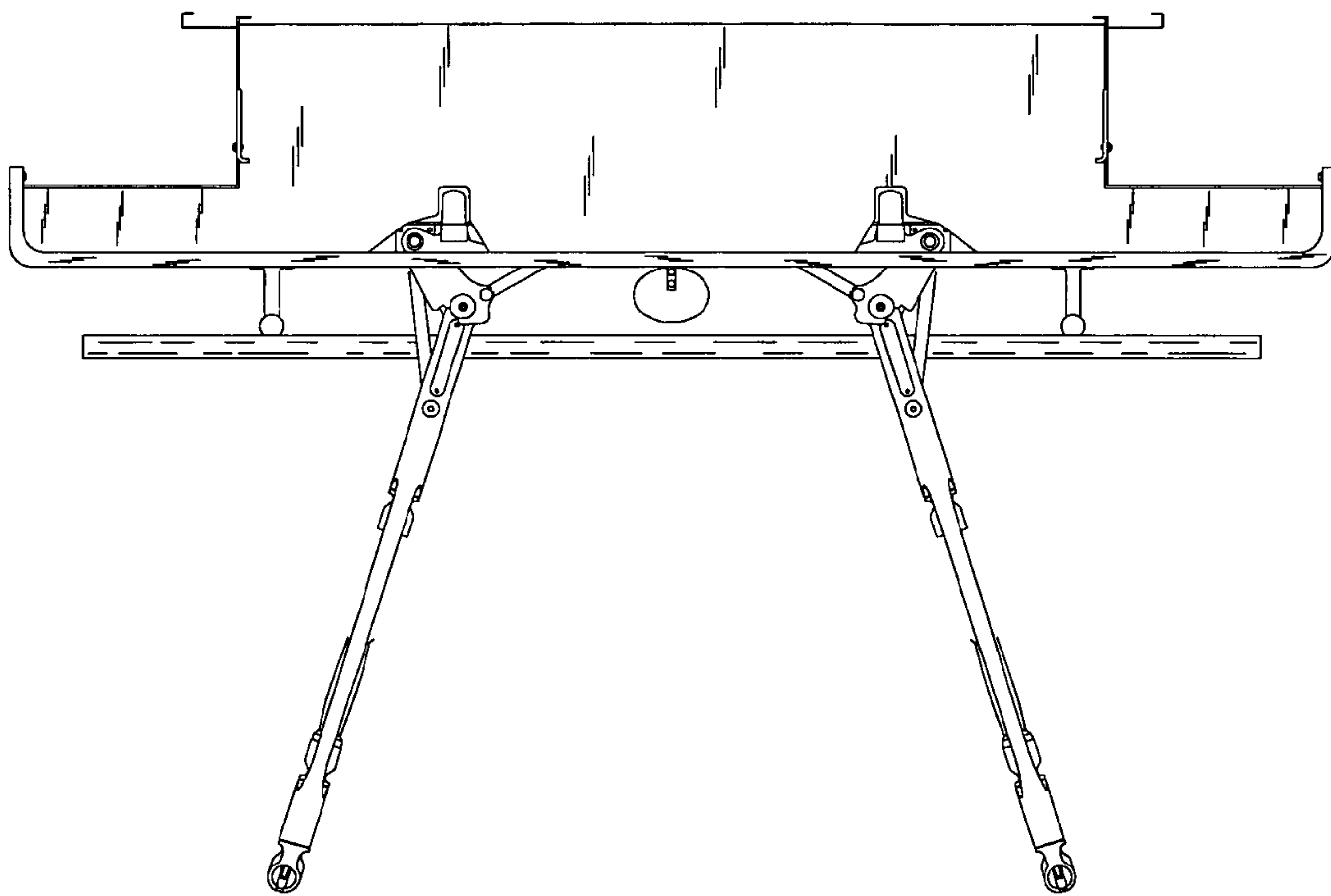

Fig. 4

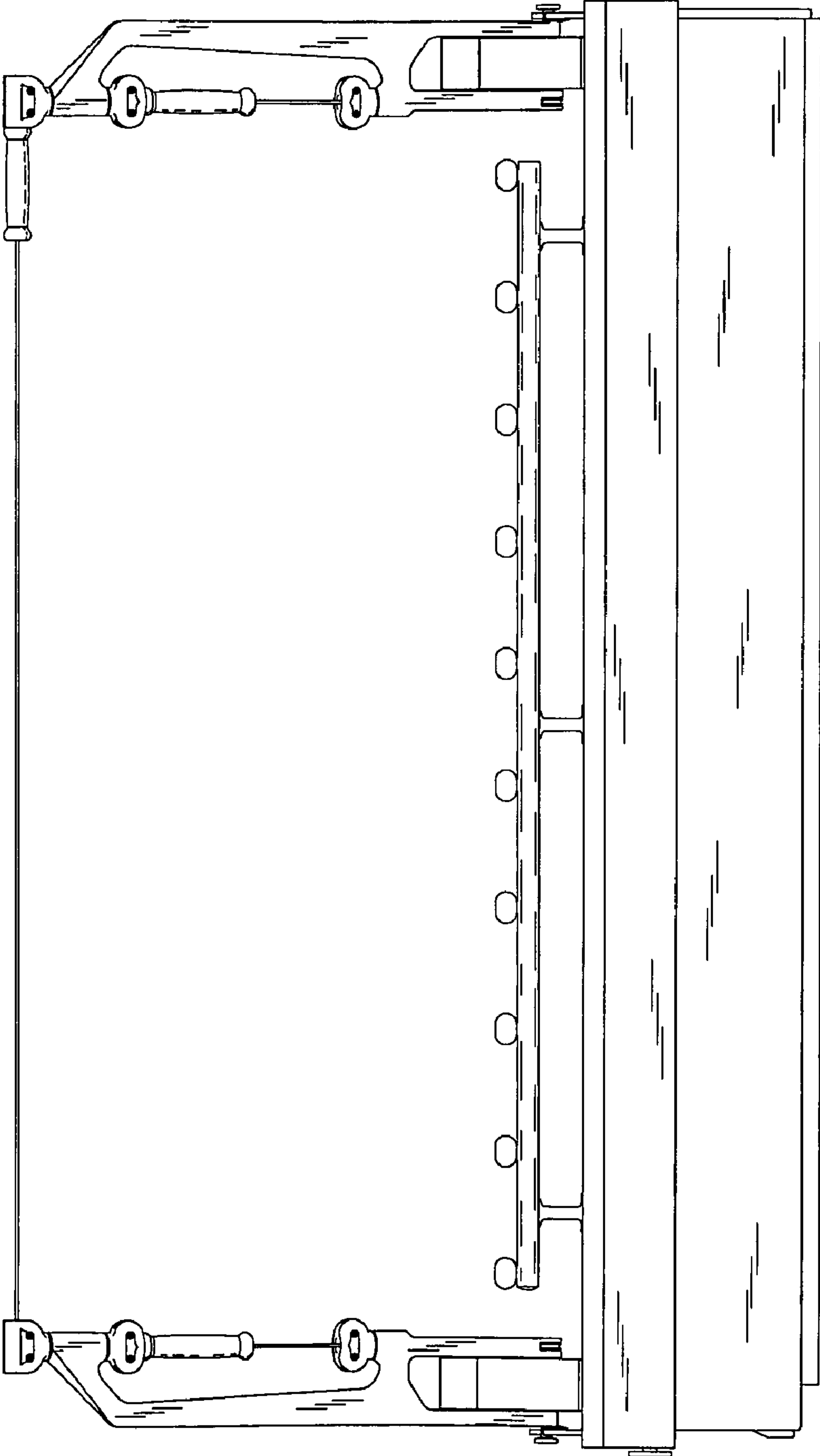

Fig. 5

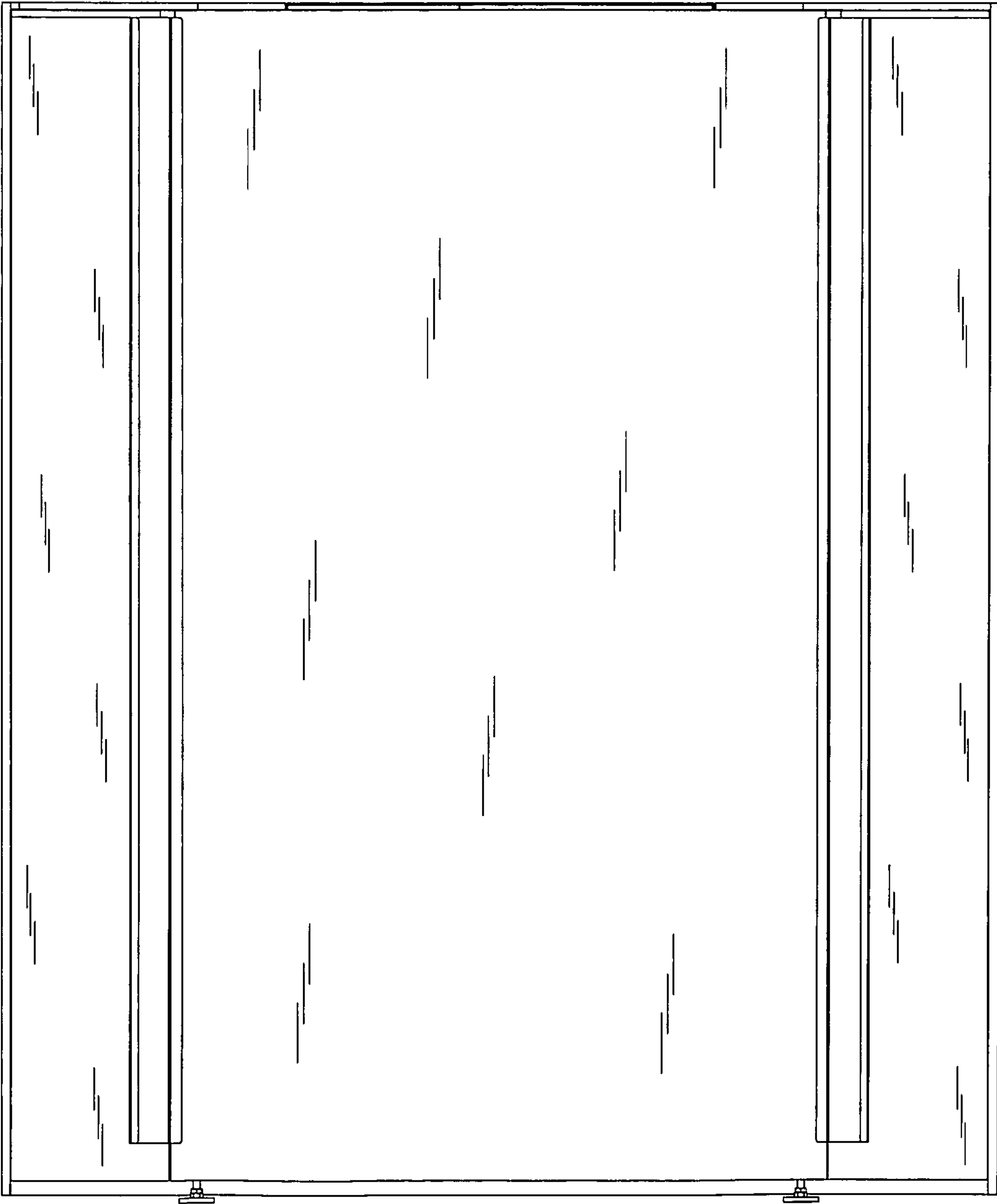

Fig. 6

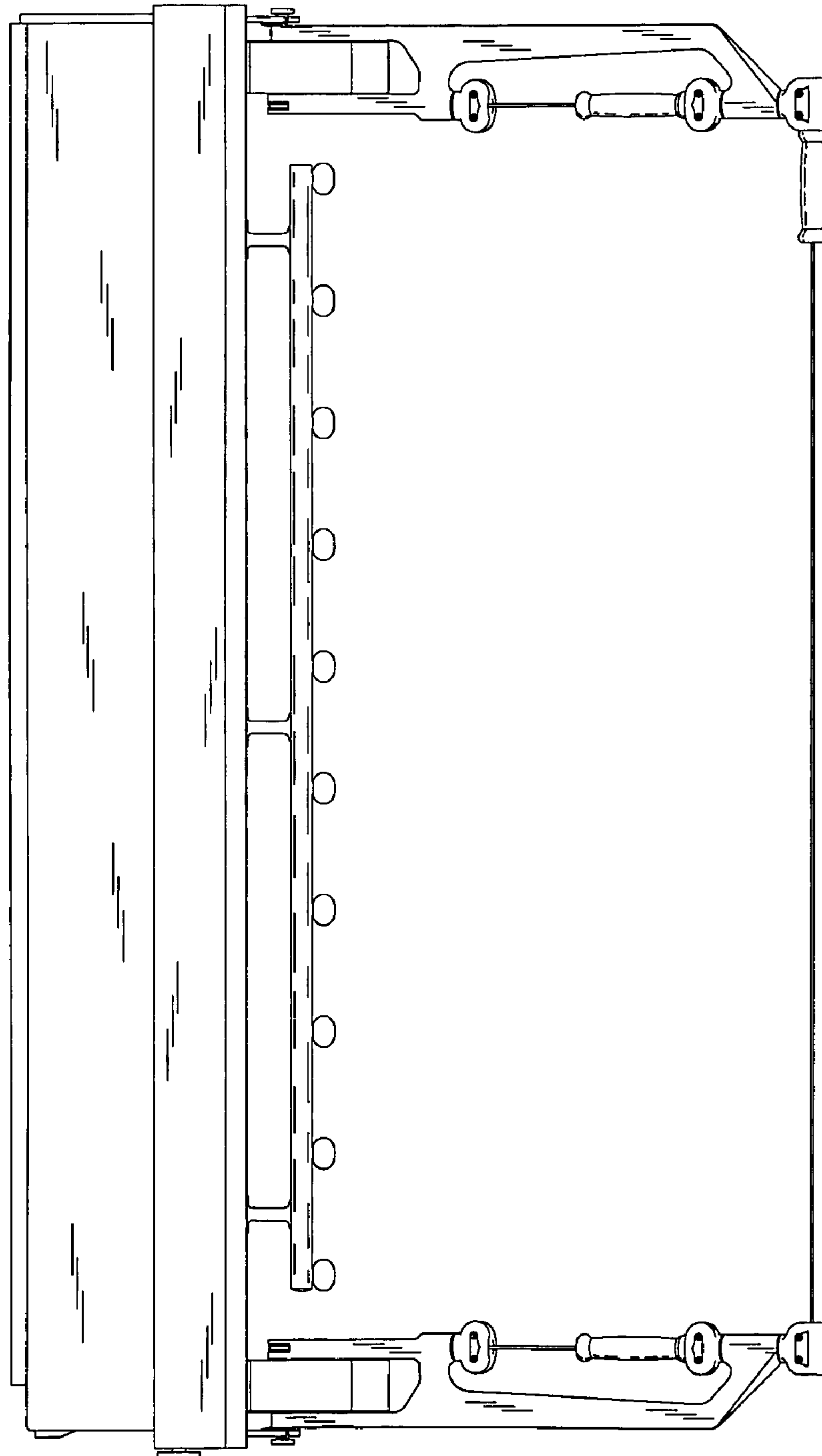



Fig. 7

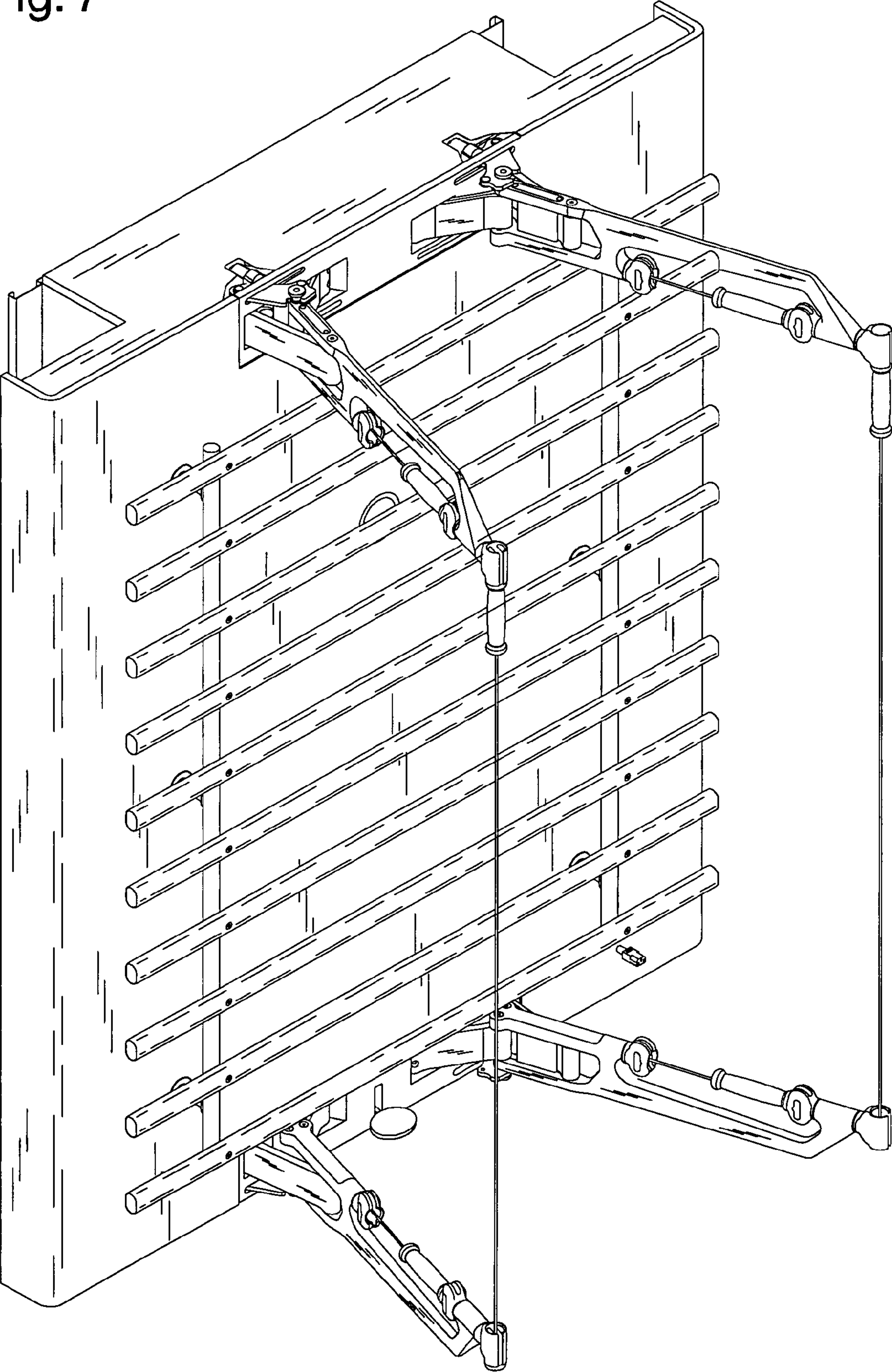



Fig. 8

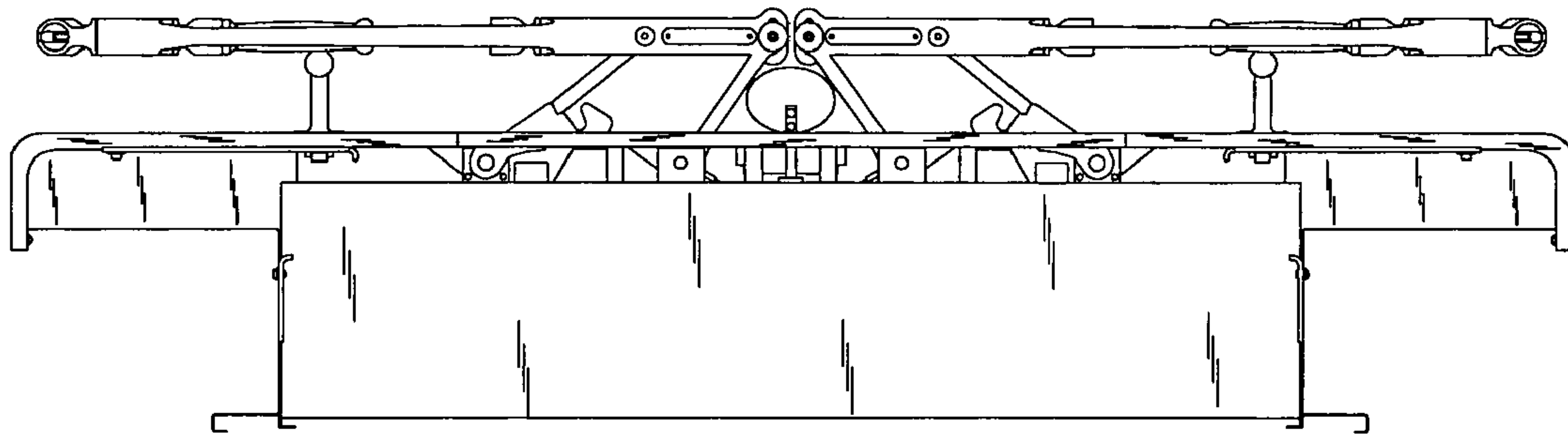

Fig. 9

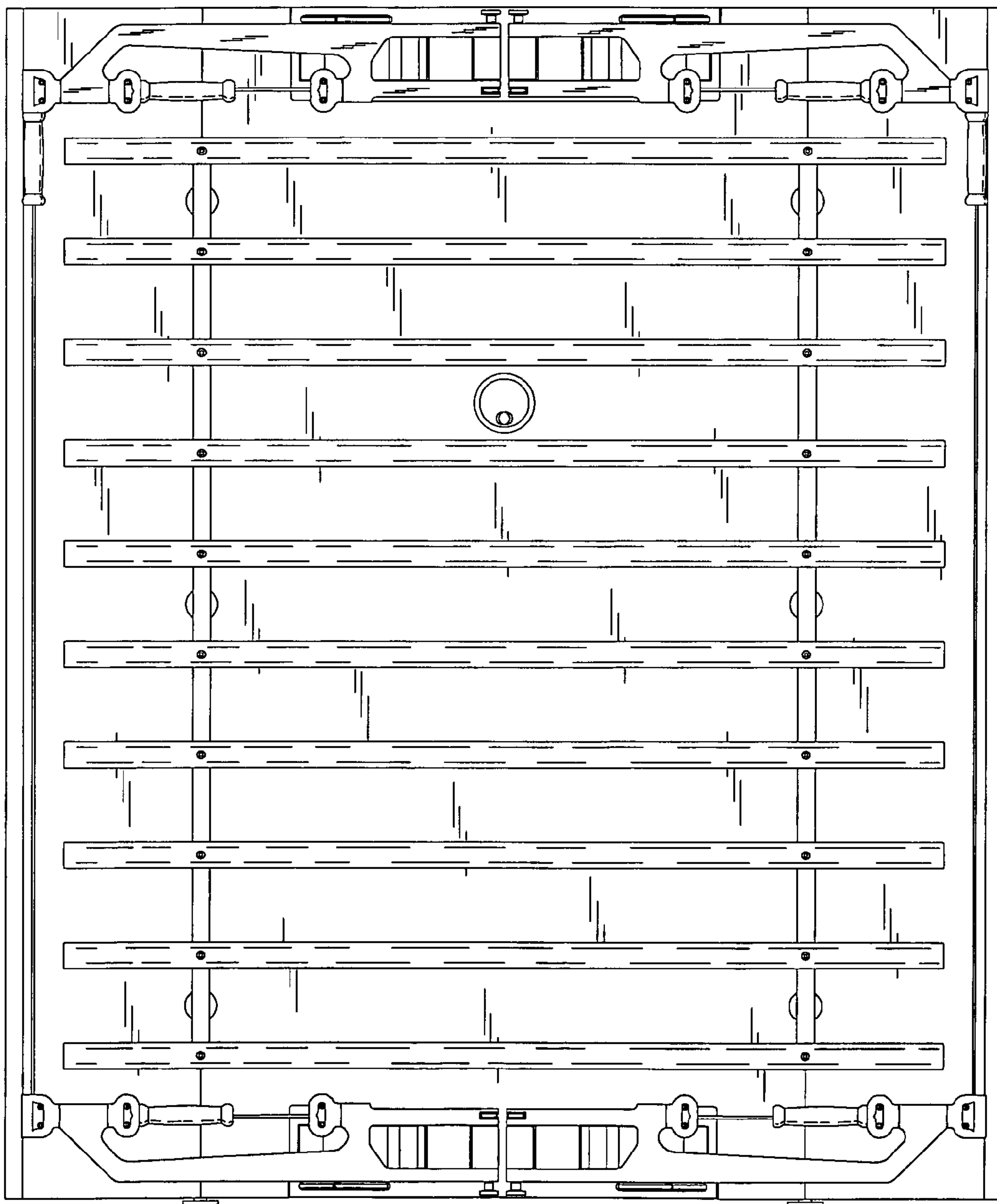

Fig. 10

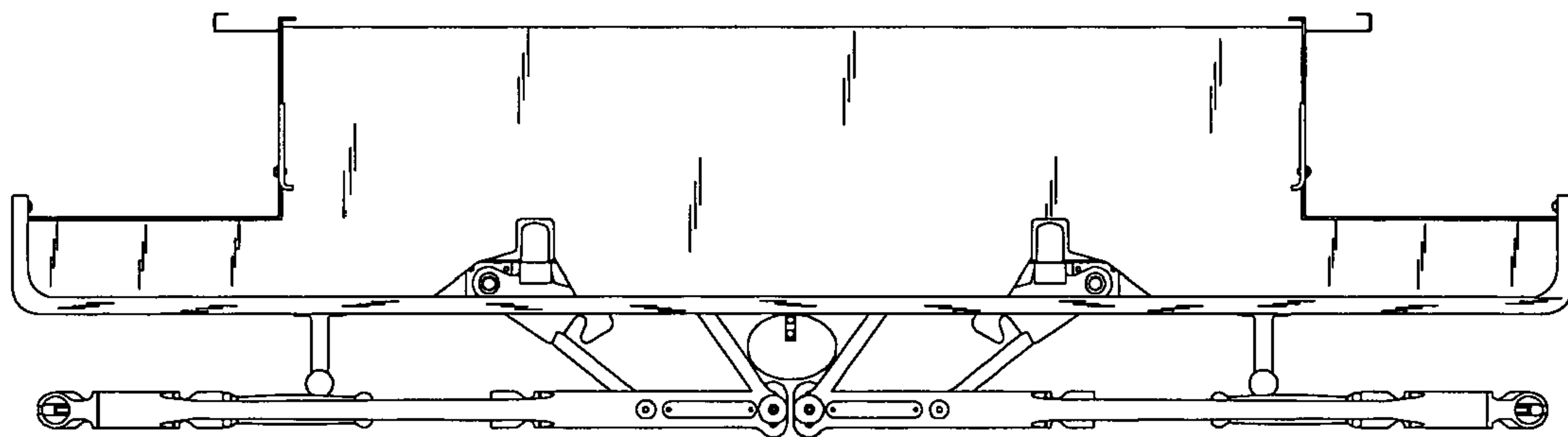

Fig. 11

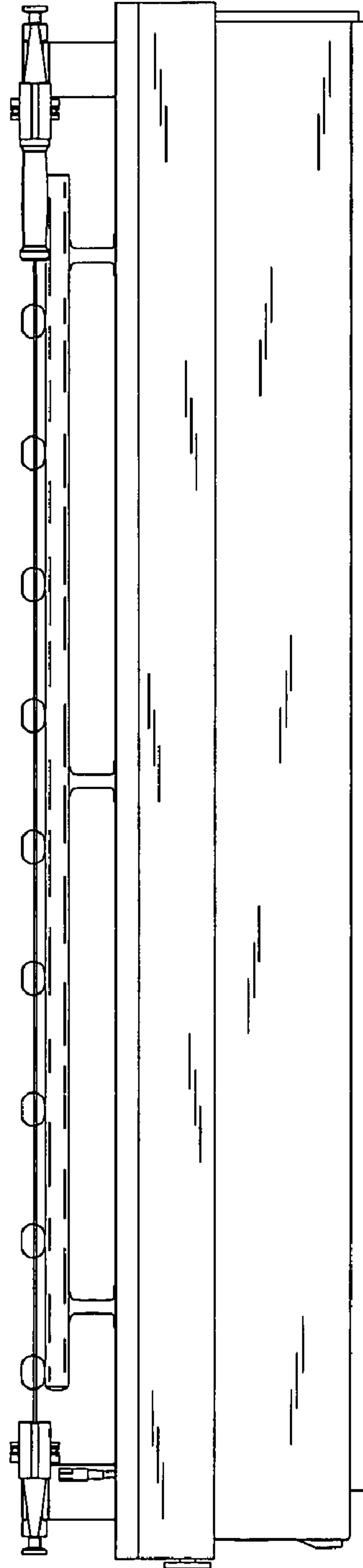

Fig. 12

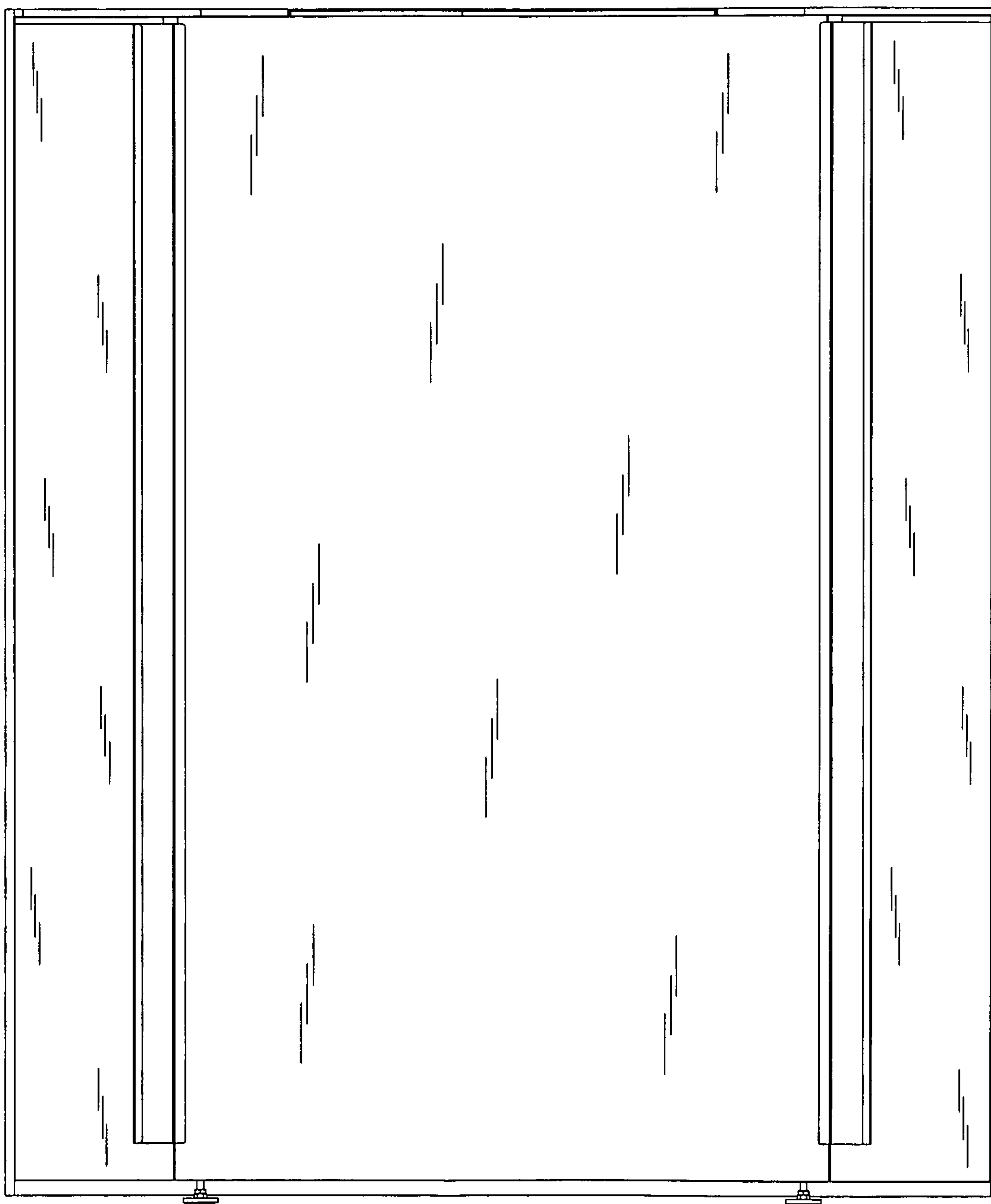

Fig. 13

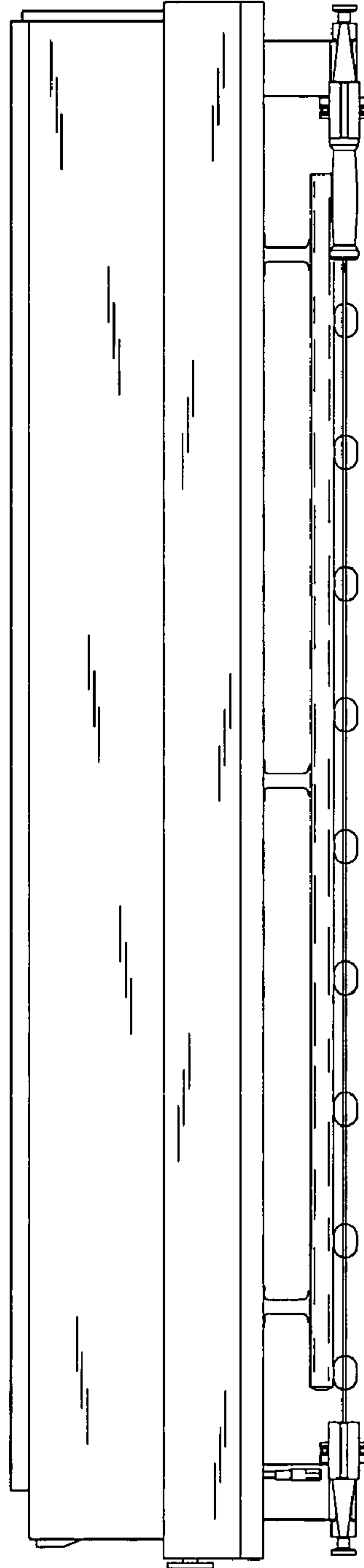



Fig. 14

