



US00D586272S

(12) **United States Design Patent**
Schulz

(10) **Patent No.:** **US D586,272 S**

(45) **Date of Patent:** **** Feb. 10, 2009**

(54) **CLUTCH ACTUATOR**

2008/0121489 A1* 5/2008 Chevalier 192/105 BB

(75) Inventor: **Marcus Schulz**, Neustadt (DE)

* cited by examiner

(73) Assignee: **WABCO GmbH**, Hannover (DE)

Primary Examiner—Sandra Snapp

Assistant Examiner—Patricia Palasik

(**) Term: **14 Years**

(74) *Attorney, Agent, or Firm*—Kramer Levin Naftalis & Frankel LLP

(21) Appl. No.: **29/301,598**

(22) Filed: **Mar. 6, 2008**

(57) **CLAIM**

The ornamental design for a clutch actuator, as shown and described.

(30) **Foreign Application Priority Data**

Sep. 10, 2007 (EM) 000786835

DESCRIPTION

(51) **LOC (9) Cl.** **12-16**

FIG. 1 is a perspective view of a clutch actuator showing the new design;

(52) **U.S. Cl.** **D12/180**

FIG. 2 is a top plan view thereof;

(58) **Field of Classification Search** D12/179,

FIG. 3 is a front elevational view thereof;

D12/180, 218; 188/18 A, 71.5, 170; 303/7,

FIG. 4 is a right side elevational view thereof;

303/10, 20, 87, 113.5, 114.1, 119.2, 119.3

FIG. 5 is a left side elevational view thereof;

See application file for complete search history.

FIG. 6 is a rear elevational view thereof; and,

(56) **References Cited**

U.S. PATENT DOCUMENTS

FIG. 7 is a bottom plan view thereof.

The portions of the design depicted in broken lines form no part of the claimed design.

D499,173 S * 11/2004 Plath D23/245

D512,946 S * 12/2005 Hatakoshi et al. D12/180

D546,252 S * 7/2007 Belisle D12/180

2006/0266607 A1* 11/2006 Monette et al. 192/15

2006/0272876 A1* 12/2006 Ekonen et al. 180/249

1 Claim, 7 Drawing Sheets

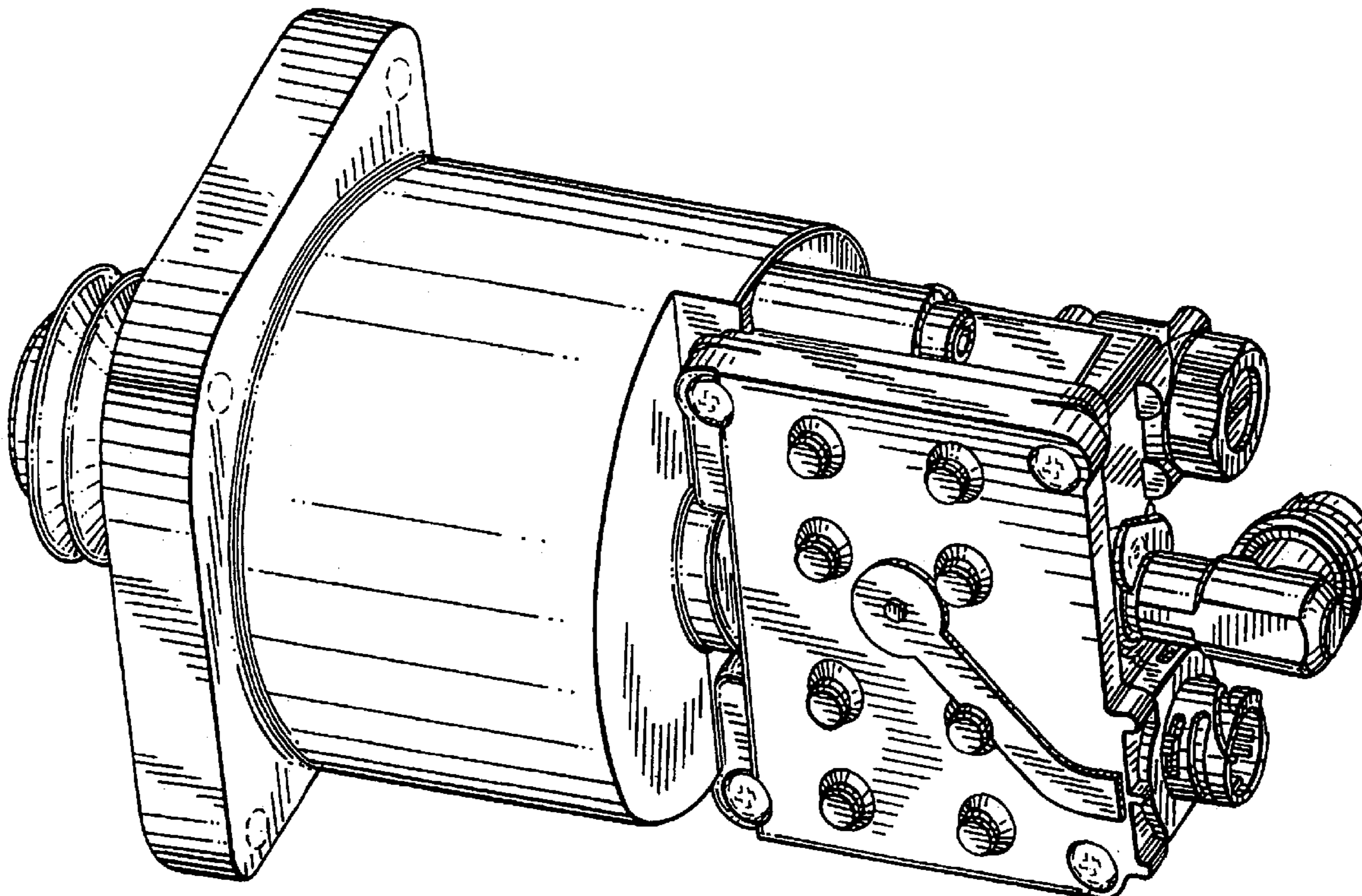

FIG. 1

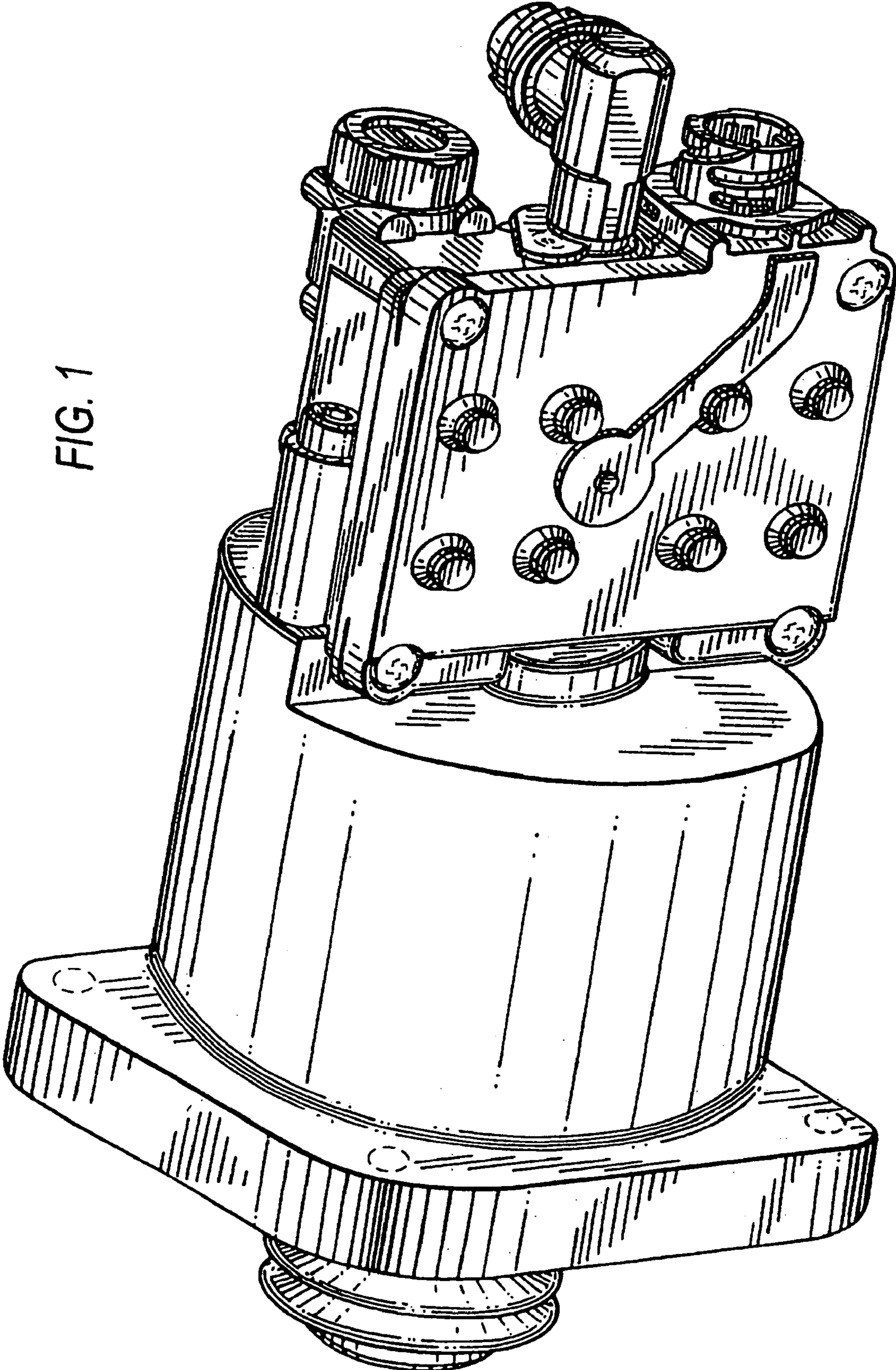

FIG. 2

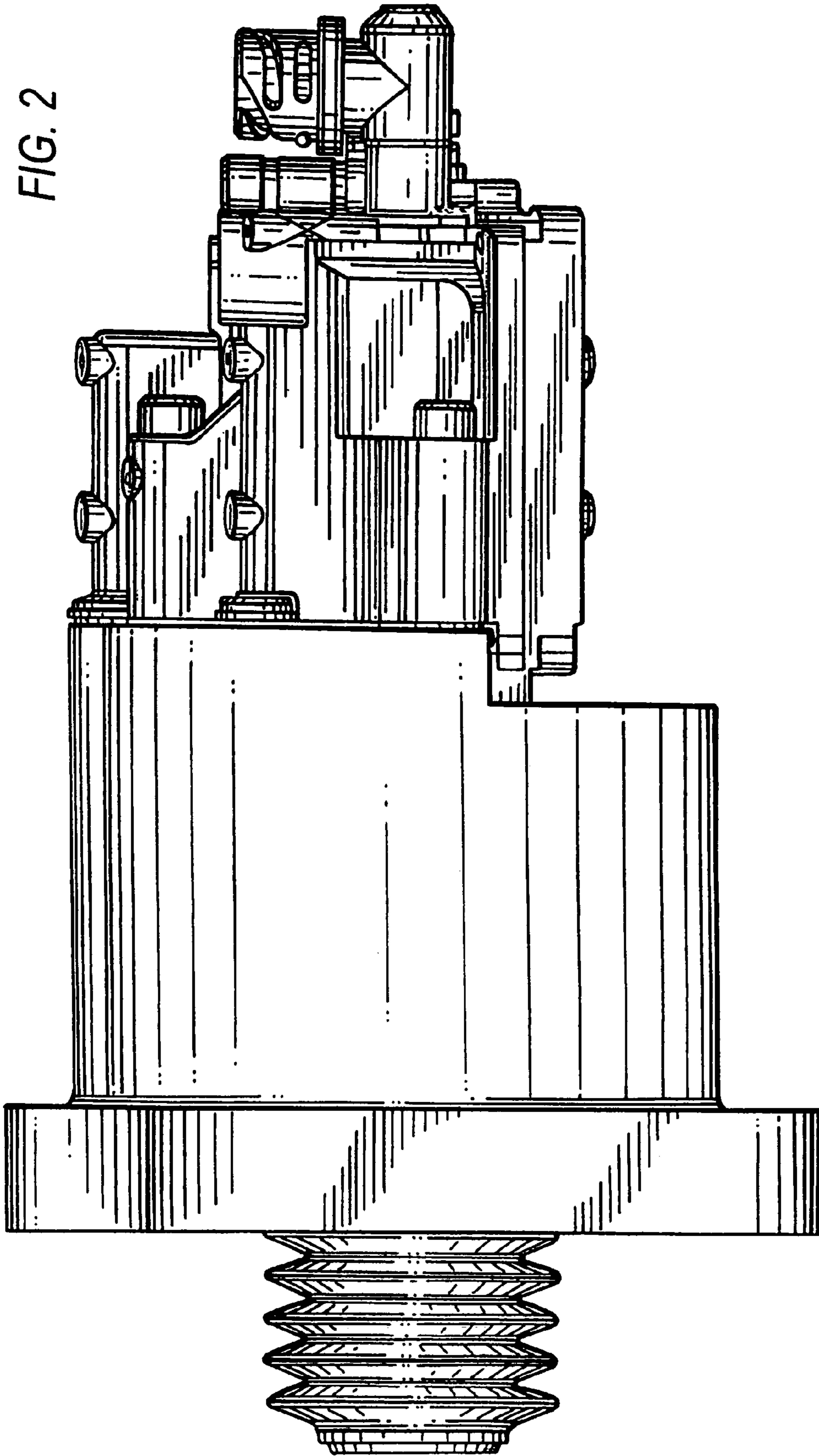
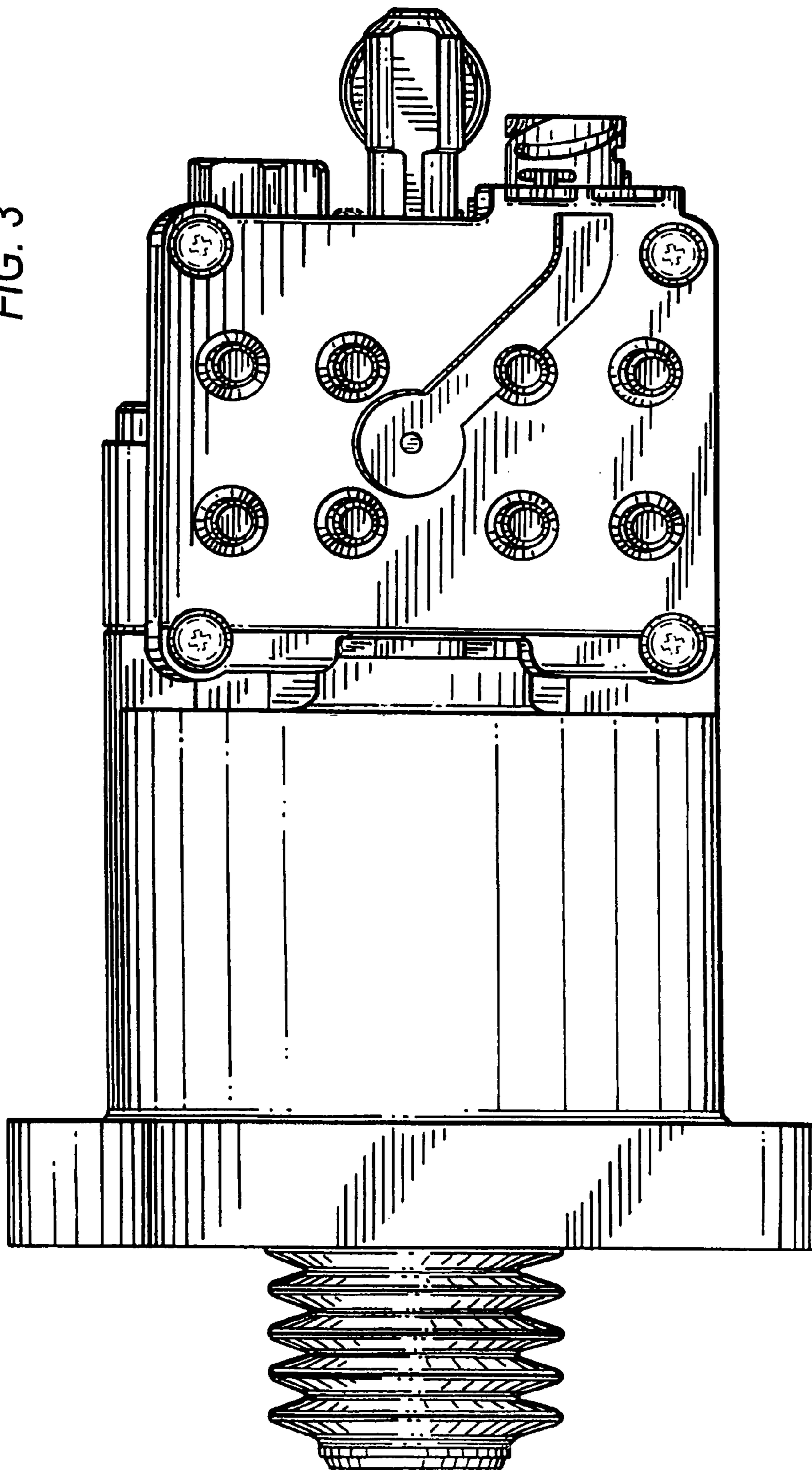

FIG. 3



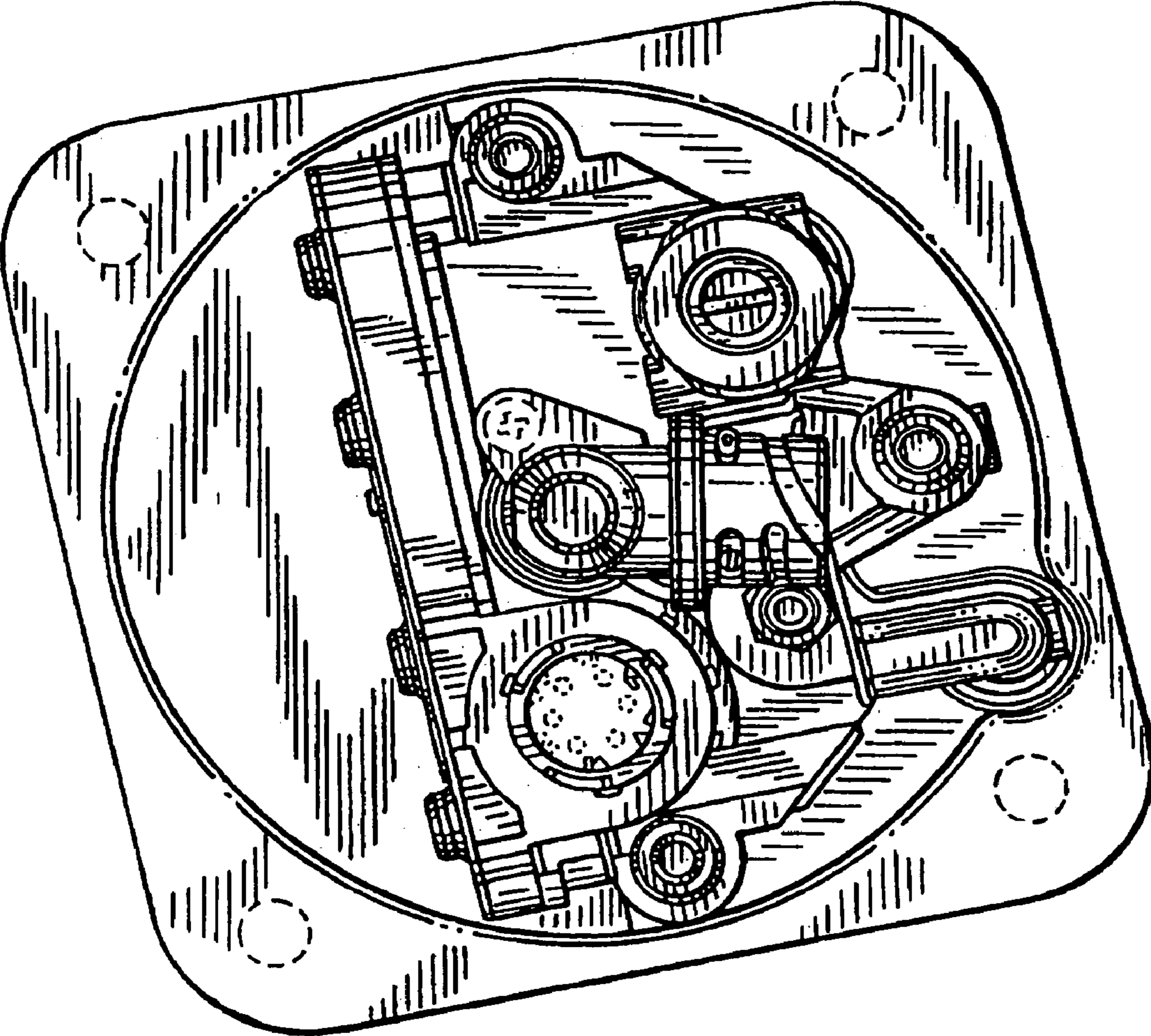

FIG. 4

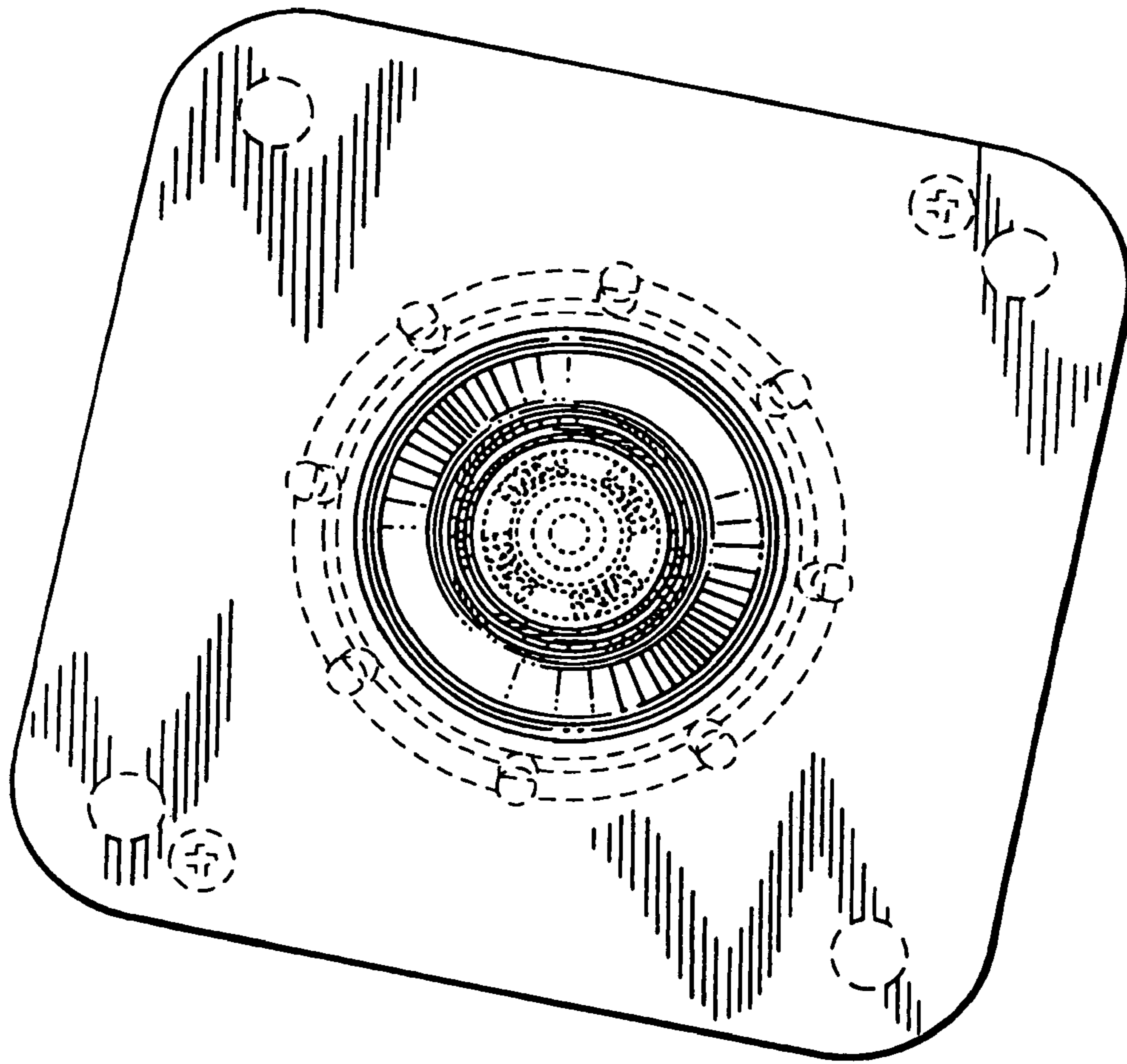

FIG. 5

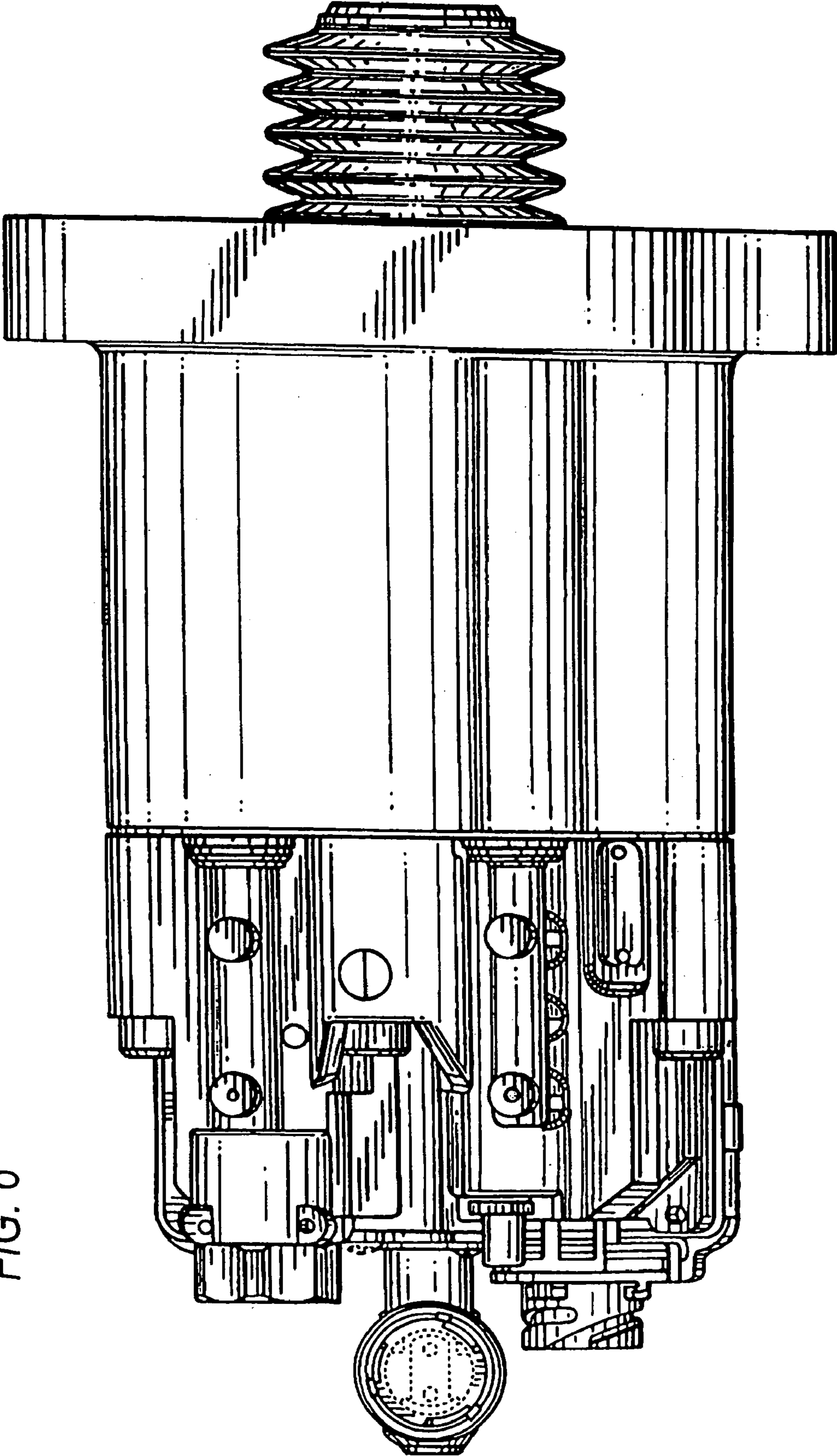

FIG. 6

FIG. 7

