



US00D586151S

(12) **United States Design Patent**
Roberts

(10) **Patent No.:** **US D586,151 S**

(45) **Date of Patent:** **** Feb. 10, 2009**

(54) **STORAGE UNIT WITH A TV LIFT MECHANISM**

(76) Inventor: **Gary B. Roberts**, 7560 Rollingbrook Trail, Solon, OH (US) 44139

(**) Term: **14 Years**

(21) Appl. No.: **29/278,406**

(22) Filed: **Mar. 28, 2007**

(51) **LOC (9) Cl.** **06-04**

(52) **U.S. Cl.** **D6/445; D6/432**

(58) **Field of Classification Search** D6/397,
D6/422-426, 429, 432-449, 460-461, 468,
D6/470, 474, 477-480, 484; D34/14, 17,
D34/19; 108/59, 65-66, 91-93, 106-107,
108/180, 144.1, 147.11; 211/34, 36, 42,
211/134; 312/194, 198, 204

See application file for complete search history.

(56) **References Cited**

U.S. PATENT DOCUMENTS

D446,053 S *	8/2001	Wohlford	D6/479
D464,500 S *	10/2002	Roberts	D6/422
D470,333 S *	2/2003	Roberts	D6/422
D477,474 S *	7/2003	Milligan	D6/446
D522,770 S *	6/2006	Easton	D6/436
D560,399 S *	1/2008	Roberts	D6/477
D566,429 S *	4/2008	Roberts	D6/477

* cited by examiner

Primary Examiner—Caron Veynar

Assistant Examiner—Ricky Pham

(74) *Attorney, Agent, or Firm*—Calfee, Halter & Griswold LLP

(57) **CLAIM**

The ornamental design for a storage unit with a TV lift mechanism, as shown and described.

DESCRIPTION

This case is related to U.S. Pat. Ser. Nos. D470,333 and D464,500 and co-pending U.S. Pat. Application Ser. No. 29/265,486.

FIG. 1 is a front/left/top isometric view of a storage unit with a TV lift mechanism showing my new design;

FIG. 2 is a left side elevational view thereof; the right side elevational view being a mirror image thereof;

FIG. 3 is a front elevational view thereof;

FIG. 4 is a rear elevational view thereof;

FIG. 5 is a top plan view thereof;

FIG. 6 is a bottom plan view thereof; and,

FIG. 7 is a front/left/top isometric view thereof; shown with the top lift portion in an open configuration for ease of illustration.

The broken lines in the figures represent environment and form no part of the claimed design.

1 Claim, 4 Drawing Sheets

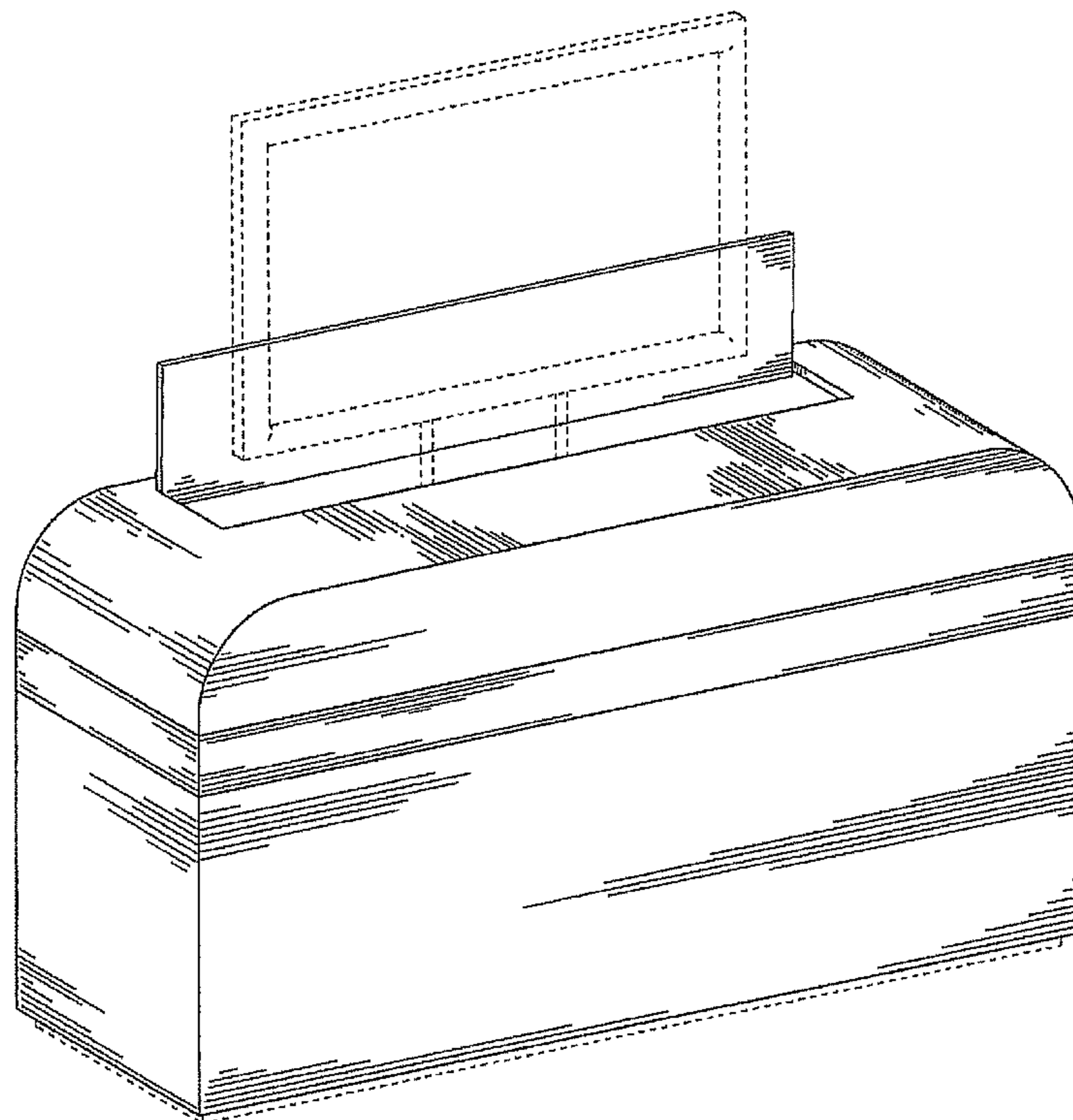

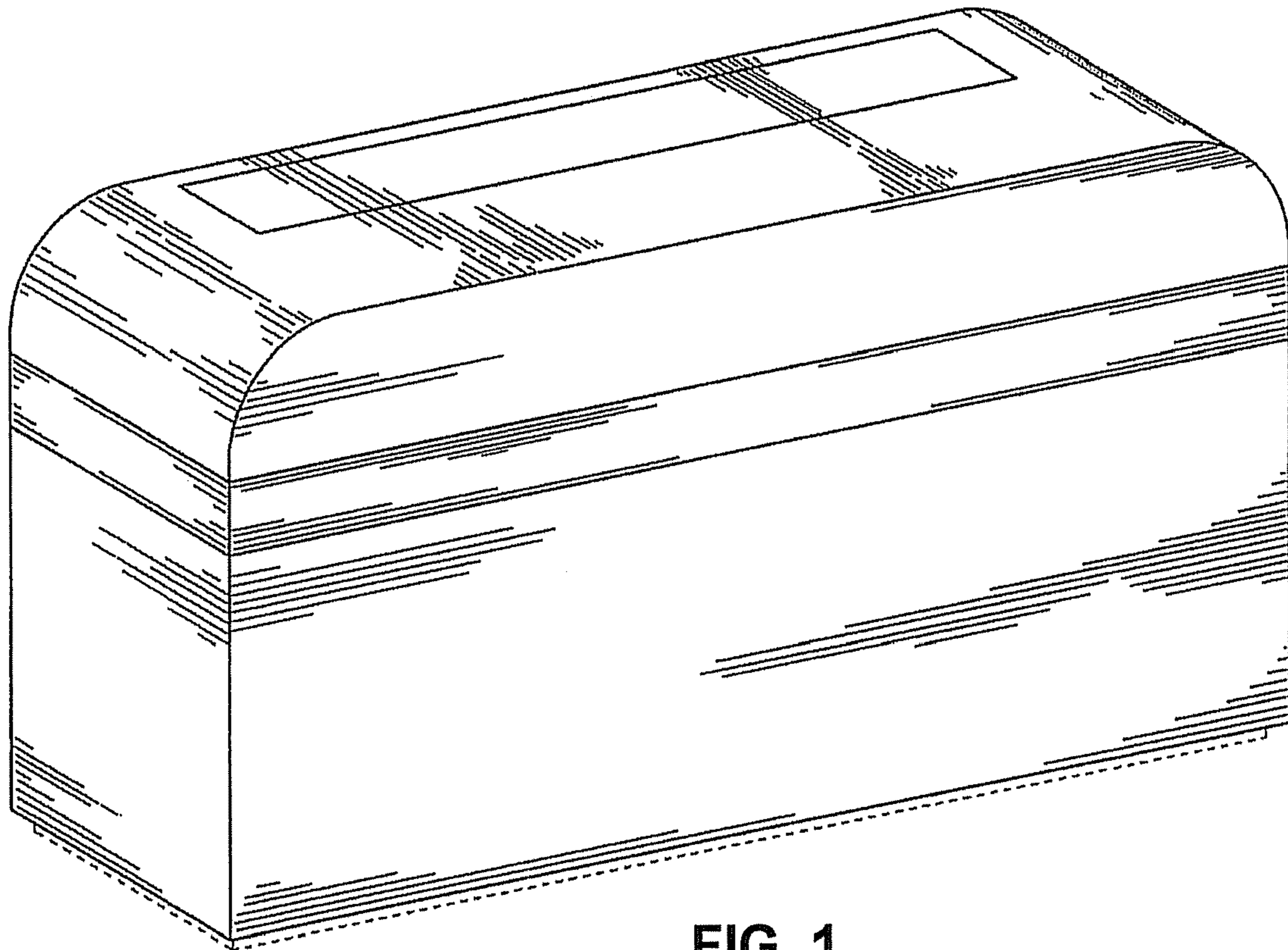

FIG. 1

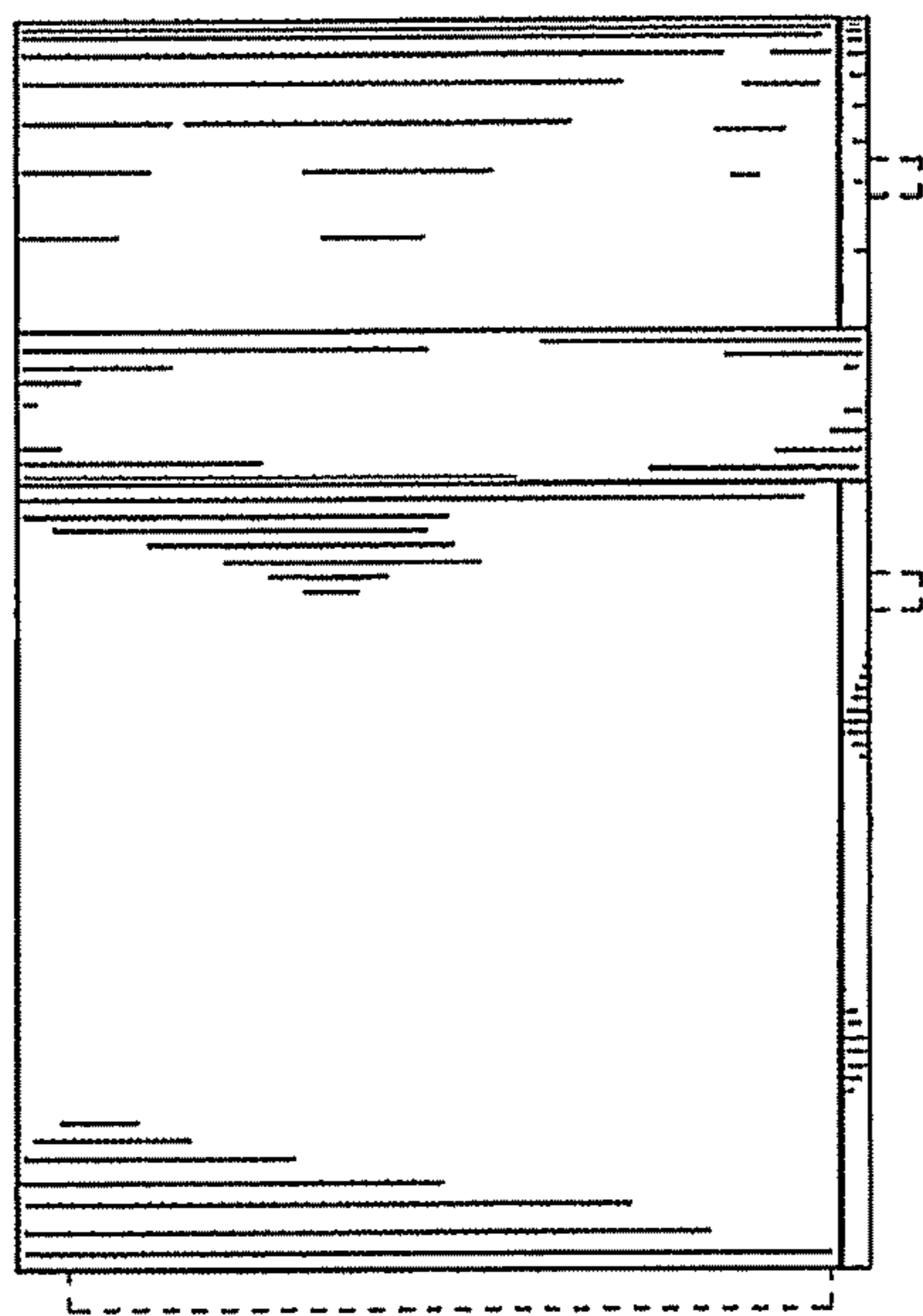

FIG. 2

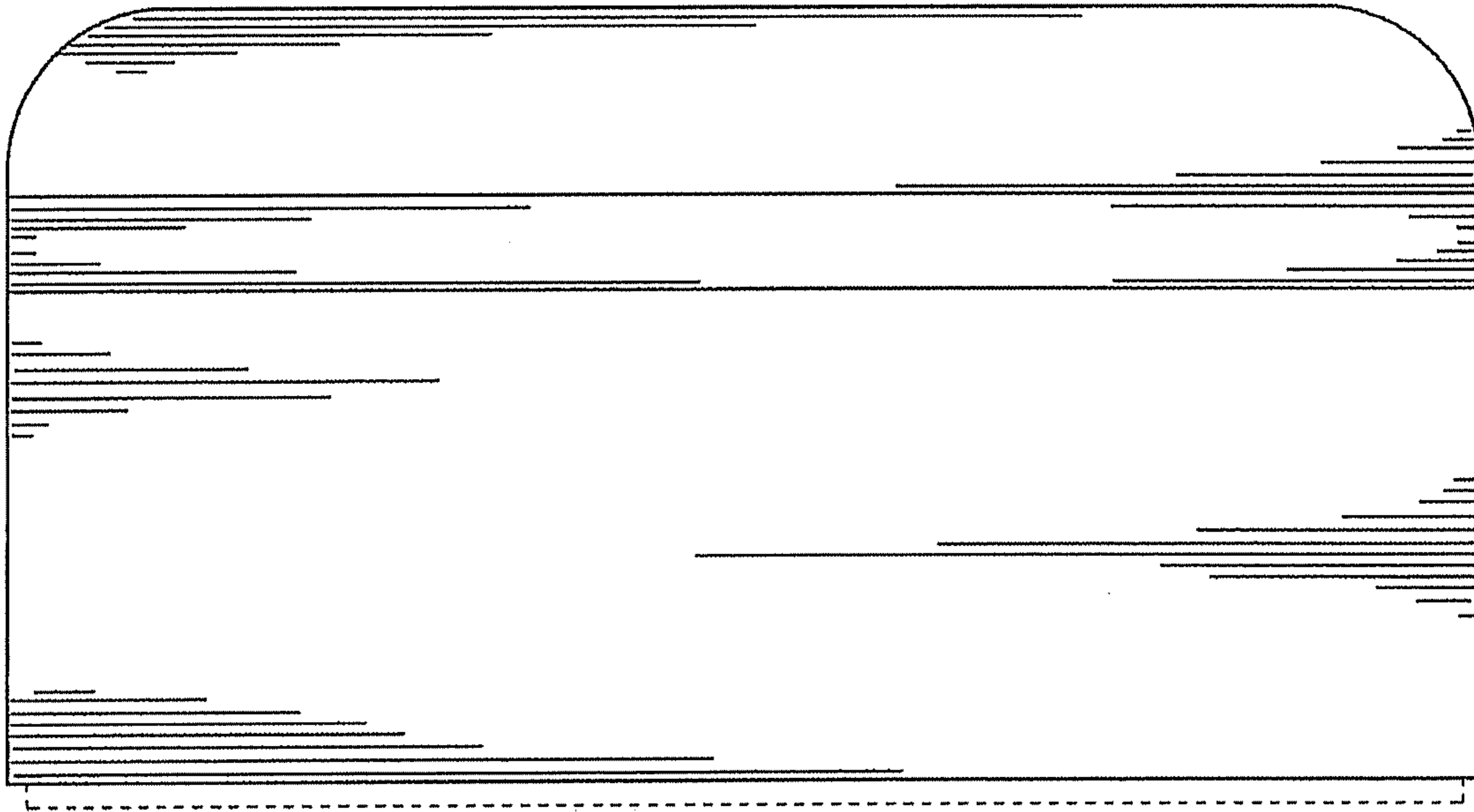

FIG. 3

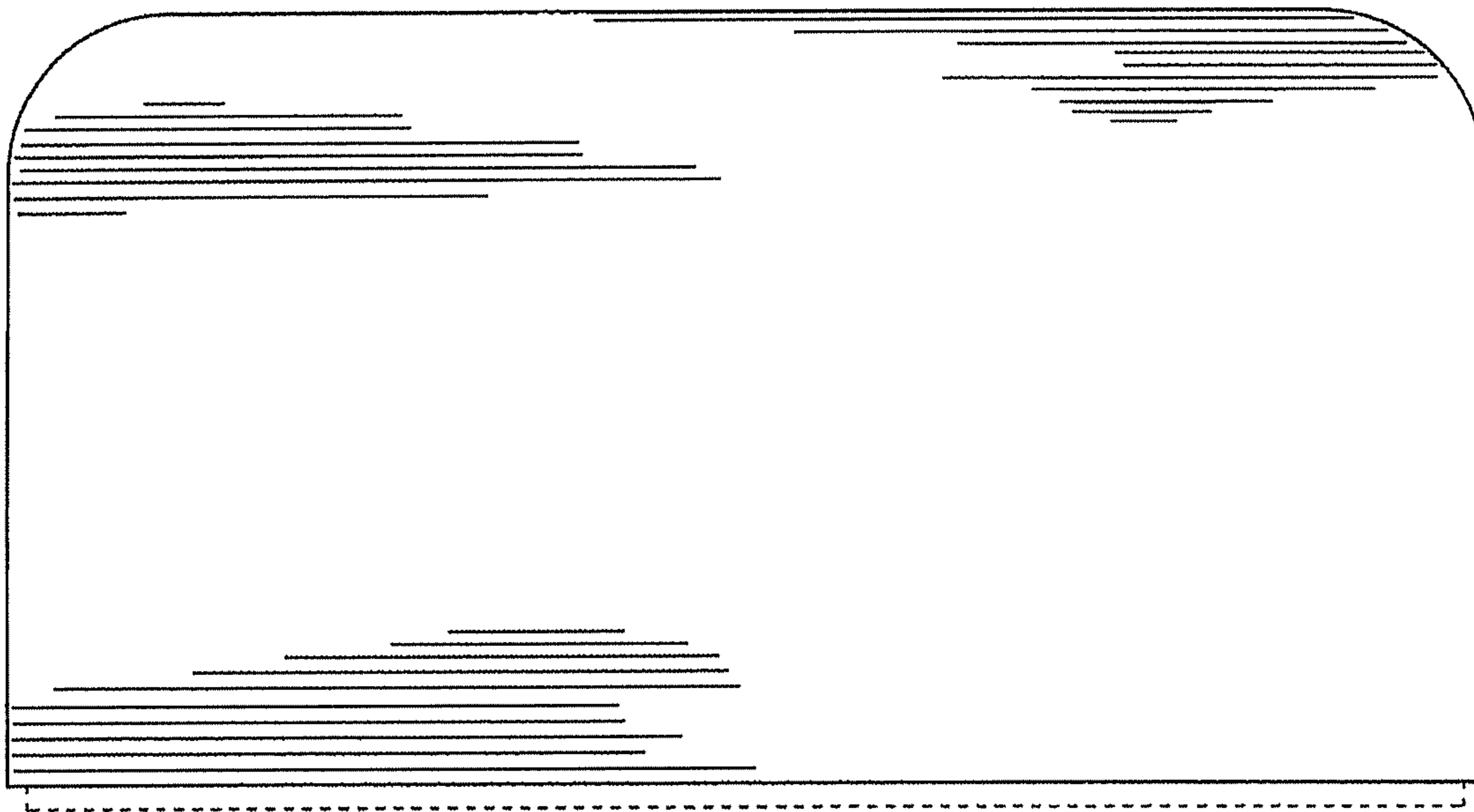

FIG. 4

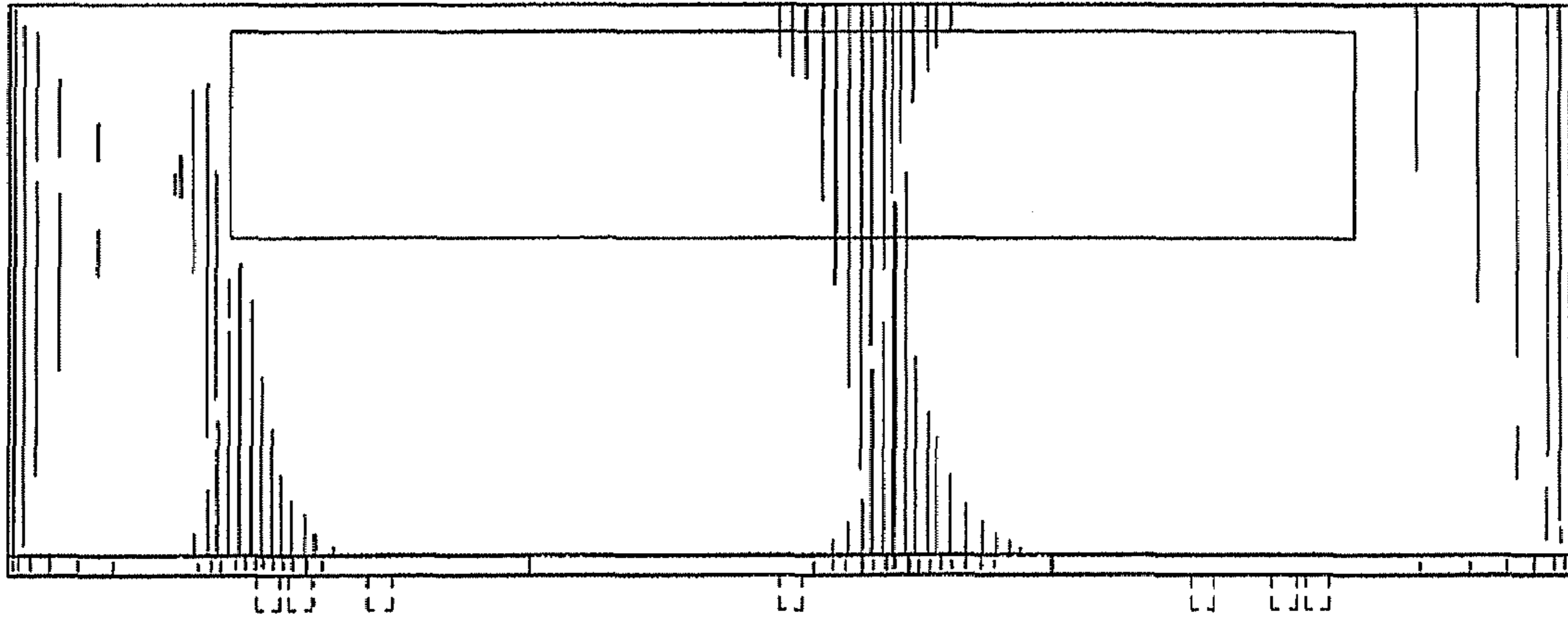

FIG. 5

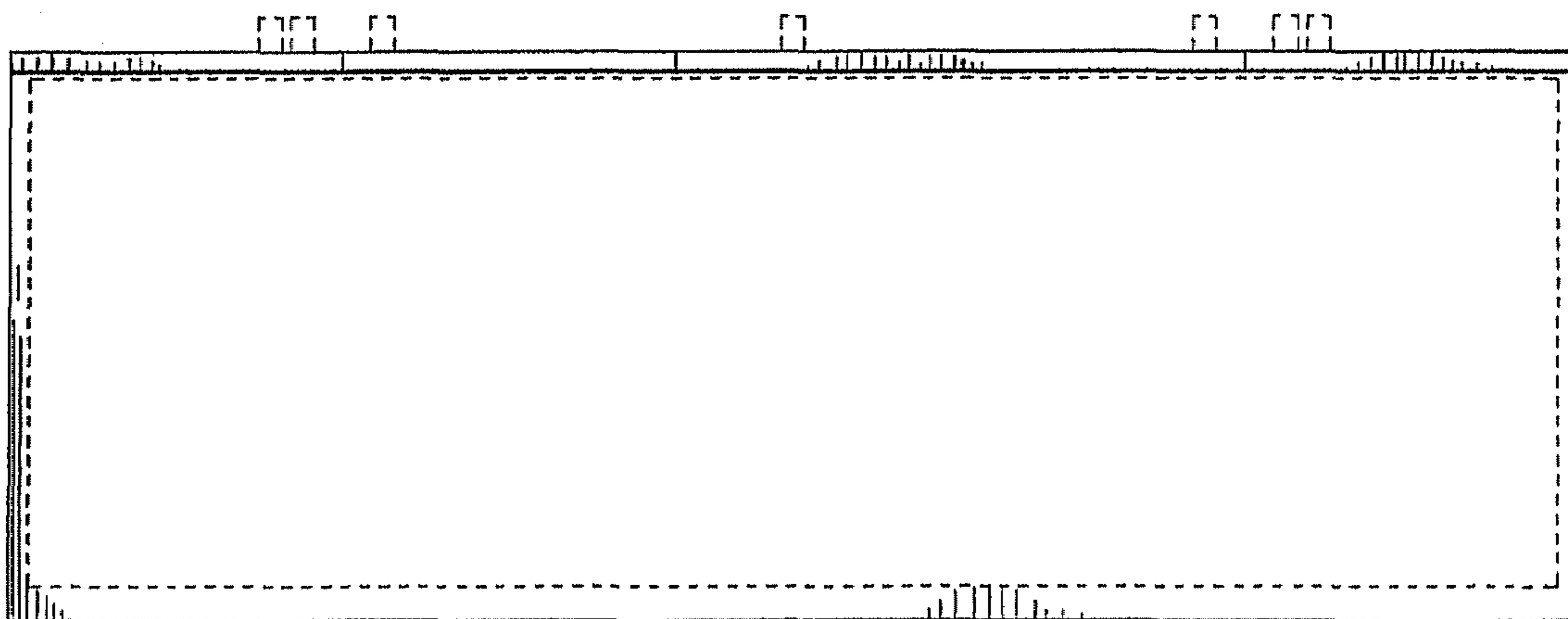

FIG. 6

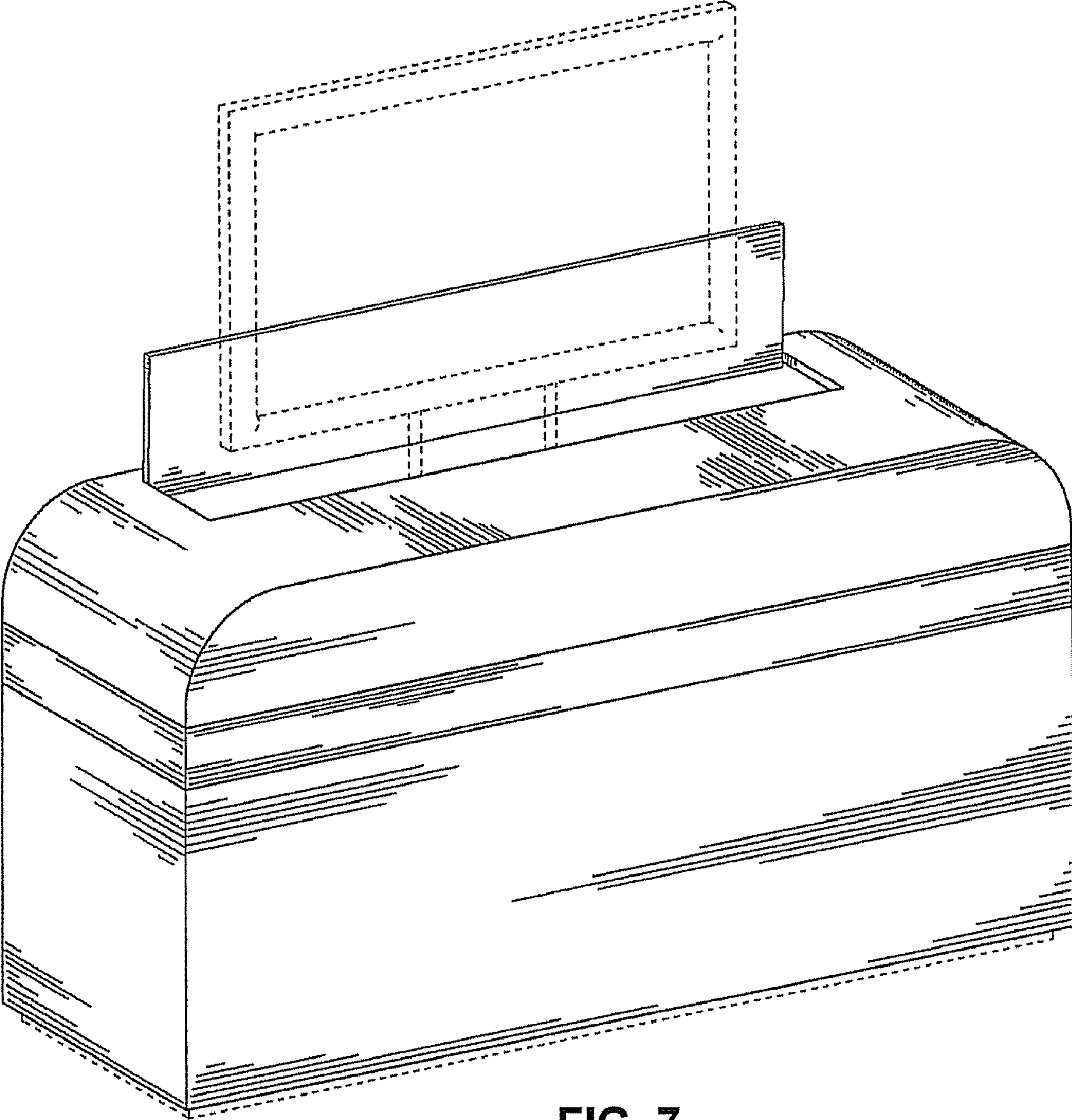

FIG. 7