



US00D586030S

(12) **United States Design Patent**
Genova

(10) **Patent No.:** **US D586,030 S**

(45) **Date of Patent:** **** Feb. 3, 2009**

(54) **SPA LIGHT WITH SOLAR POWER PANEL**

(76) **Inventor:** **Michael C. Genova**, 5342 N. Florida St.,
Spokane, WA (US) 99217

(**) **Term:** **14 Years**

(21) **Appl. No.:** **29/301,379**

(22) **Filed:** **Feb. 26, 2008**

(51) **LOC (9) Cl.** **26-03**

(52) **U.S. Cl.** **D26/85**

(58) **Field of Classification Search** D26/72,
D26/85-92, 24; D10/114; 362/147, 431,
362/432, 362, 155-157, 183, 101

See application file for complete search history.

(56) **References Cited**

U.S. PATENT DOCUMENTS

D222,117 S *	9/1971	Batz	D26/85
D253,495 S *	11/1979	Bodine	D26/36
D315,416 S *	3/1991	Ziaylek et al.	D26/28
D337,846 S *	7/1993	Fiorato	D26/85
D378,621 S *	3/1997	Landefeld	D26/85
D380,853 S *	7/1997	Johnson	D26/85
D389,592 S *	1/1998	Reiser	D26/36
D487,529 S *	3/2004	Kowitz	D26/85

D530,037 S *	10/2006	Bucher et al.	D26/67
D563,588 S *	3/2008	Mullen	D26/85
D565,233 S *	3/2008	Ladewig et al.	D26/85

* cited by examiner

Primary Examiner—Clare E Heflin

(74) *Attorney, Agent, or Firm*—Gregory IPL, P.C.; Randy A. Gregory

(57) **CLAIM**

The ornamental design for a spa light with solar power panel, as shown and described.

DESCRIPTION

FIG. 1 is perspective view of a spa down light with solar power panel showing my new design;

FIG. 2 is a front view thereof;

FIG. 3 is a side view thereof;

FIG. 4 is a rear view thereof;

FIG. 5 is a top view thereof; and,

FIG. 6 is a bottom view thereof.

The broken lines are shown on the drawings for illustrative purposes only and form no part of the claimed design.

1 Claim, 3 Drawing Sheets

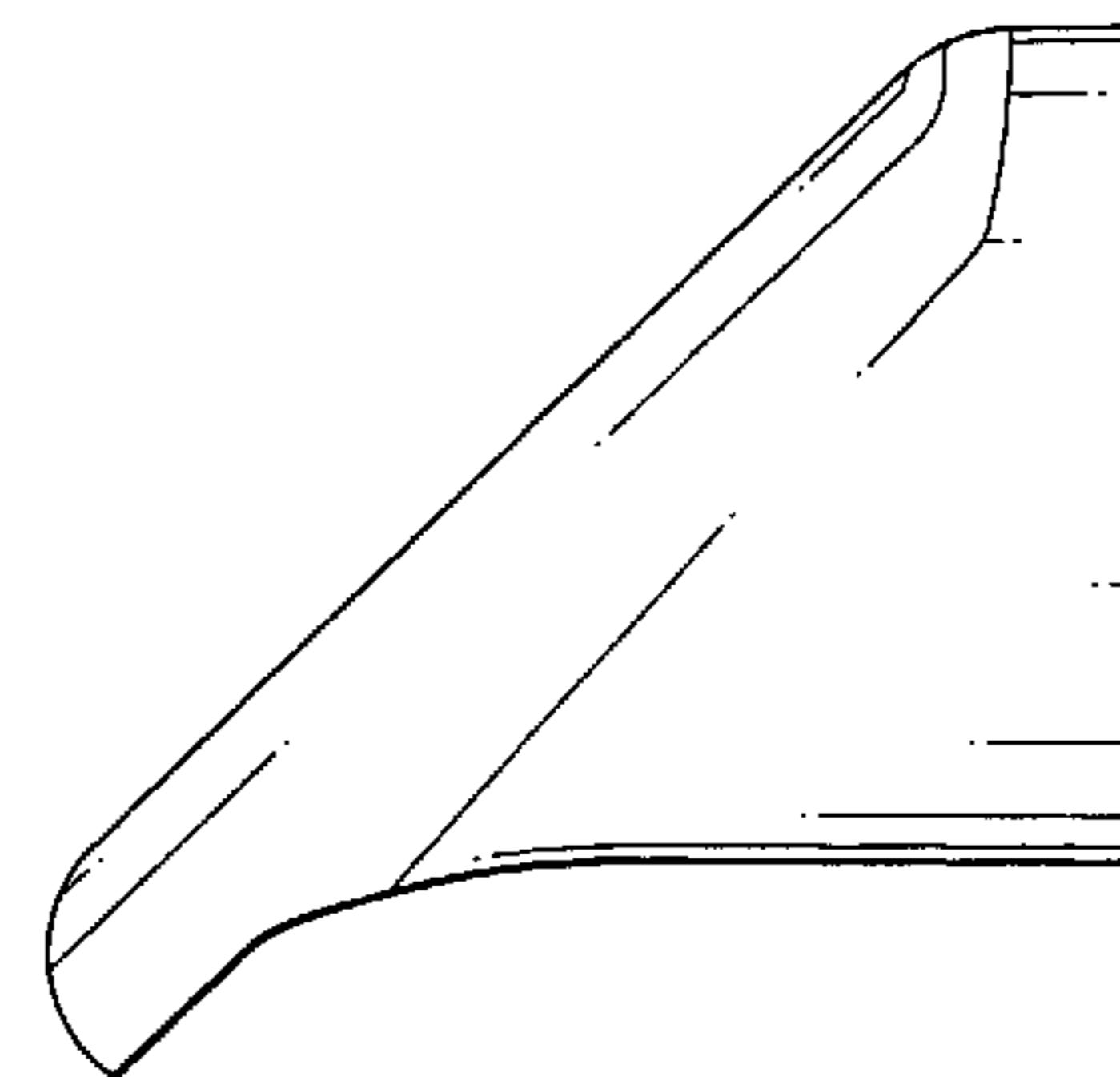
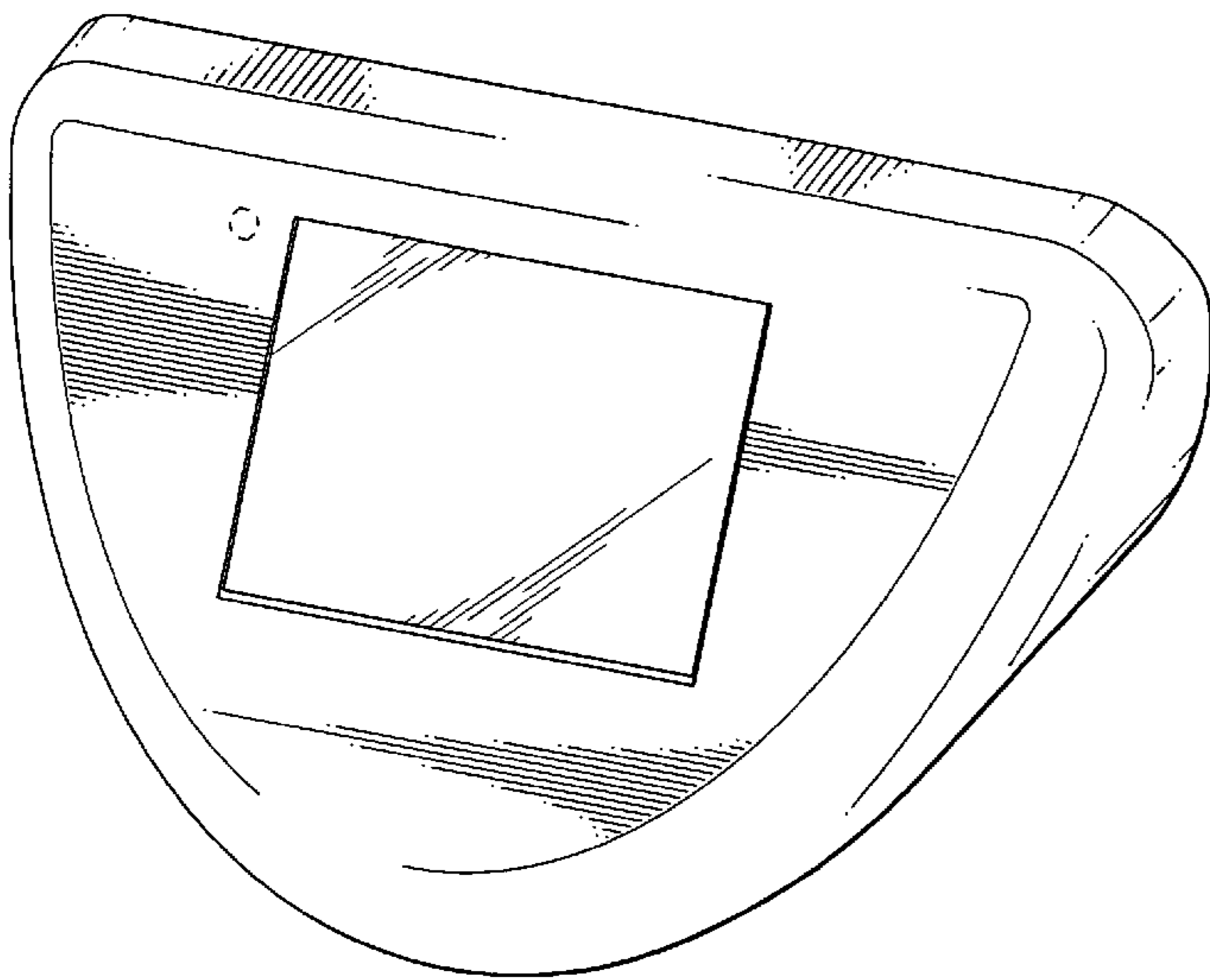

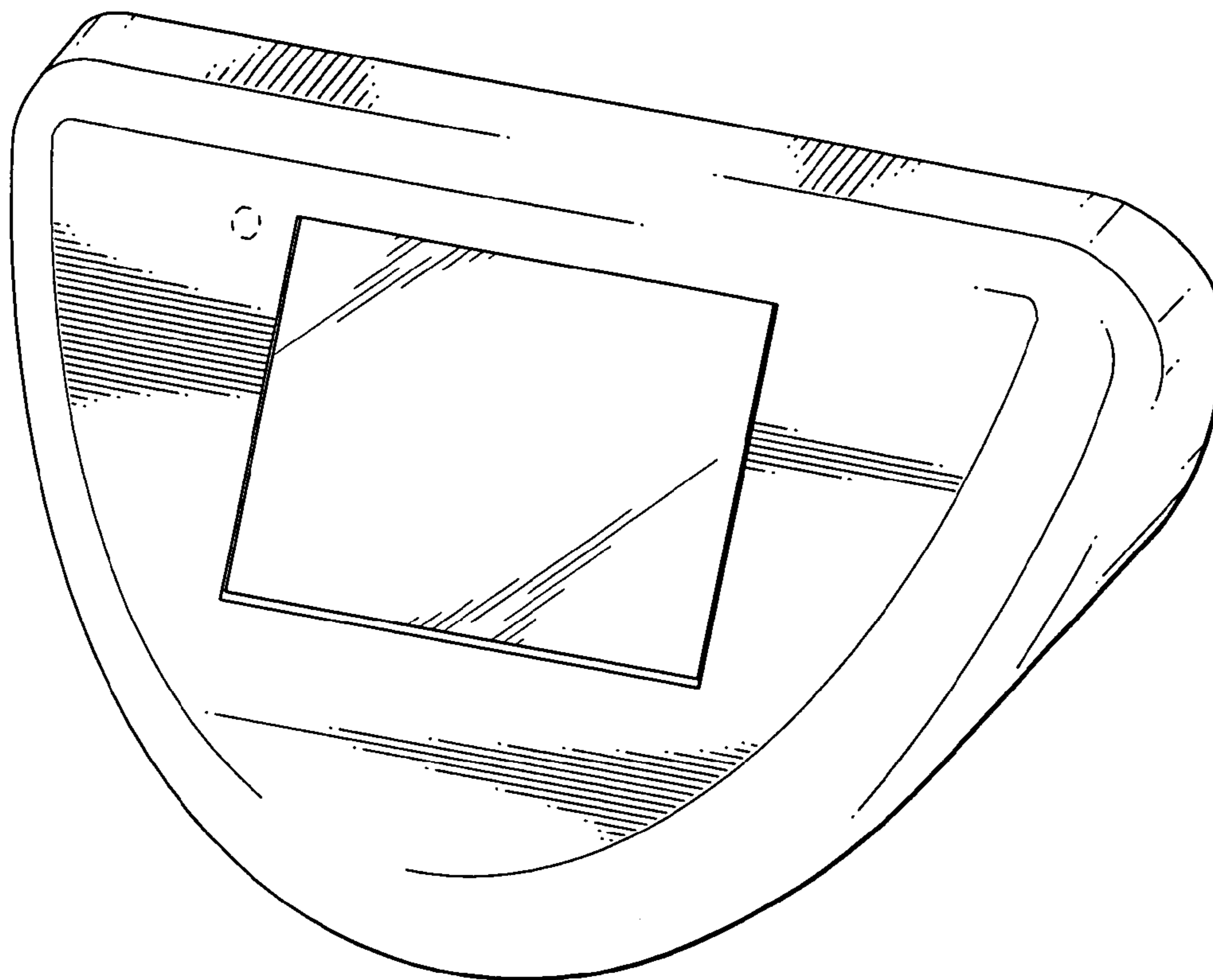

FIG. 1

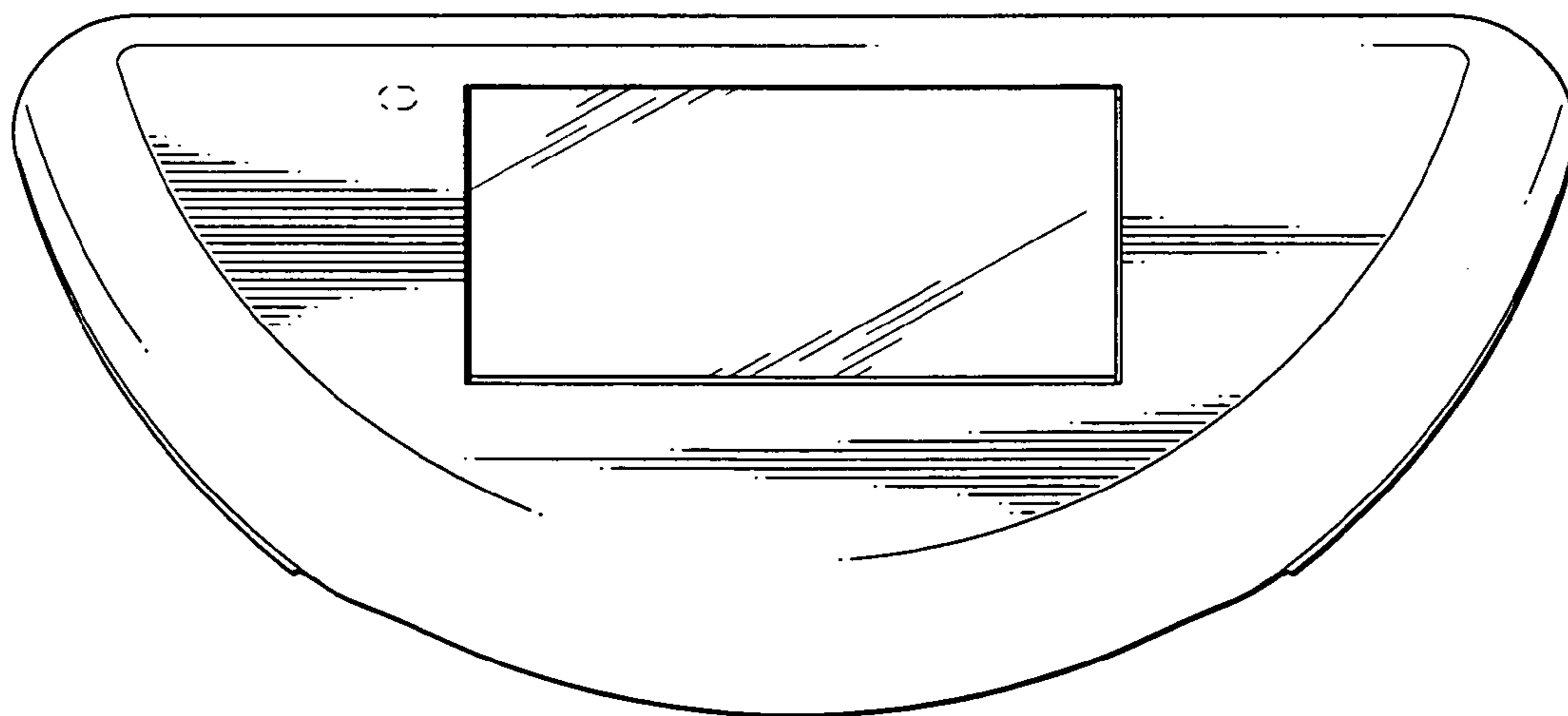

FIG. 2

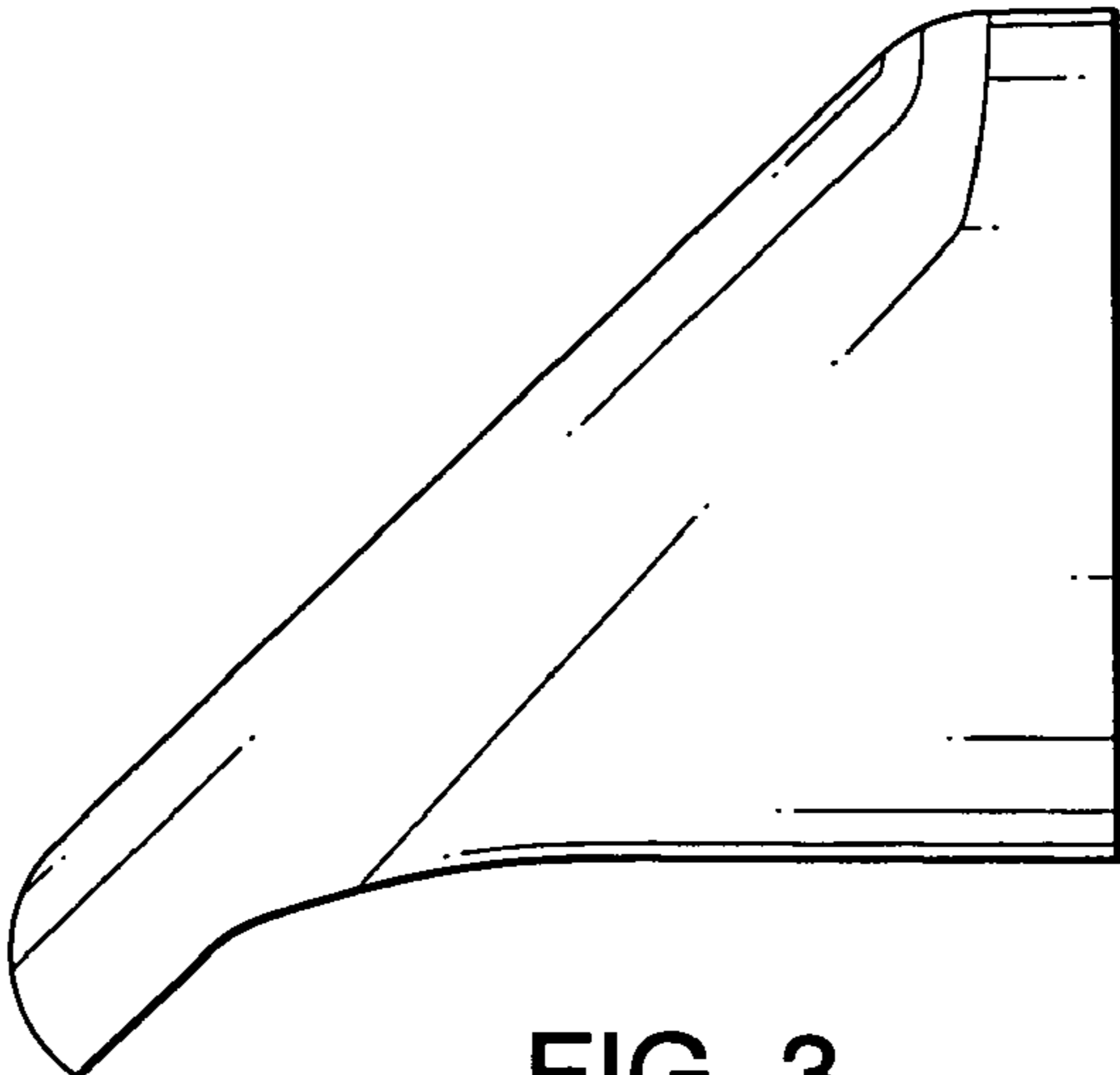

FIG. 3

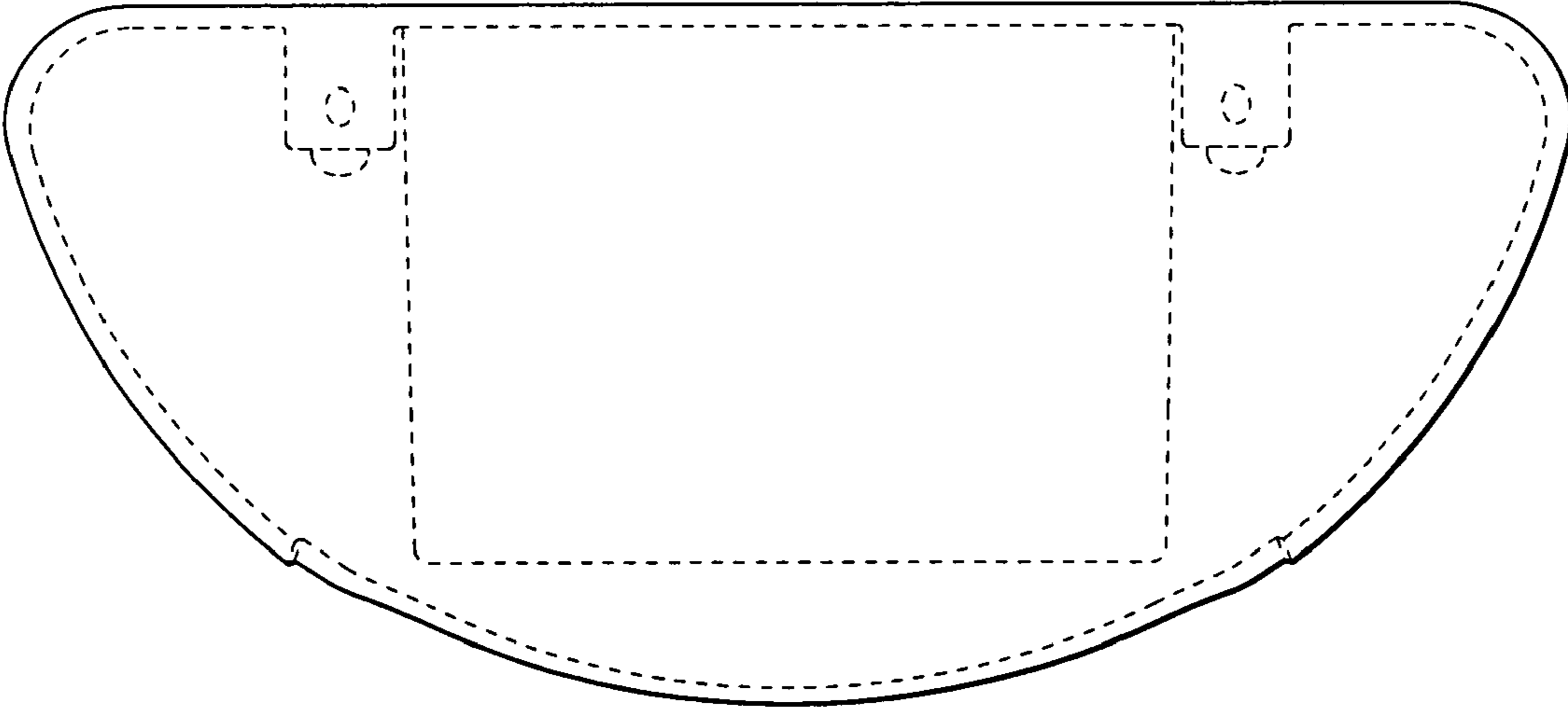

FIG. 4

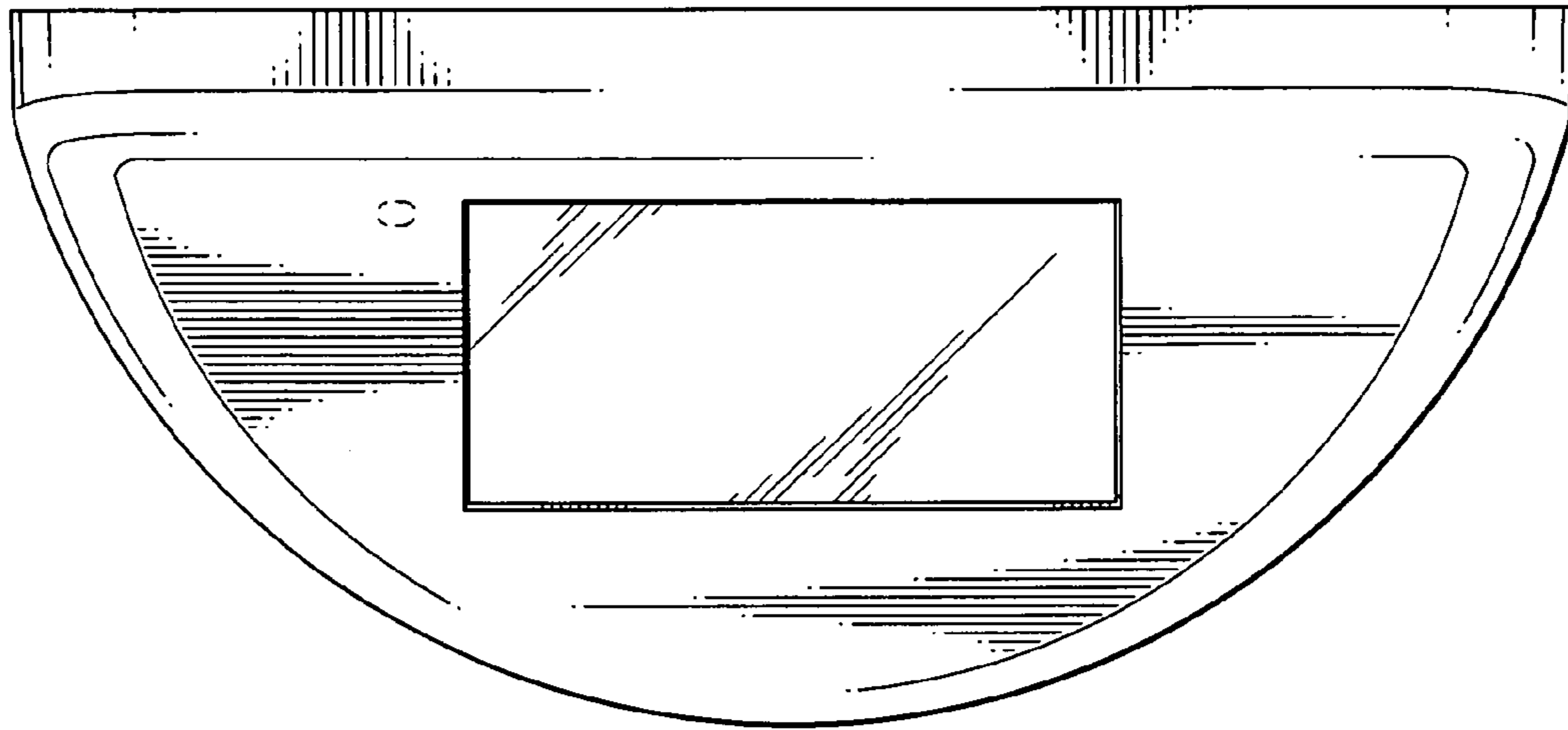

FIG. 5

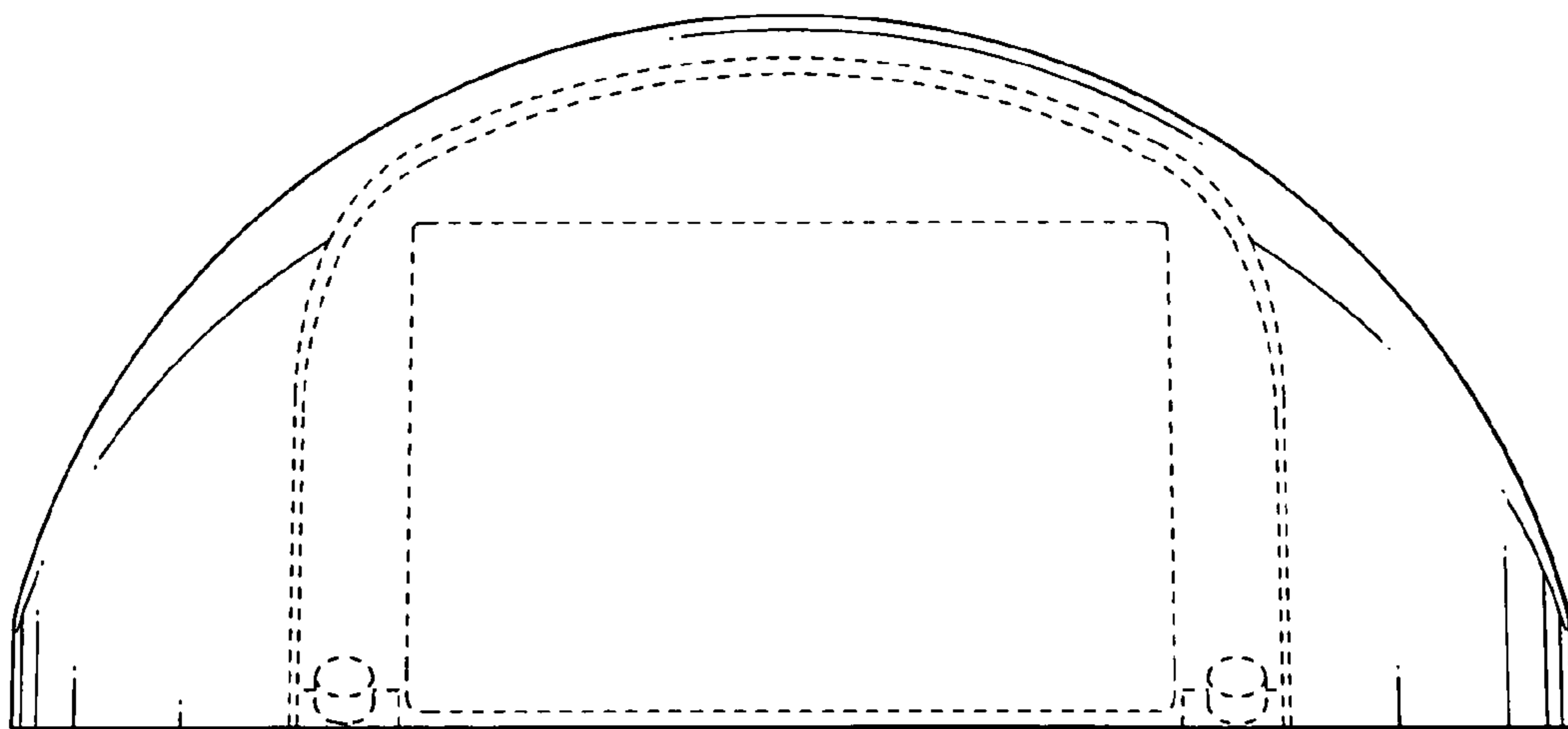

FIG. 6