



US00D586013S

(12) **United States Design Patent**
Hsu

(10) **Patent No.:** **US D586,013 S**

(45) **Date of Patent:** **** Feb. 3, 2009**

(54) **VEHICLE REAR LIGHT UNIT**

Primary Examiner—Marcus A. Jackson
(74) *Attorney, Agent, or Firm*—Alexander Chen, Esq.

(76) **Inventor:** **Hong Ming Hsu**, No 152, Sec 2, Funong
St. East District, Tainan City, 701 (TW)

(57) **CLAIM**

(**) **Term:** **14 Years**

The ornamental design for an vehicle rear light unit, as shown and described.

(21) **Appl. No.:** **29/320,632**

(22) **Filed:** **Jul. 1, 2008**

DESCRIPTION

(51) **LOC (9) Cl.** **26-06**

(52) **U.S. Cl.** **D26/28**

(58) **Field of Classification Search** D26/28-36;
362/459-468, 475-478, 485-487

FIG. 1 is perspective view from the front right of an vehicle rear light unit. The drawings and descriptions represent the right side embodiment. The design also contemplates a mirror symmetrical embodiment on the left side of the vehicle. The dash line included denotes environment and is not part of the claimed design.

See application file for complete search history.

FIG. 2 is a front elevation view thereof;

(56) **References Cited**

FIG. 3 is a right elevation view thereof;

U.S. PATENT DOCUMENTS

FIG. 4 is a top view thereof;

D542,445 S * 5/2007 Matsunami D26/28

FIG. 5 is an exploded perspective view from the front right thereof; and,

D550,380 S * 9/2007 Lin D26/28

FIG. 6 is an exploded front elevation view thereof.

D562,477 S * 2/2008 Hsu D26/28

D570,015 S * 5/2008 Hsu D26/28

* cited by examiner

1 Claim, 6 Drawing Sheets

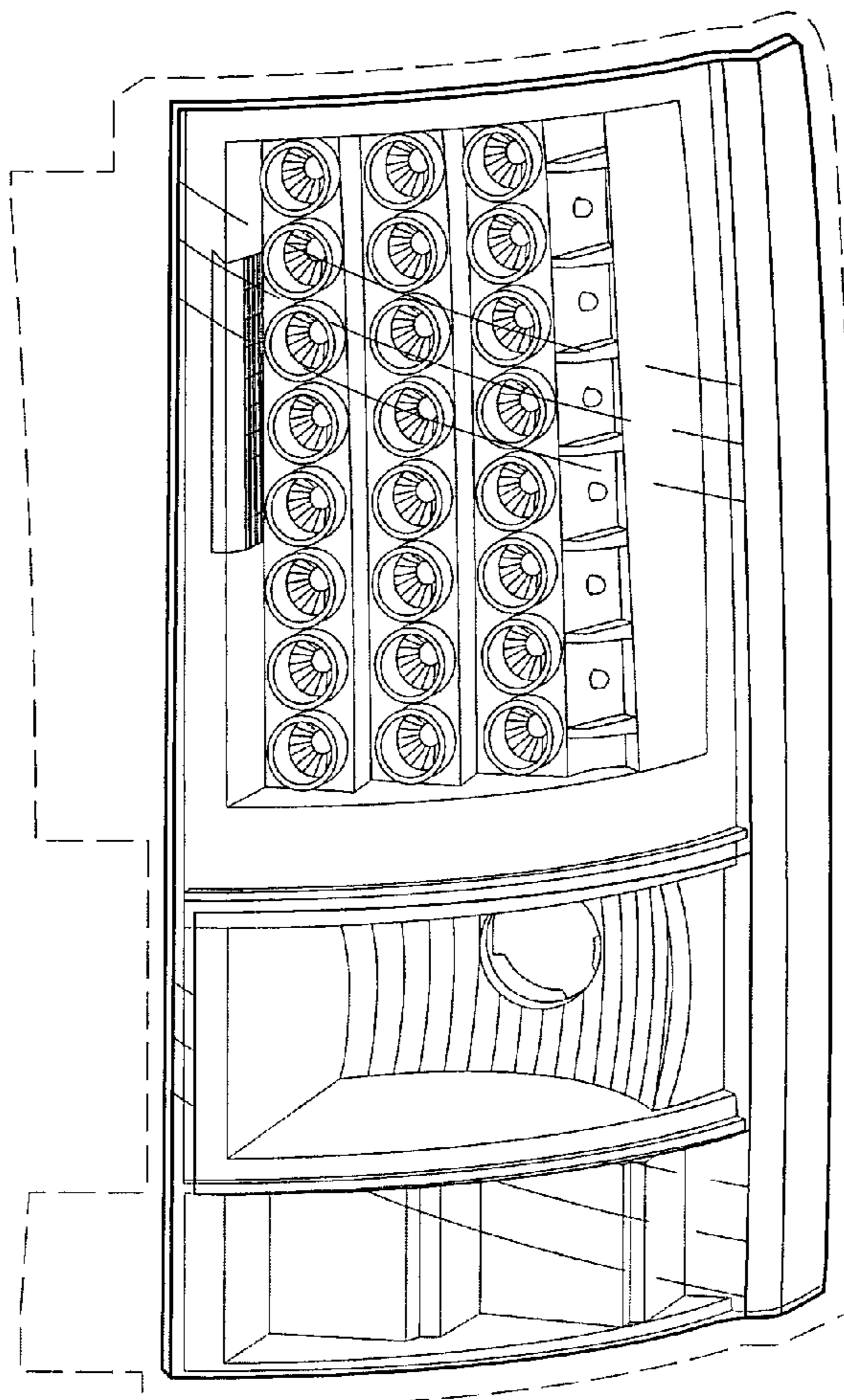

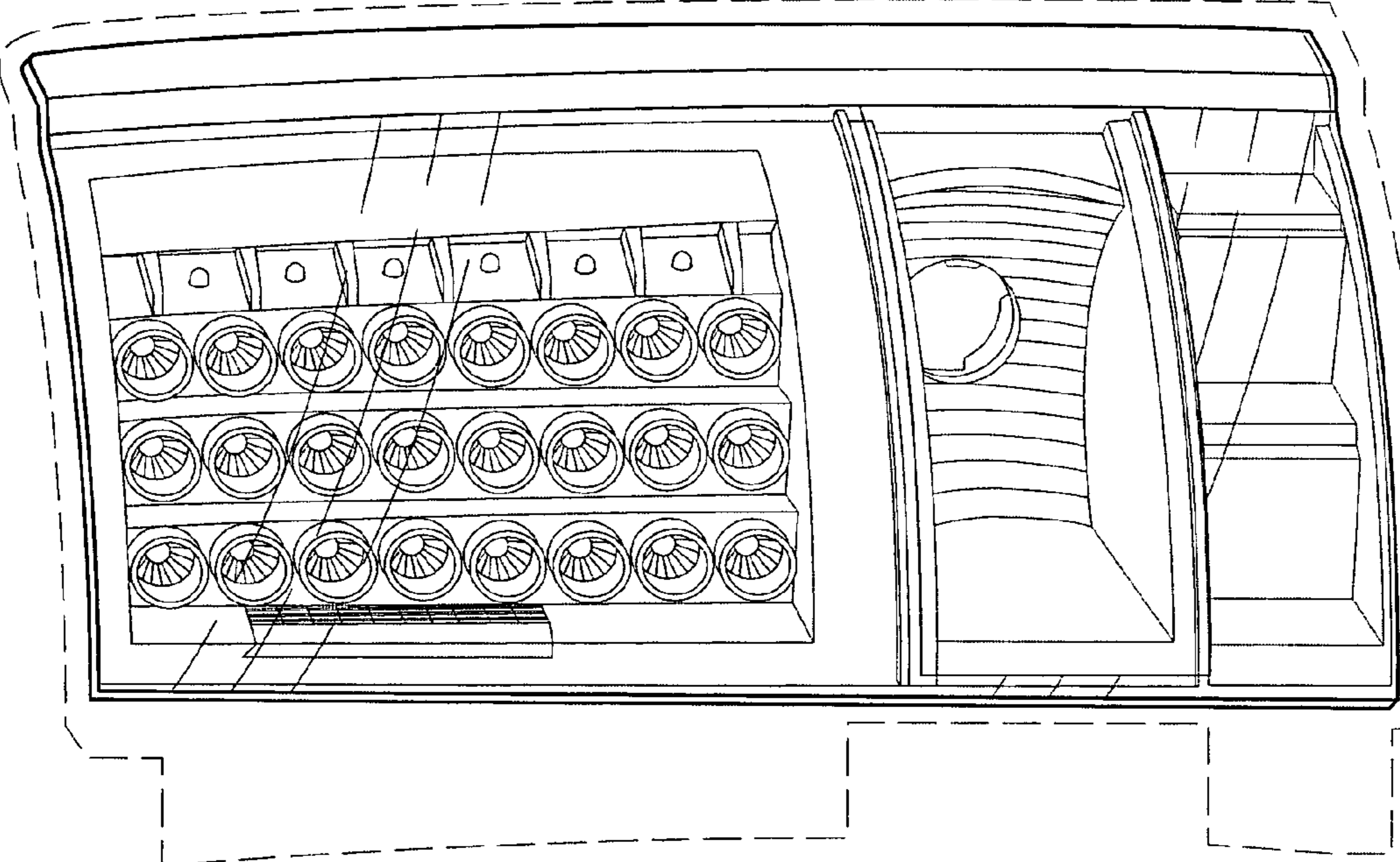

Fig. 1

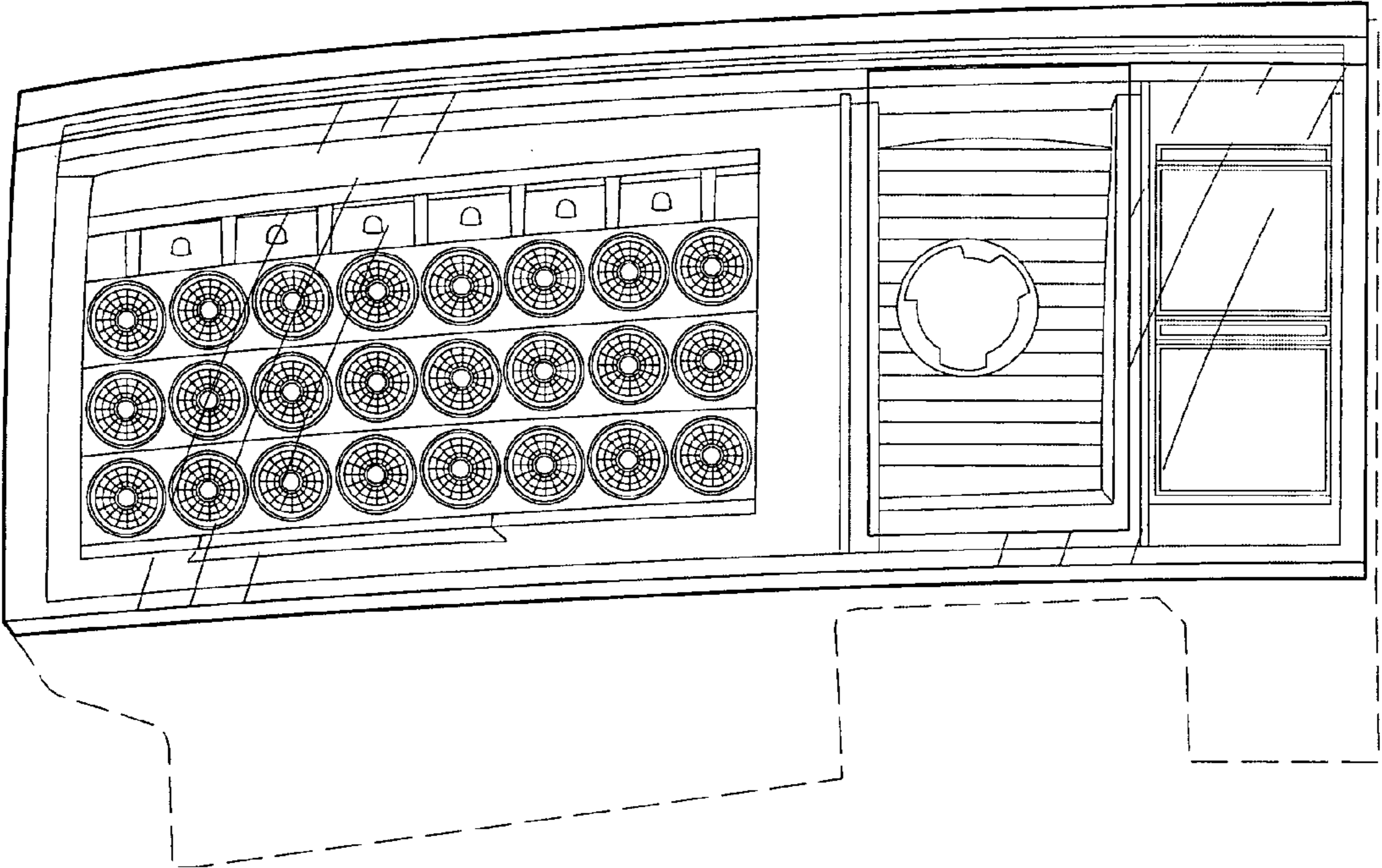

Fig. 2

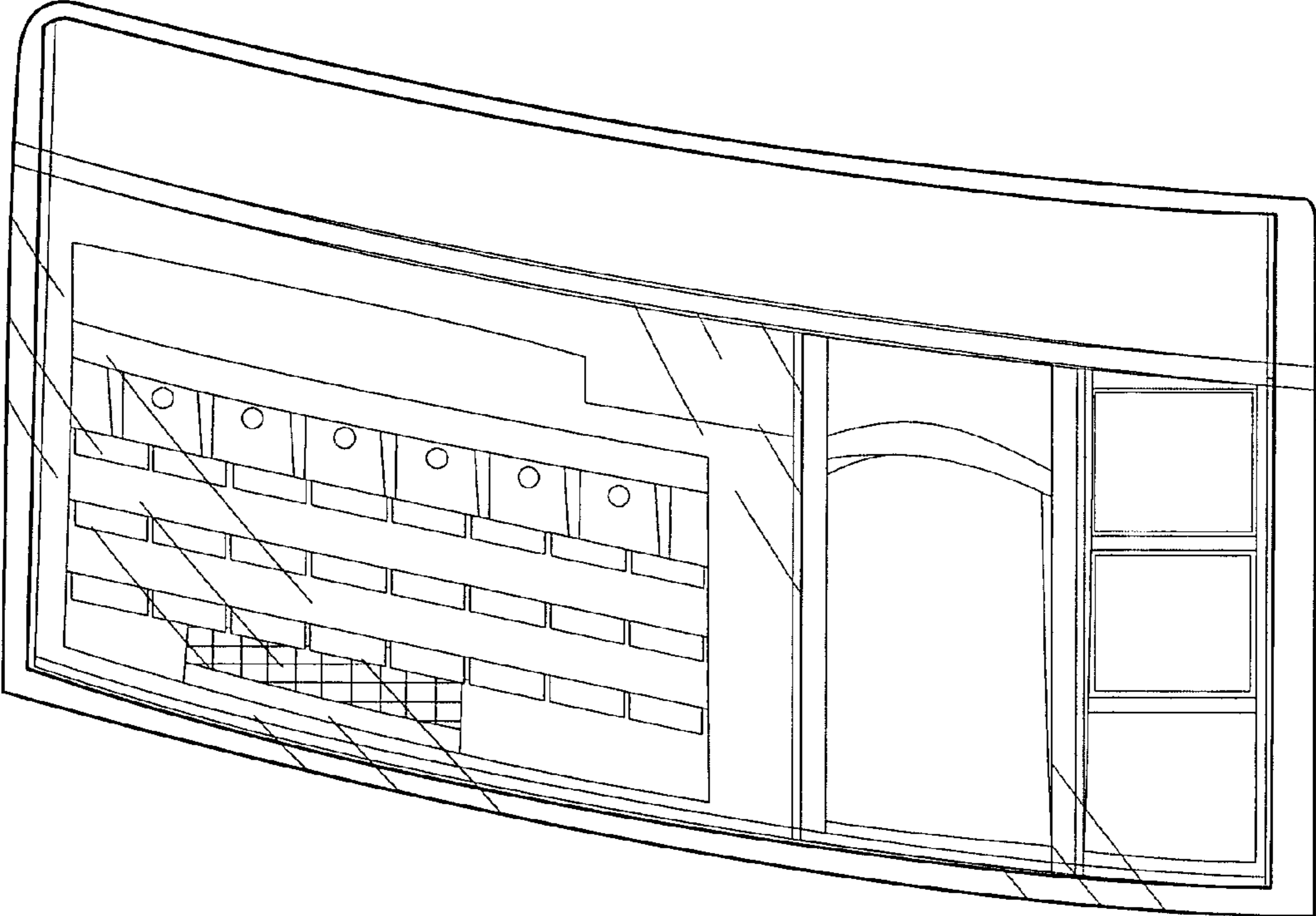

Fig. 3

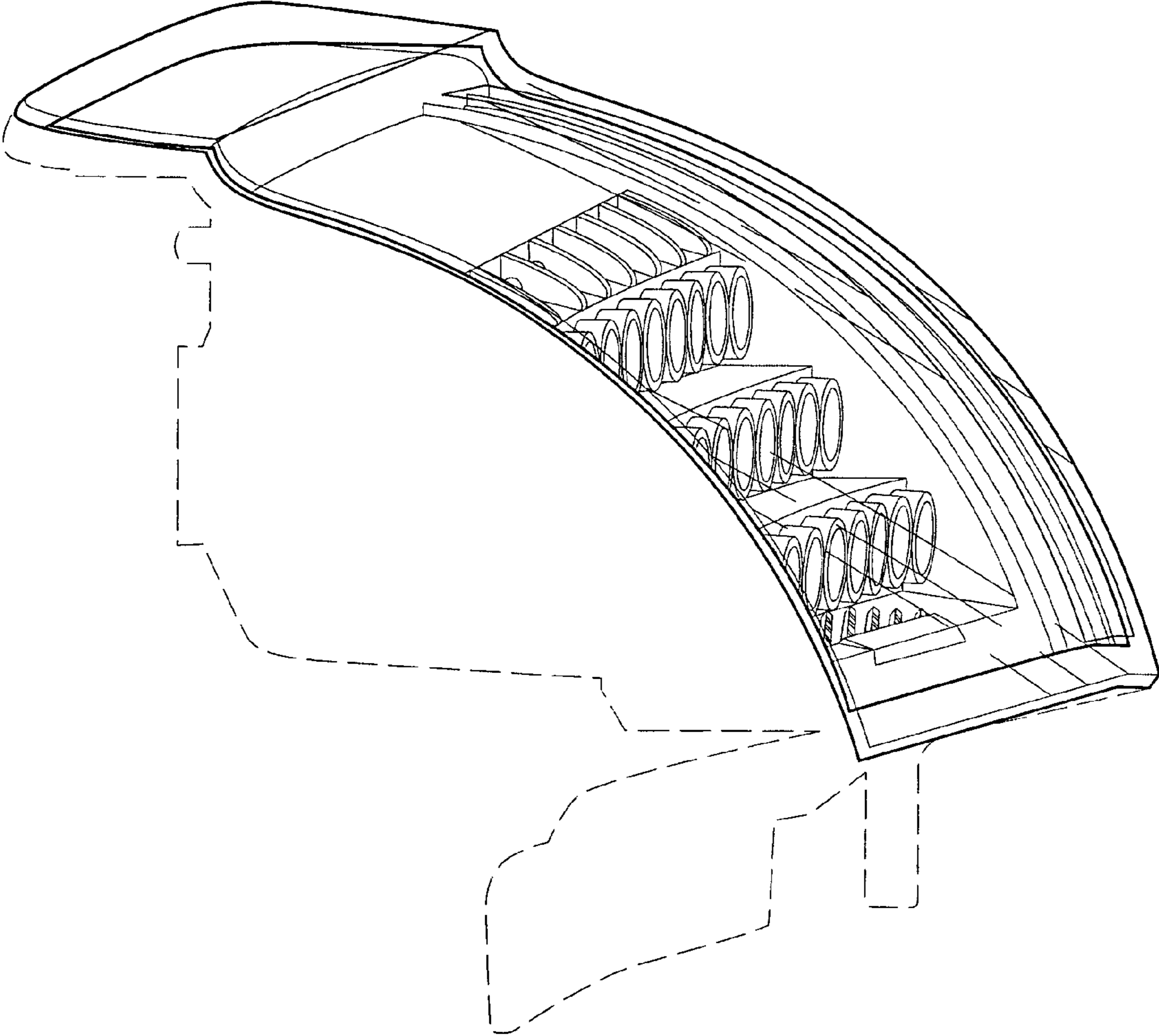

Fig. 4

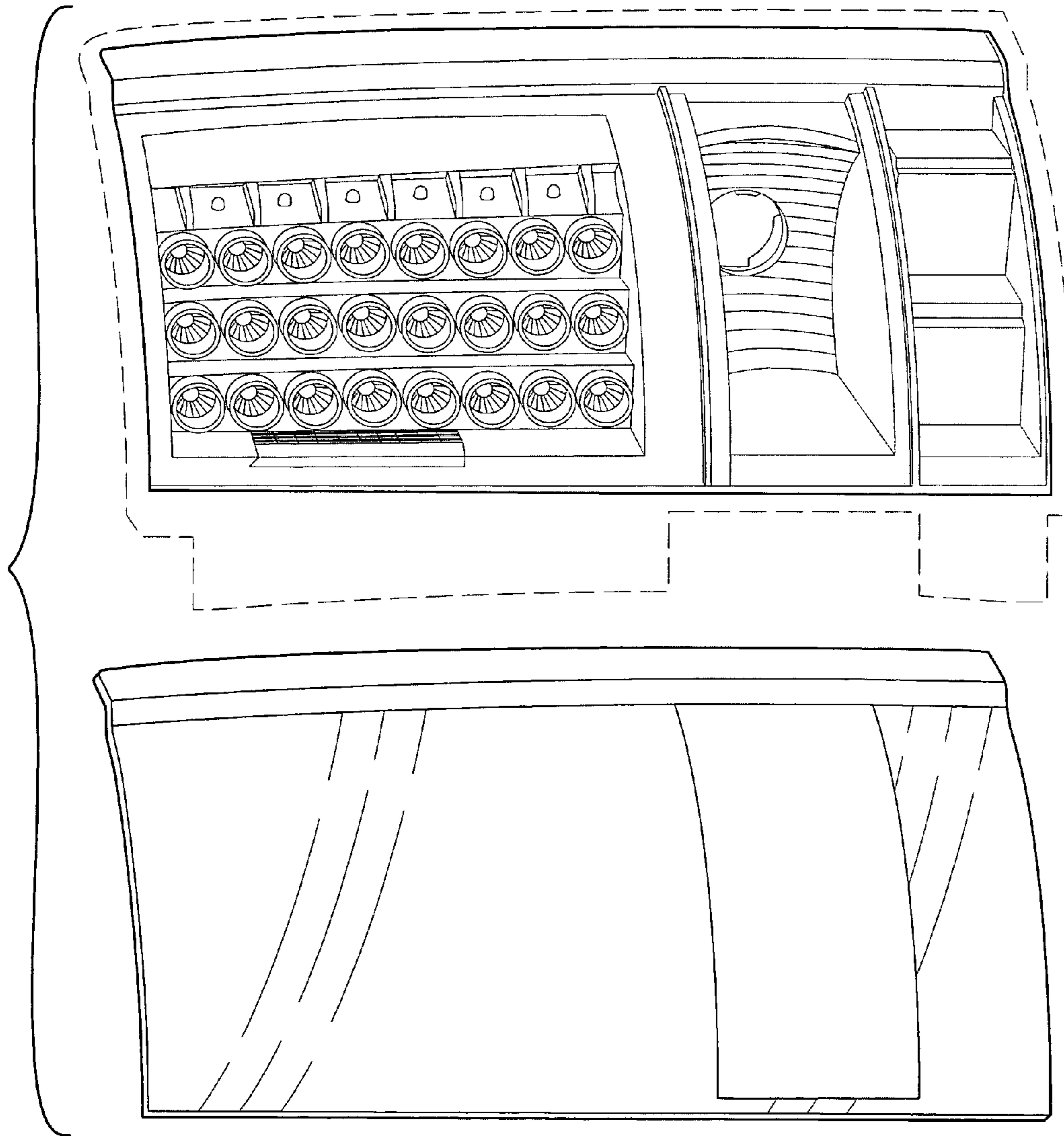

Fig. 5

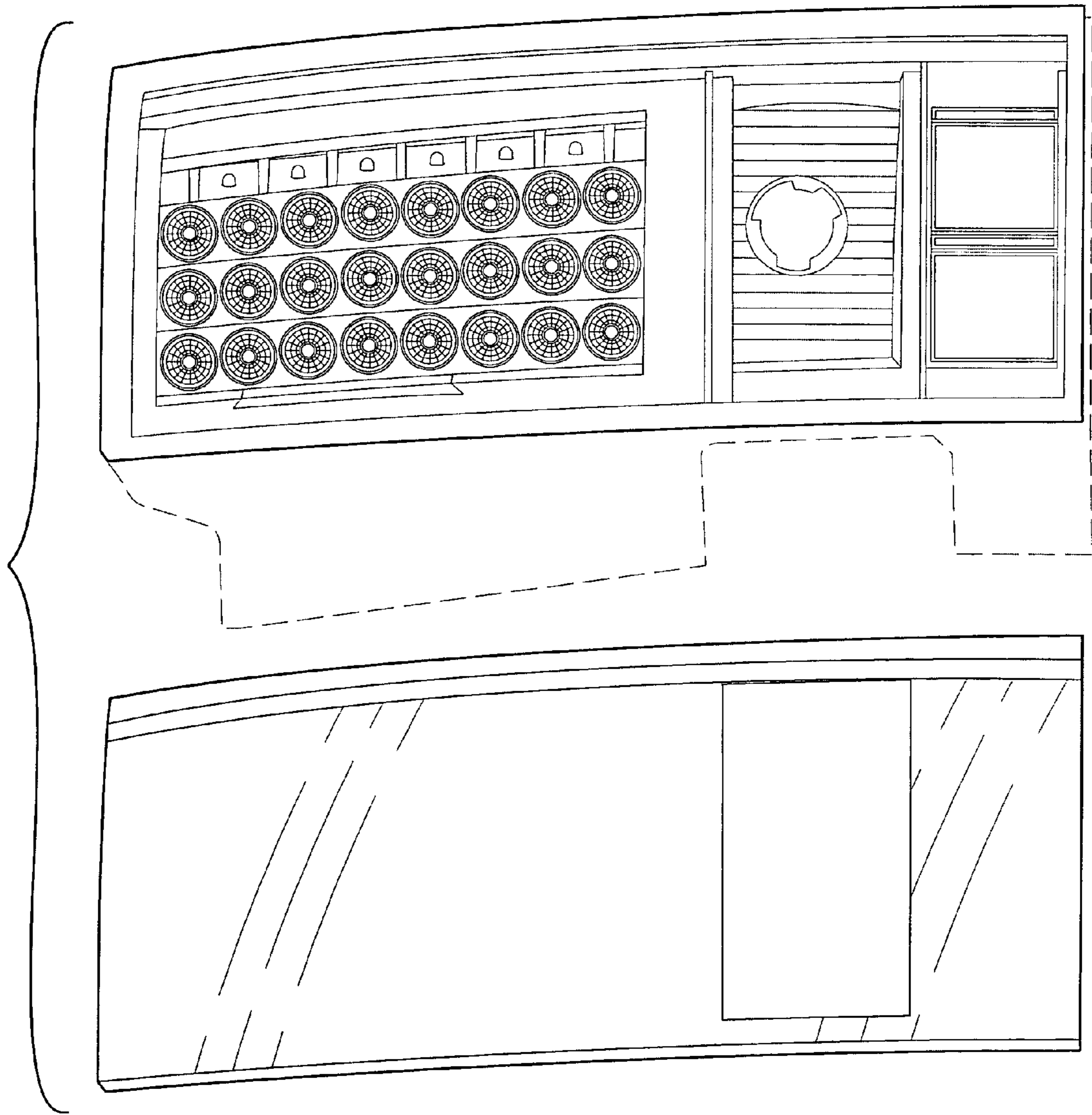

Fig. 6