



US00D585954S

(12) **United States Design Patent**  
**Bubits**

(10) **Patent No.:** **US D585,954 S**

(45) **Date of Patent:** **\*\* Feb. 3, 2009**

(54) **TACTICAL FRONT STOCKS**

(75) Inventor: **Wilhelm Bubits**, Brunn am Gebirge  
(AT)

(73) Assignee: **Caracal International L.L.C.**, Abu  
Dhabi (AE)

(\*\*) Term: **14 Years**

(21) Appl. No.: **29/275,050**

(22) Filed: **Dec. 11, 2006**

(30) **Foreign Application Priority Data**

Jun. 12, 2006 (AT) ..... 673/2006  
Jun. 12, 2006 (AT) ..... 674/2006  
Jun. 12, 2006 (AT) ..... 675/2006

(51) **LOC (9) Cl.** ..... **22-01**

(52) **U.S. Cl.** ..... **D22/108**

(58) **Field of Classification Search** ..... D22/108,  
D22/103-104, 109-110, 199; 42/71.01,  
42/71.02, 72-74, 75.01, 70.07; 89/1.42,  
89/37.04, 33.01; 362/110

See application file for complete search history.

(56) **References Cited**

**U.S. PATENT DOCUMENTS**

D110,729 S \* 8/1938 Mossberg ..... D22/108  
D277,029 S \* 1/1985 Blake et al. .... D24/145  
D286,669 S \* 11/1986 Ballard et al. .... D22/108  
D296,810 S \* 7/1988 Geiser, Jr. .... D22/103  
D297,855 S \* 9/1988 Ruger et al. .... D22/108  
4,777,948 A \* 10/1988 Wright ..... 606/83

5,864,978 A \* 2/1999 McRary et al. .... 42/71.01  
D443,912 S \* 6/2001 Henderson ..... D22/108  
6,609,322 B1 \* 8/2003 Michelson ..... 42/71.02  
6,952,896 B2 \* 10/2005 Davis ..... 42/71.01

\* cited by examiner

*Primary Examiner*—Ian Simmons

*Assistant Examiner*—Wan Laymon

(74) *Attorney, Agent, or Firm*—Abelman, Frayne & Schwab

(57) **CLAIM**

The ornamental design for a tactical front stock, as shown and described.

**DESCRIPTION**

FIG. 1 is a left side elevational view of a tactical front stock showing my new design;

FIG. 2 is a right side elevational view thereof;

FIG. 3 is a top plan view thereof;

FIG. 4 is a bottom plan view thereof;

FIG. 5 is a front elevational view thereof;

FIG. 6 is a rear elevational view thereof;

FIG. 7 is a left side elevational view of second embodiment of a tactical front stock showing my new design;

FIG. 8 is a right side elevational view thereof;

FIG. 9 is a top plan view thereof;

FIG. 10 is a bottom plan view thereof;

FIG. 11 is a front elevational view thereof; and,

FIG. 12 is a rear elevational view thereof.

**1 Claim, 4 Drawing Sheets**

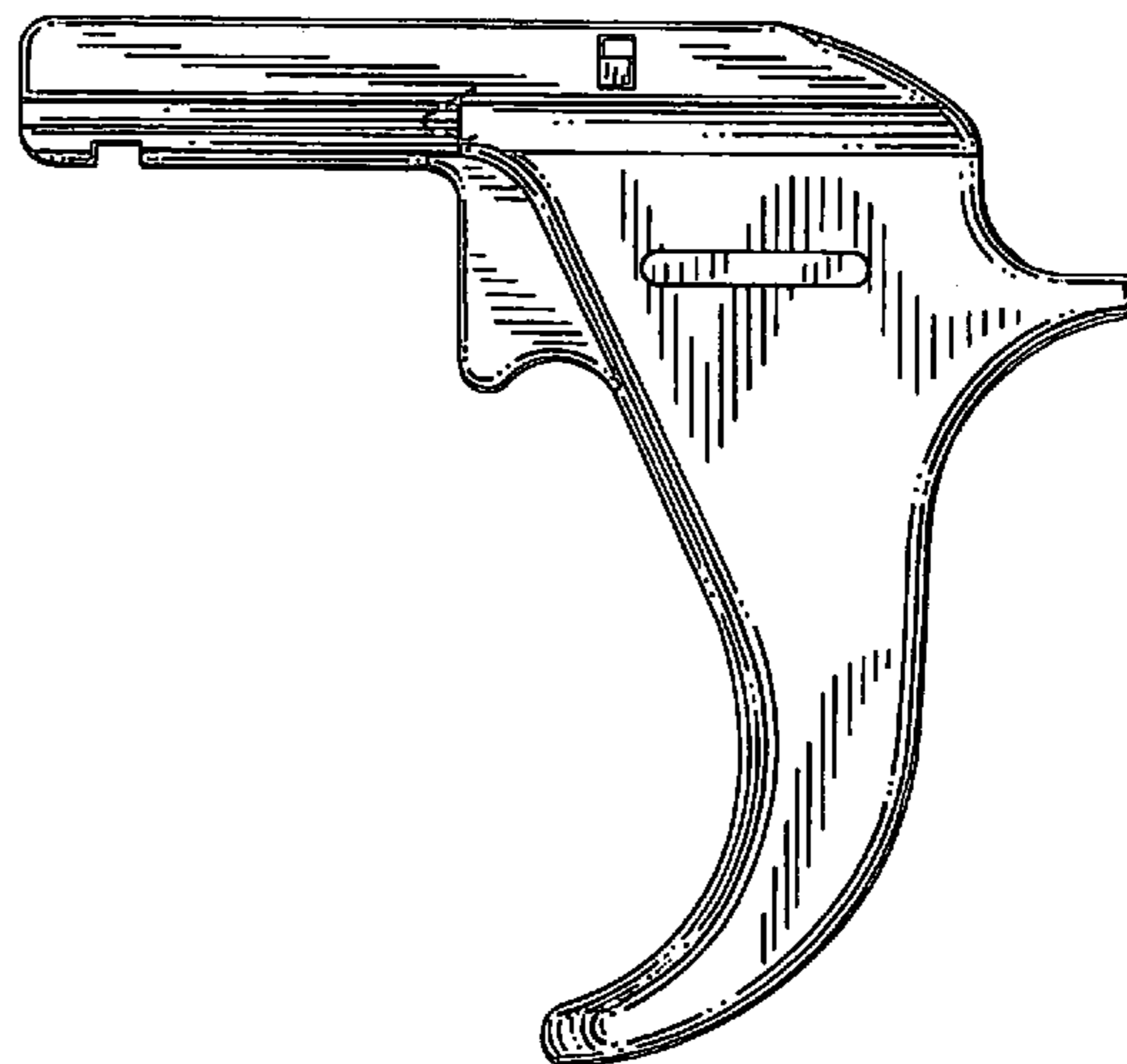
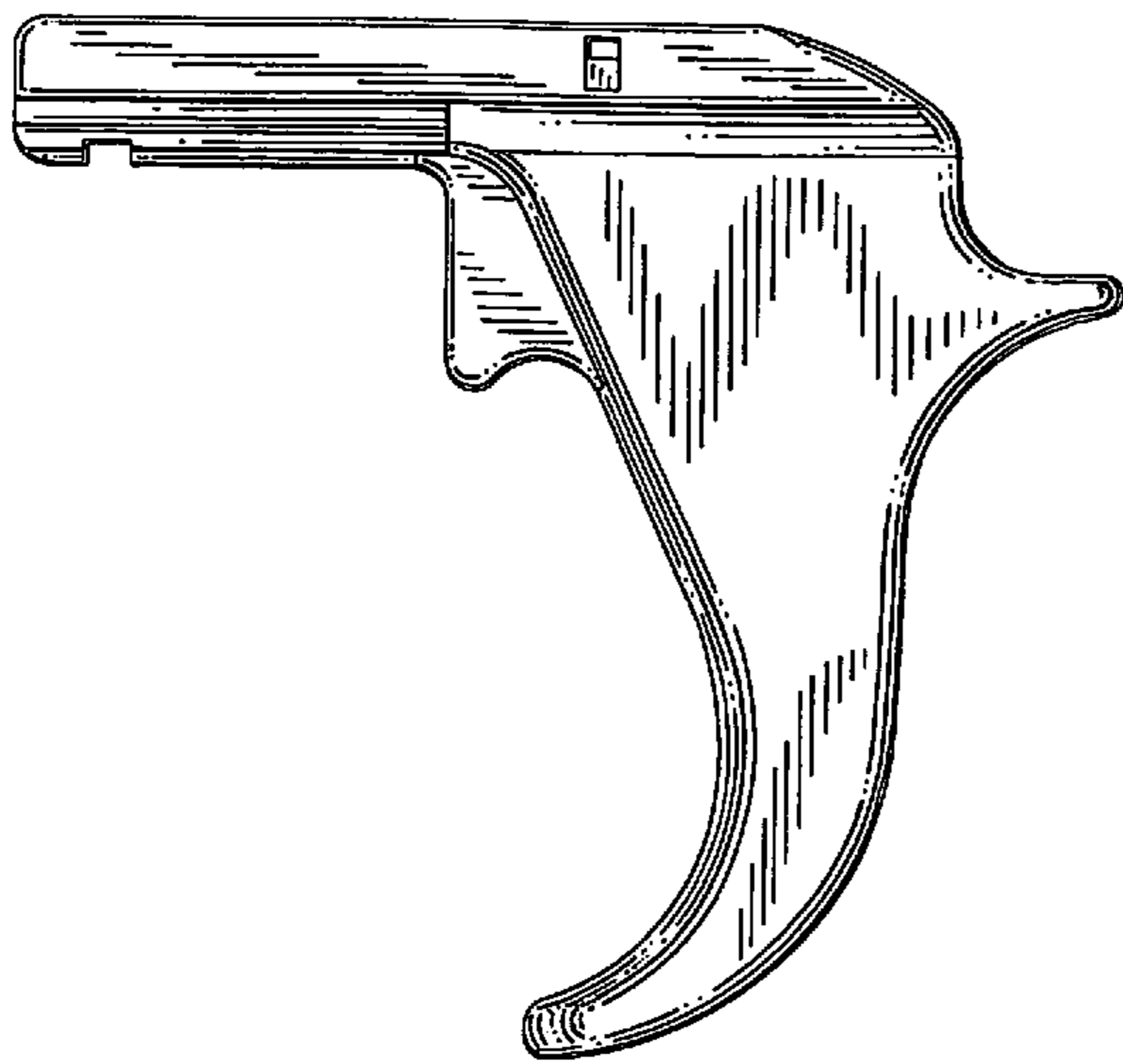

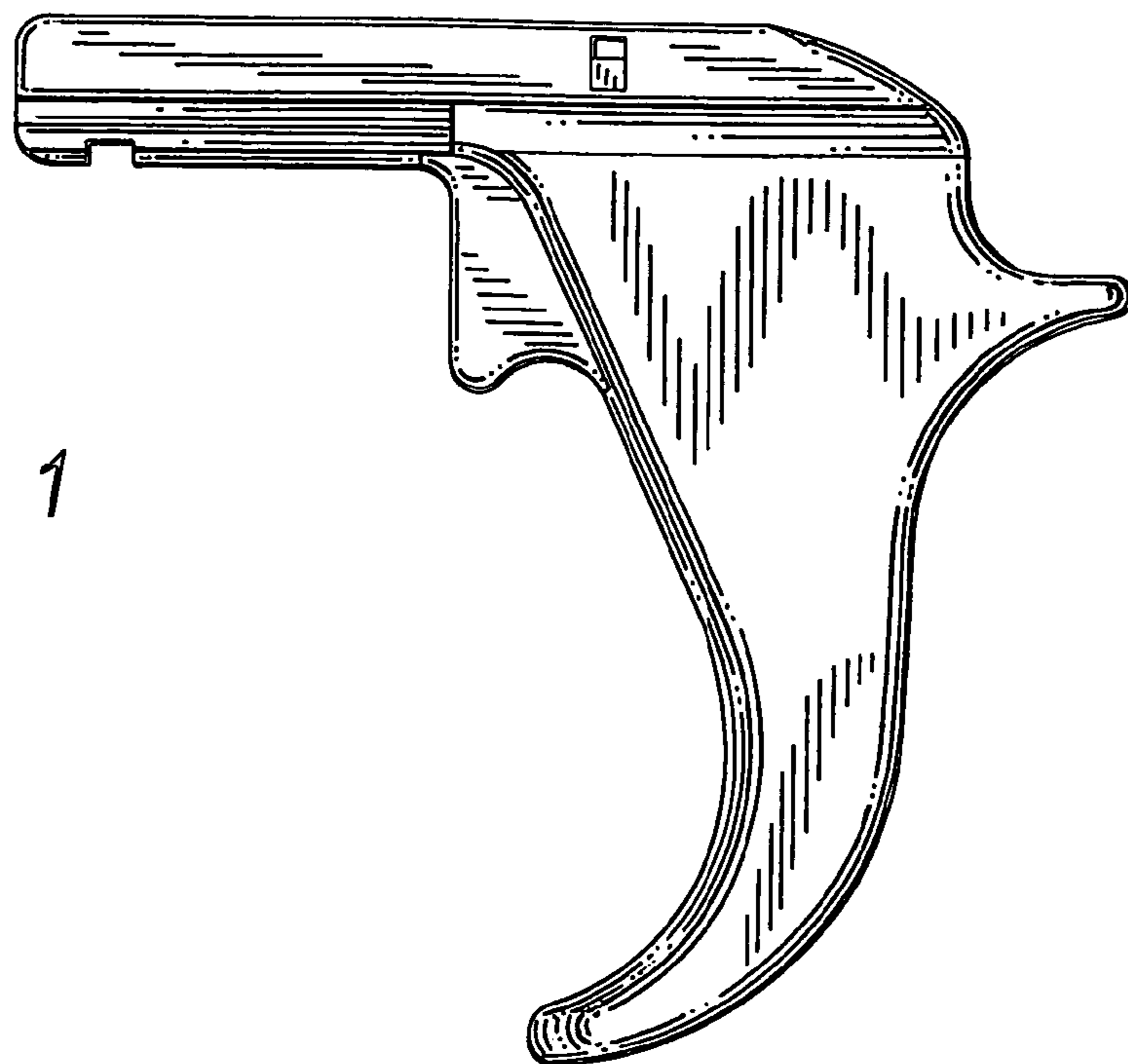

FIG. 1

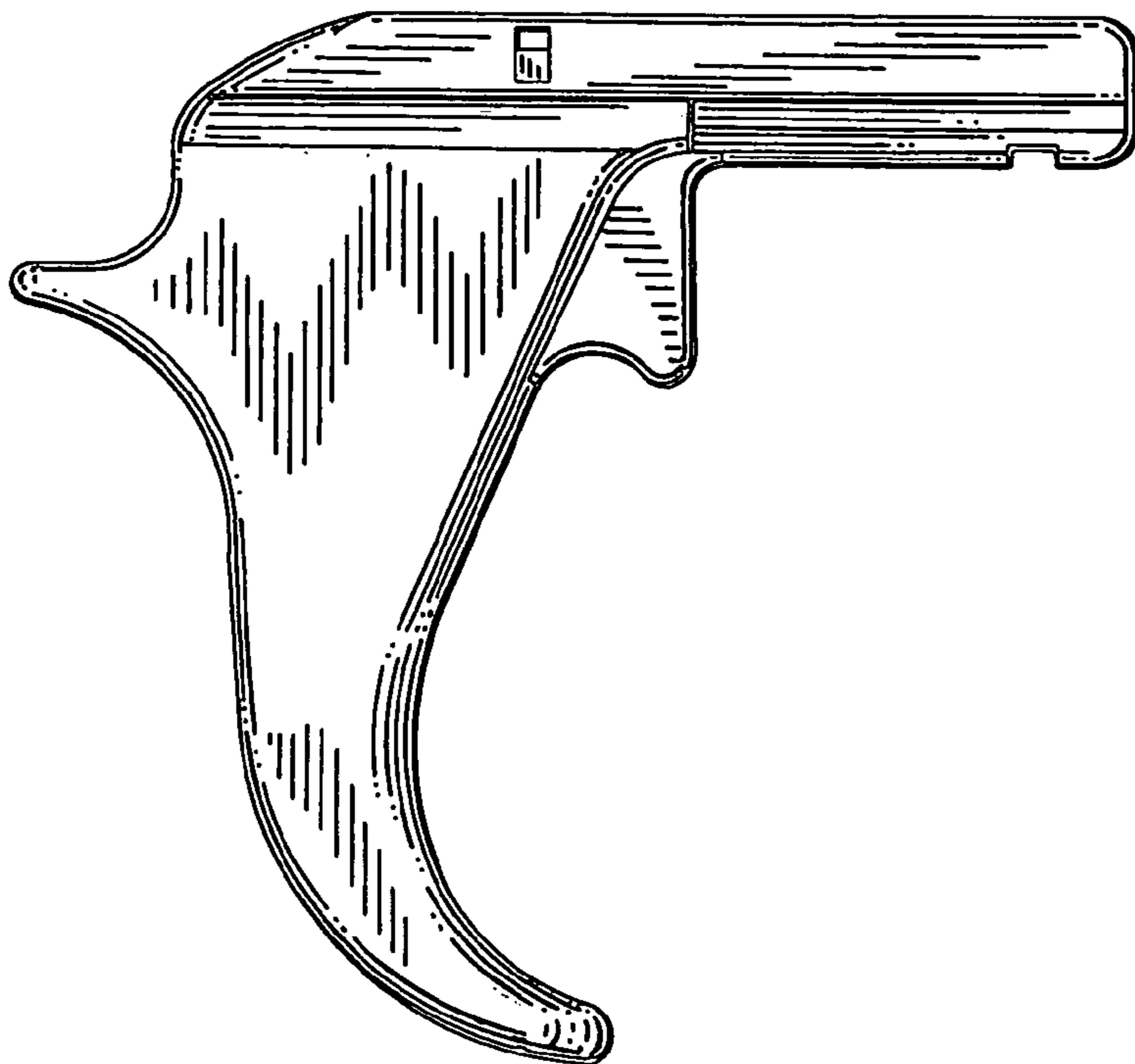

FIG. 2

FIG. 3

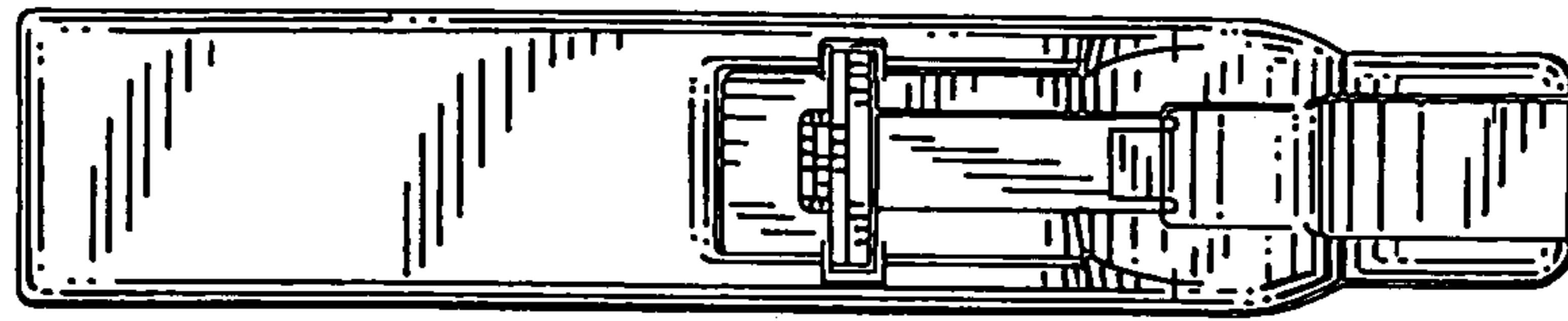

FIG. 4

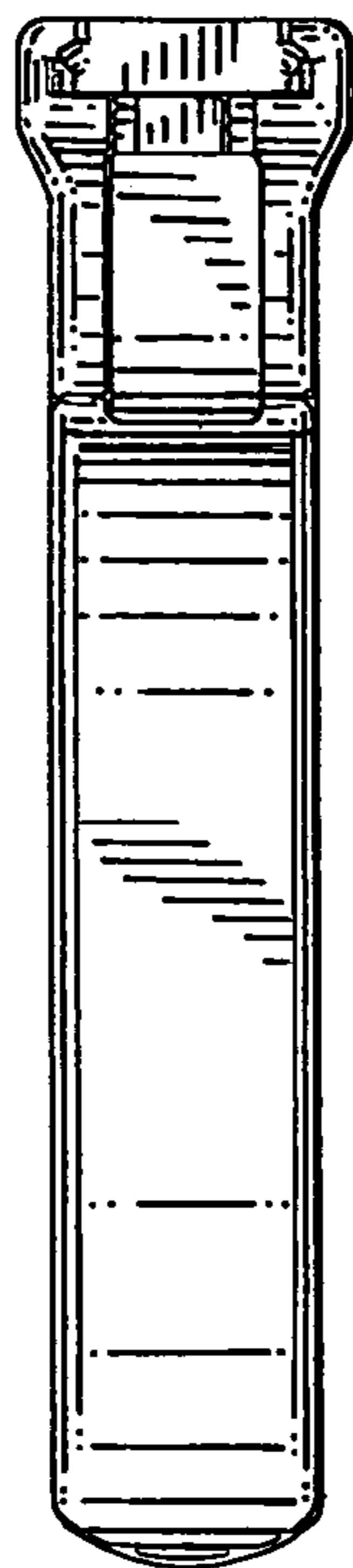
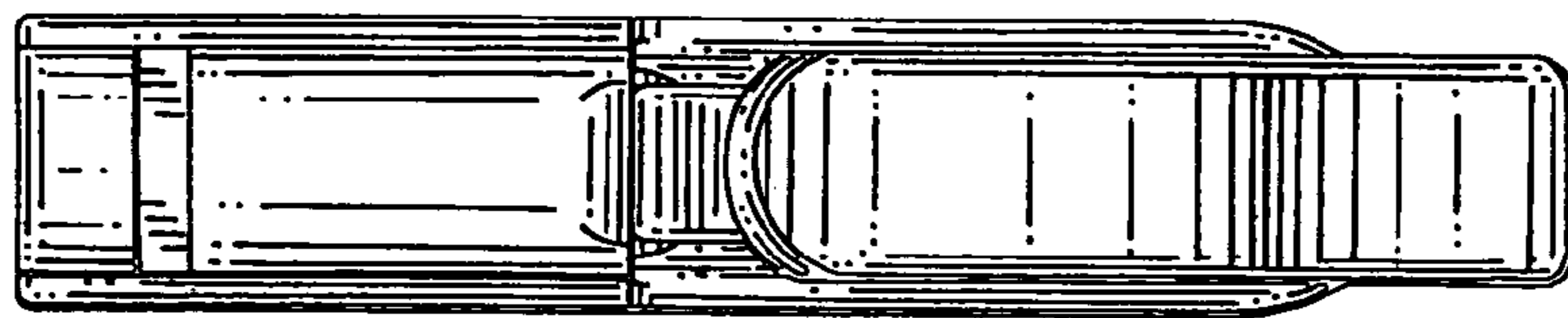

FIG. 5

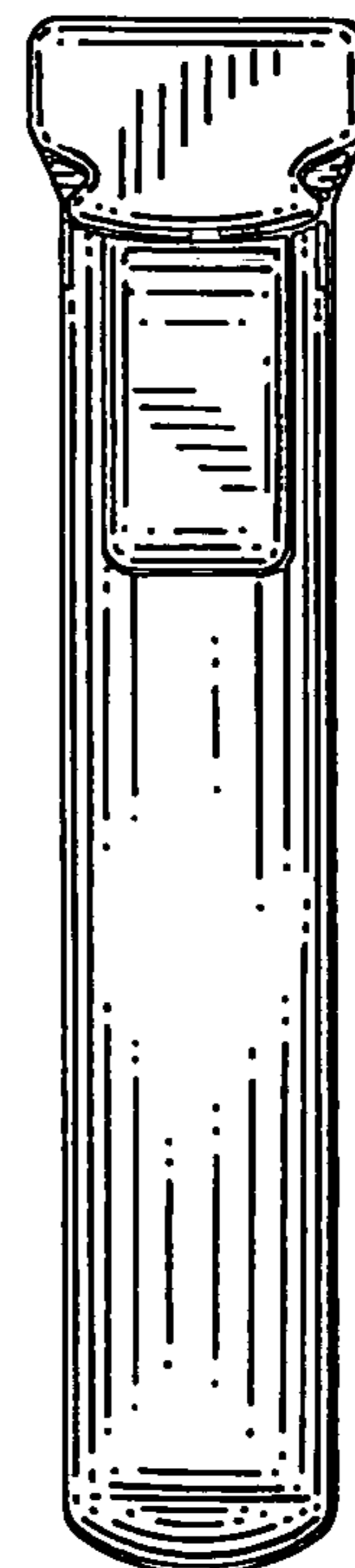
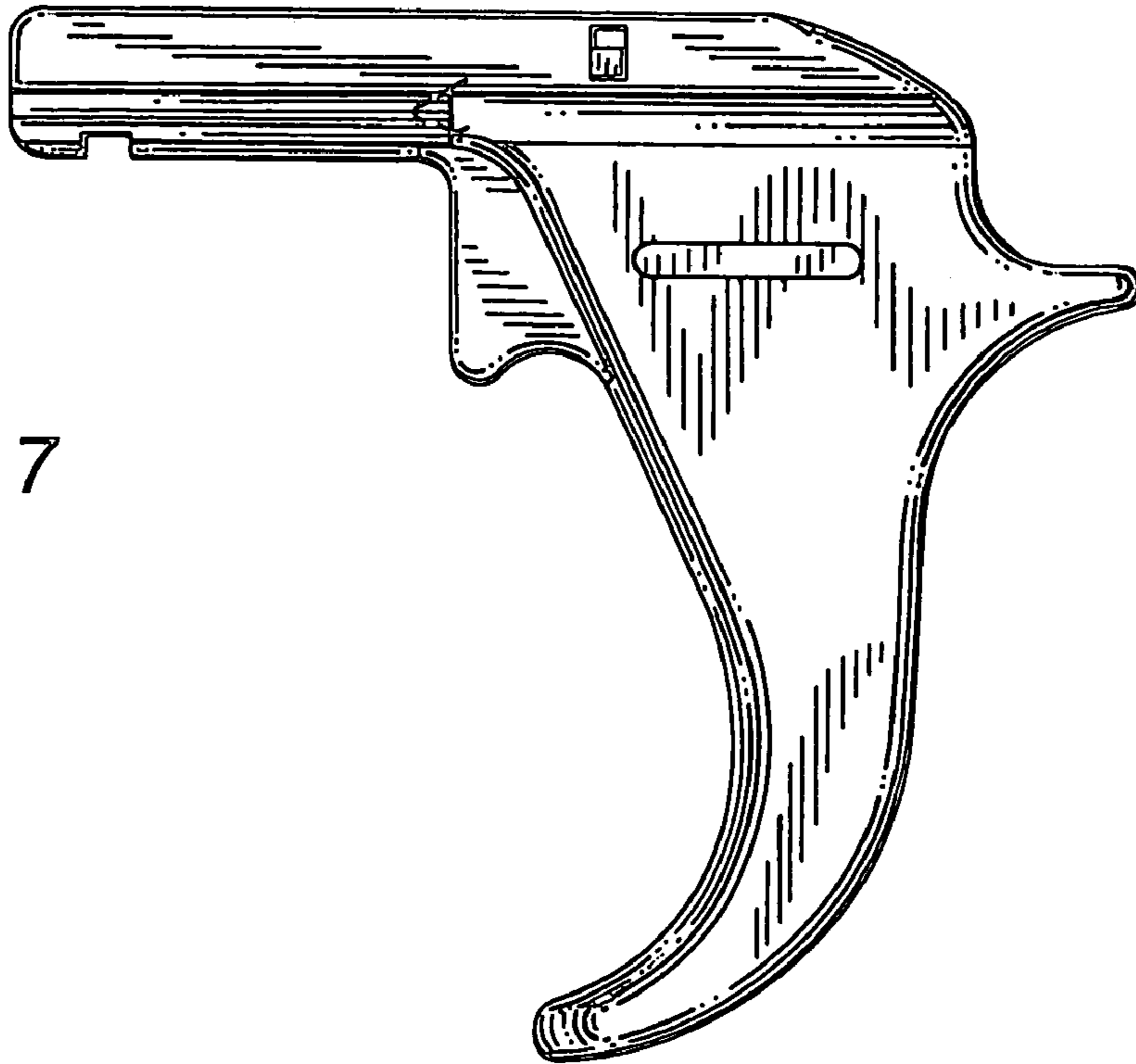
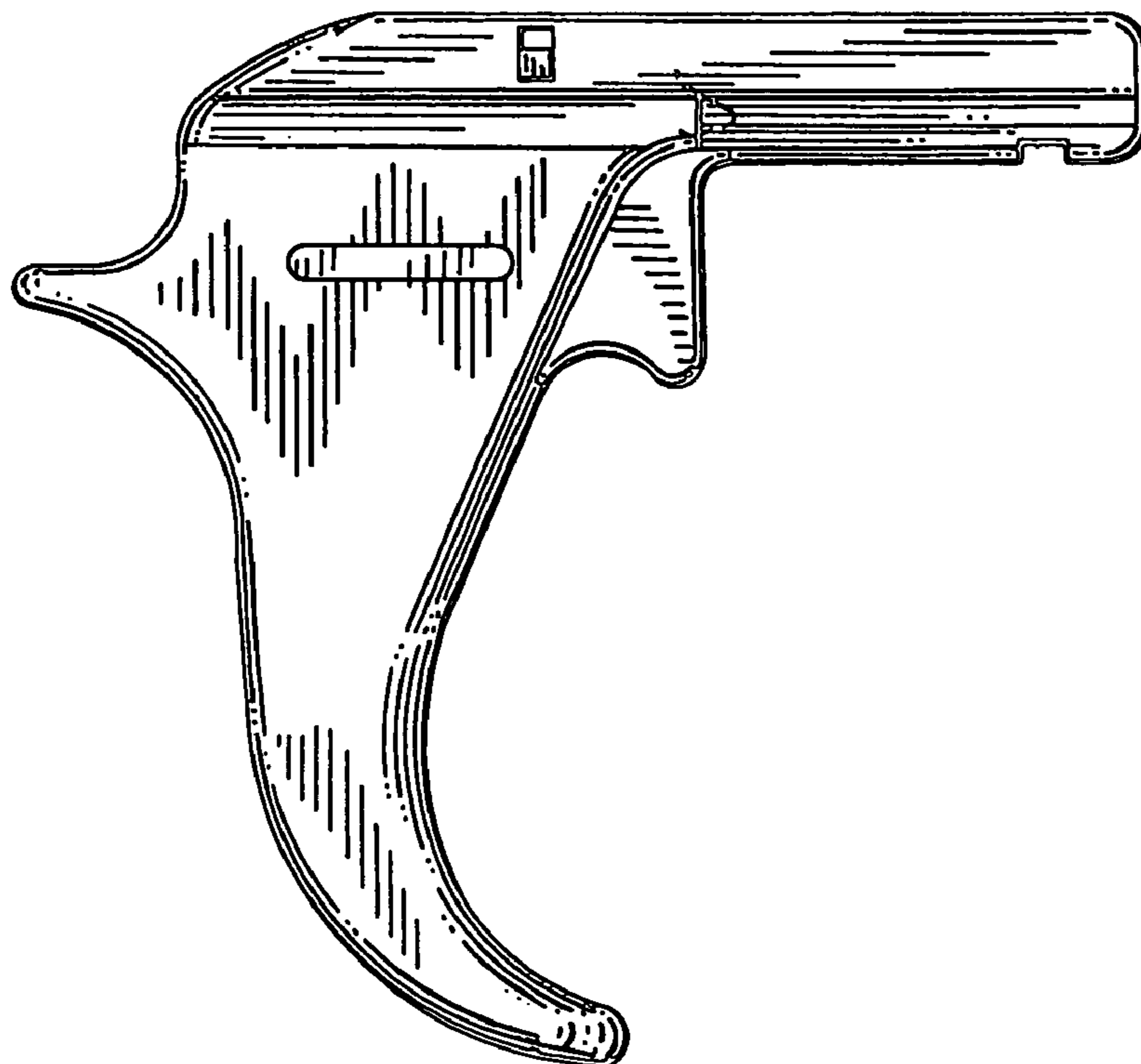

FIG. 6



*FIG. 7*



*FIG. 8*

FIG. 9

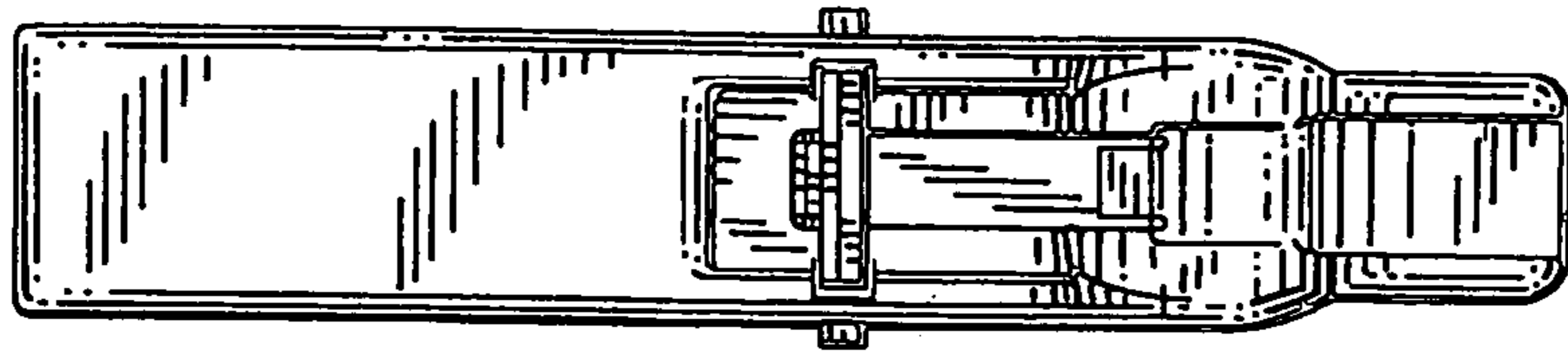

FIG. 10

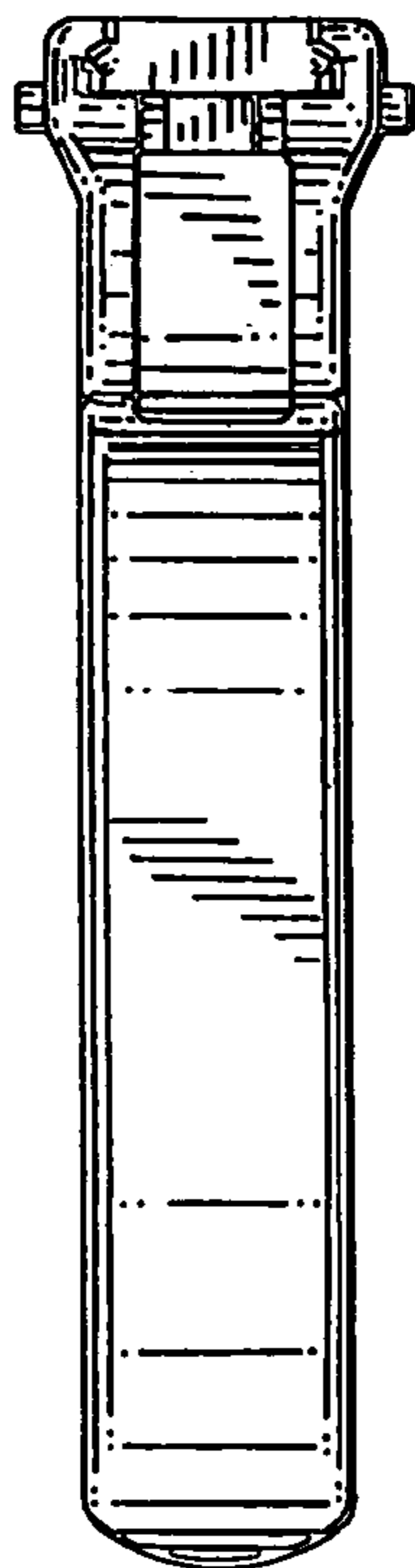
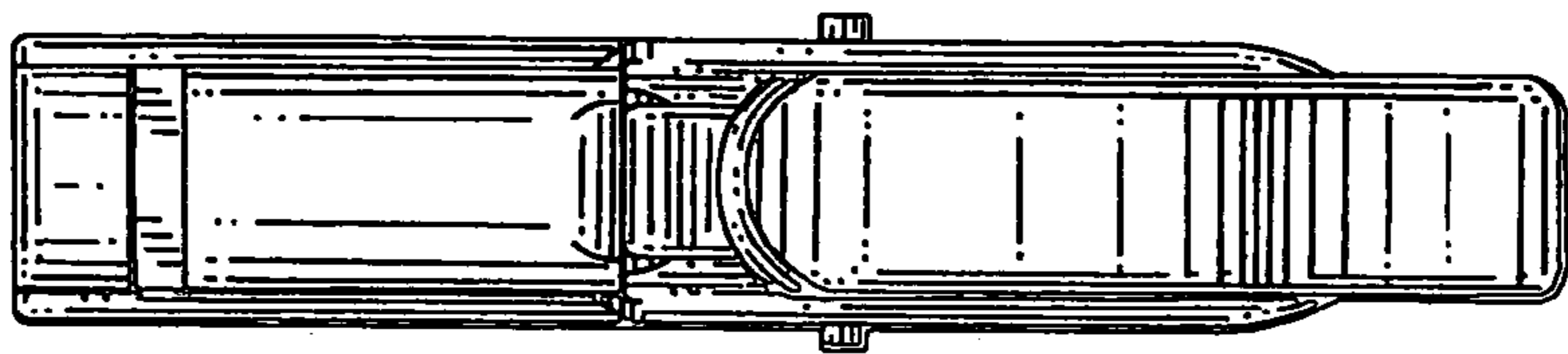

FIG. 11

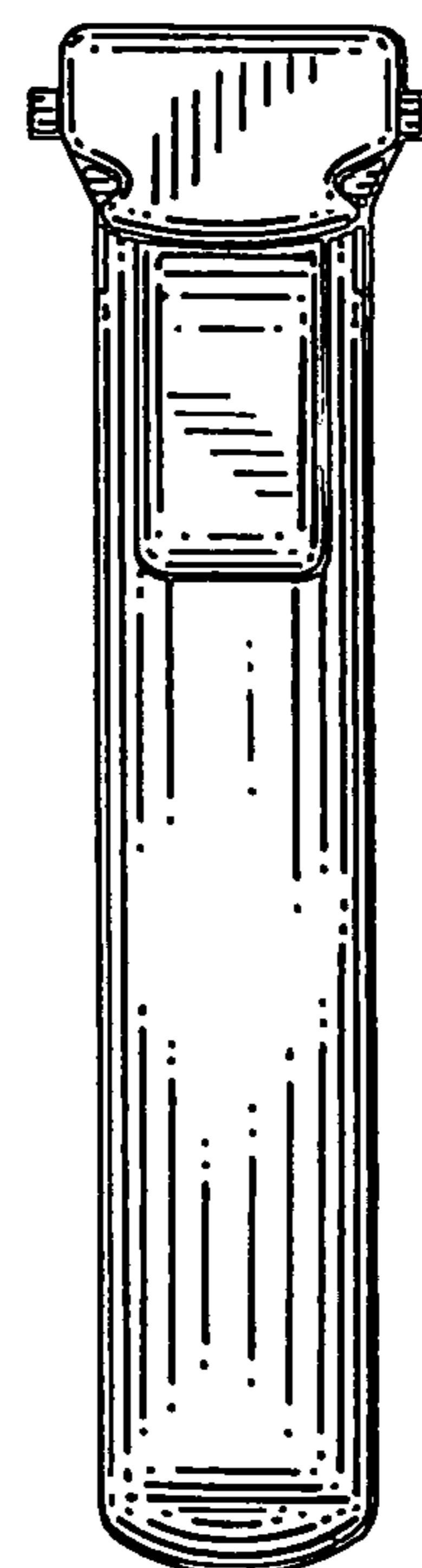

FIG. 12