



US00D585944S

(12) **United States Design Patent**
Lee

(10) **Patent No.:** **US D585,944 S**

(45) **Date of Patent:** **** Feb. 3, 2009**

(54) **TAG HOLDER**

(76) Inventor: **Han Young Lee**, 1032 Summertree Cir.,
Plano, TX (US) 75025

(**) Term: **14 Years**

(21) Appl. No.: **29/288,191**

(22) Filed: **Jun. 1, 2007**

(51) **LOC (9) Cl.** **20-03**

(52) **U.S. Cl.** **D20/43**

(58) **Field of Classification Search** D20/10,
D20/11, 22, 23, 27, 28, 40, 43, 99; 40/27,
40/124.01, 299.01, 300, 306, 310, 330, 360,
40/538, 594, 607.13, 607.15, 637, 642.01,
40/642.02, 655, 661.05, 661.11, 662, 664-666,
40/669, 673, 908, 913, 915; 283/56, 81;
24/115 A, 690

See application file for complete search history.

(56) **References Cited**

U.S. PATENT DOCUMENTS

207,694 A *	9/1878	Tunny	24/690
1,477,123 A *	12/1923	Hopkins	40/310
D92,405 S *	6/1934	Klebanow	D20/28
1,971,528 A *	8/1934	Klebanow	40/310
2,099,029 A *	11/1937	McKay	229/74
2,864,188 A *	12/1958	Tierney	40/637
2,881,766 A *	4/1959	Tornsjo	40/360

2,962,824 A *	12/1960	Brooks et al.	40/666
3,225,478 A *	12/1965	Rohmer	40/330
3,974,547 A *	8/1976	Little	24/115 A

* cited by examiner

Primary Examiner—Caron Veynar

Assistant Examiner—Mary Ann Calabrese

(74) *Attorney, Agent, or Firm*—Mark W Handley

(57) **CLAIM**

The ornamental design for a tag holder, as shown and described.

DESCRIPTION

FIG. 1 is a front view of a tag holder embodying my design;
FIG. 2 is a right side view of the tag holder;
FIG. 3 is a rear view of the tag holder;
FIG. 4 is a left side view of the tag holder;
FIG. 5 is a top view of the tag holder;
FIG. 6 is a bottom view of the tag holder;
FIG. 7 is a front view of the tag holder shown in use mounted to a tag; and,
FIG. 8 is a right side view of the tag holder shown in use mounted to the tag.

The broken lines are shown for illustrative purposes only and form no part of the claimed design.

1 Claim, 2 Drawing Sheets

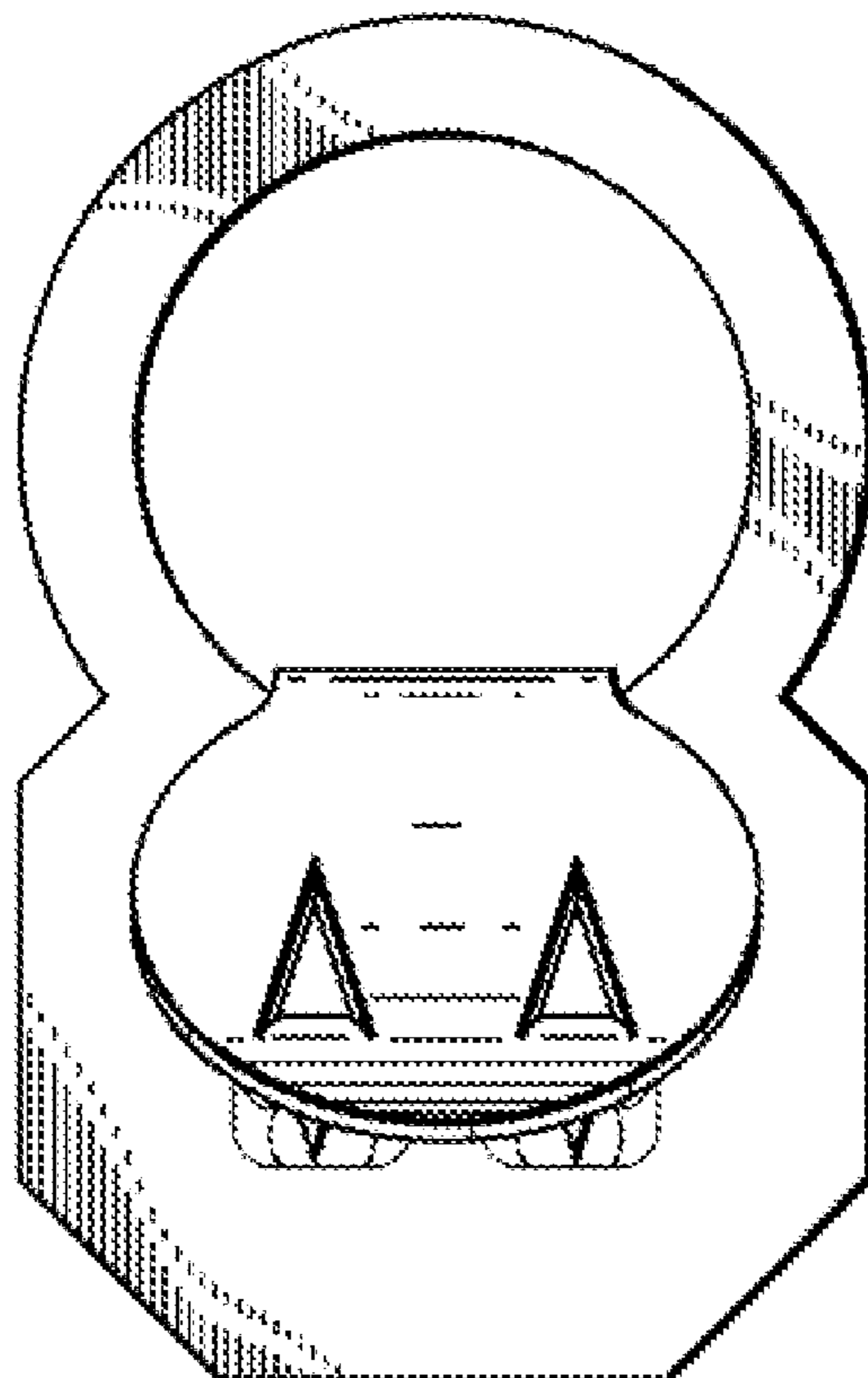

FIG. 1

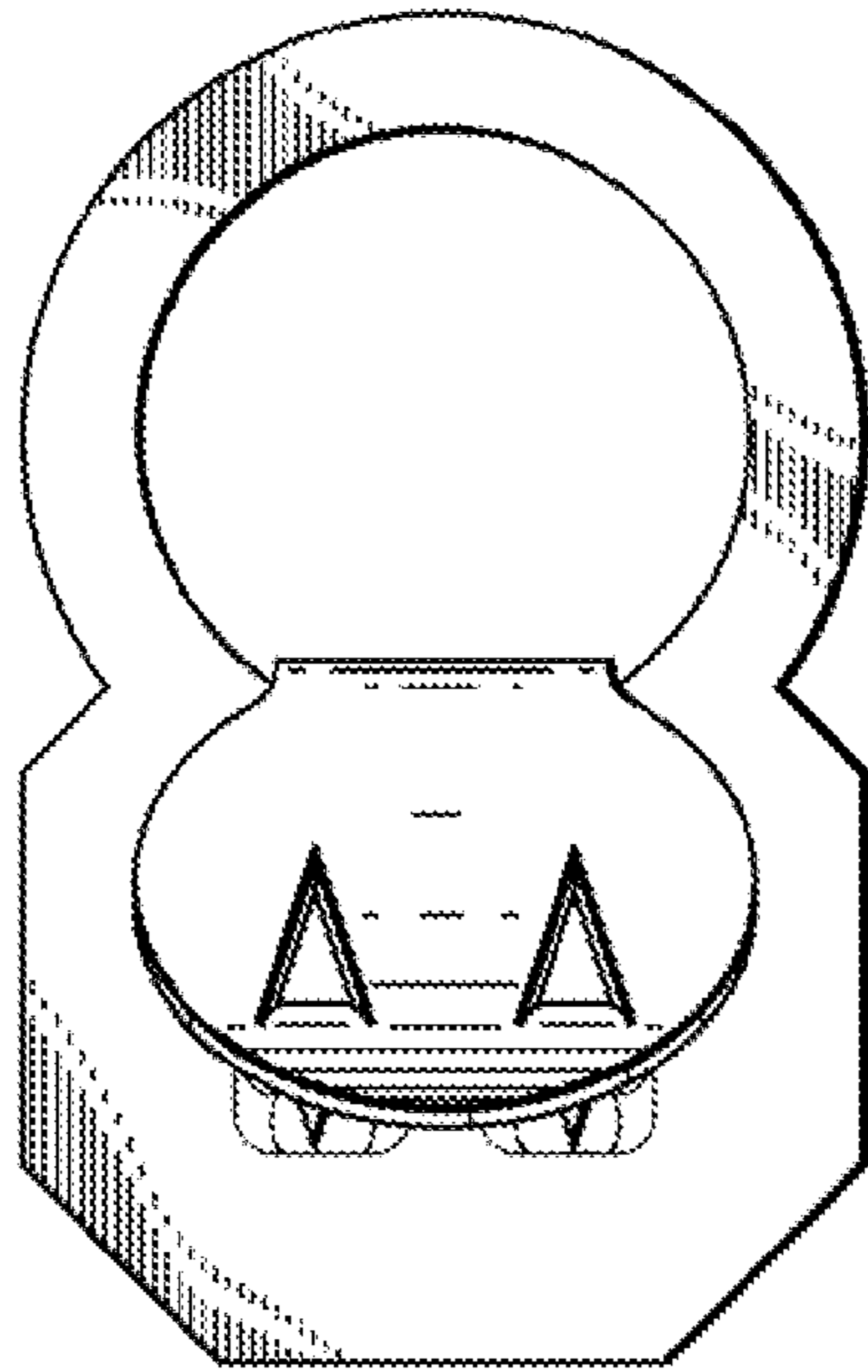

FIG. 2

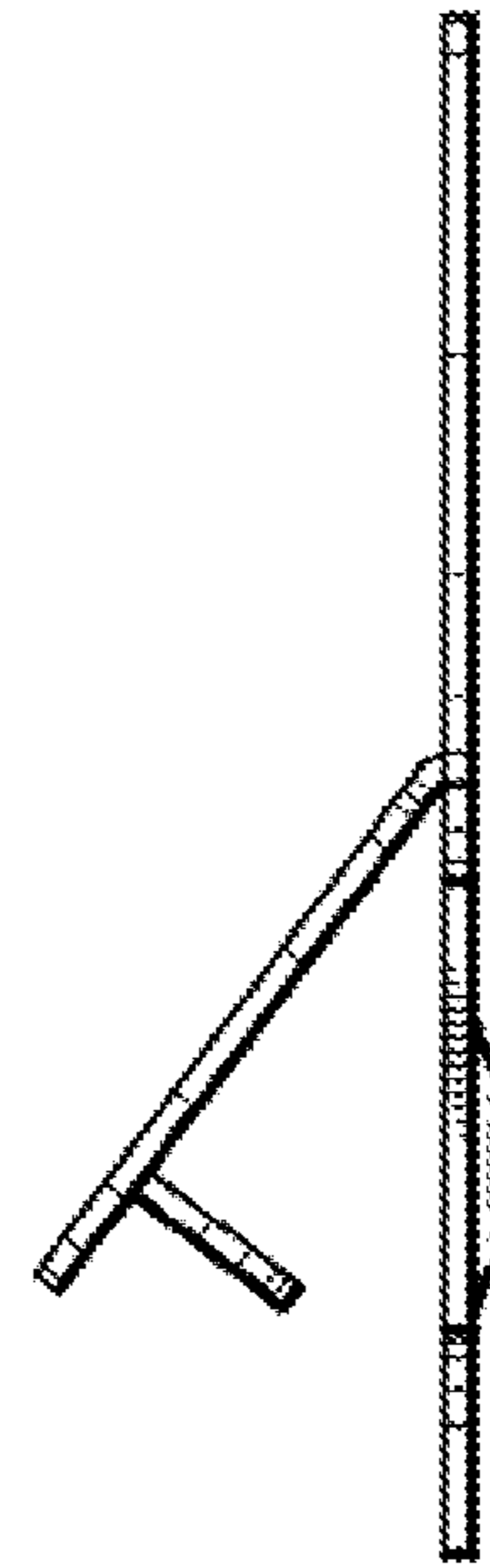

FIG. 3

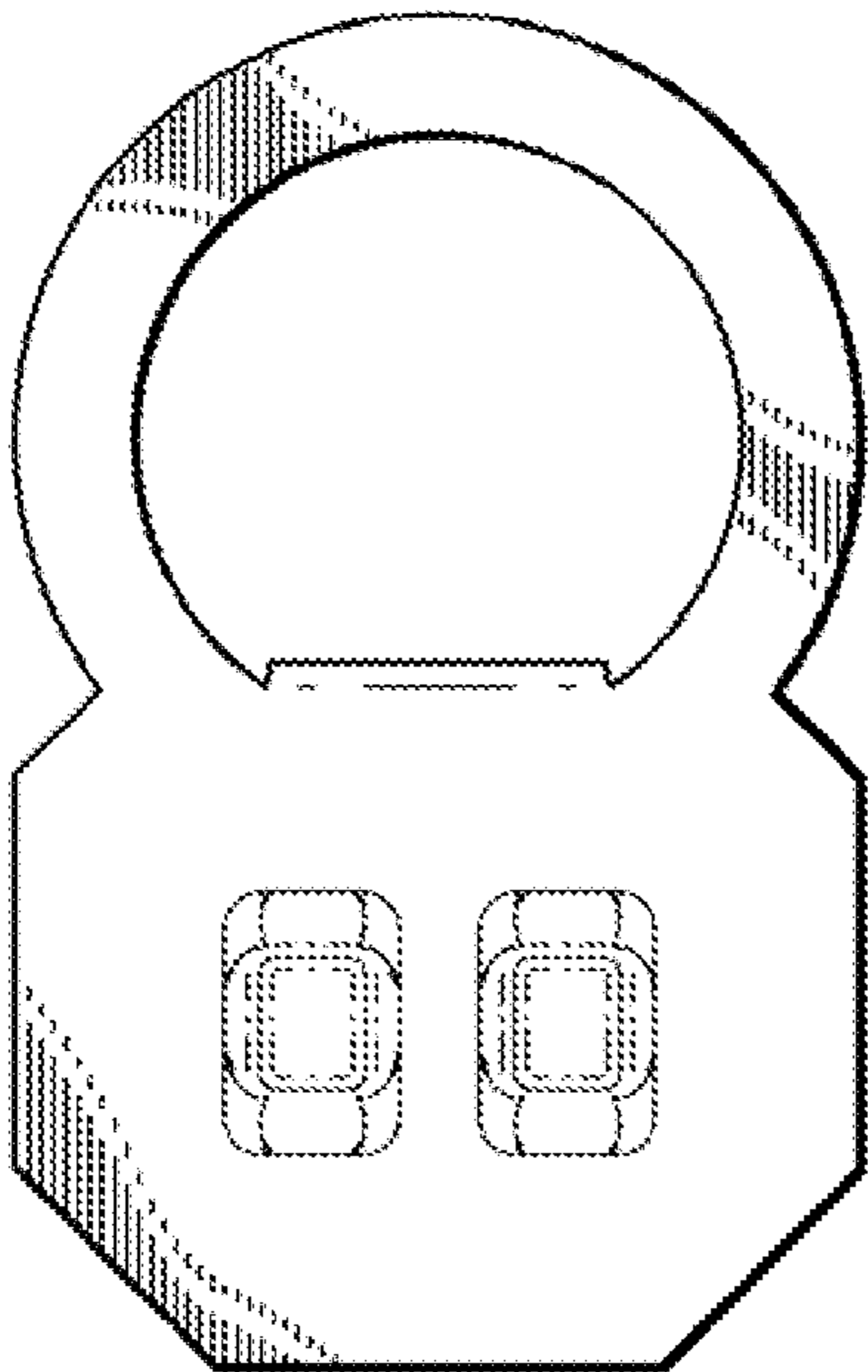

FIG. 4

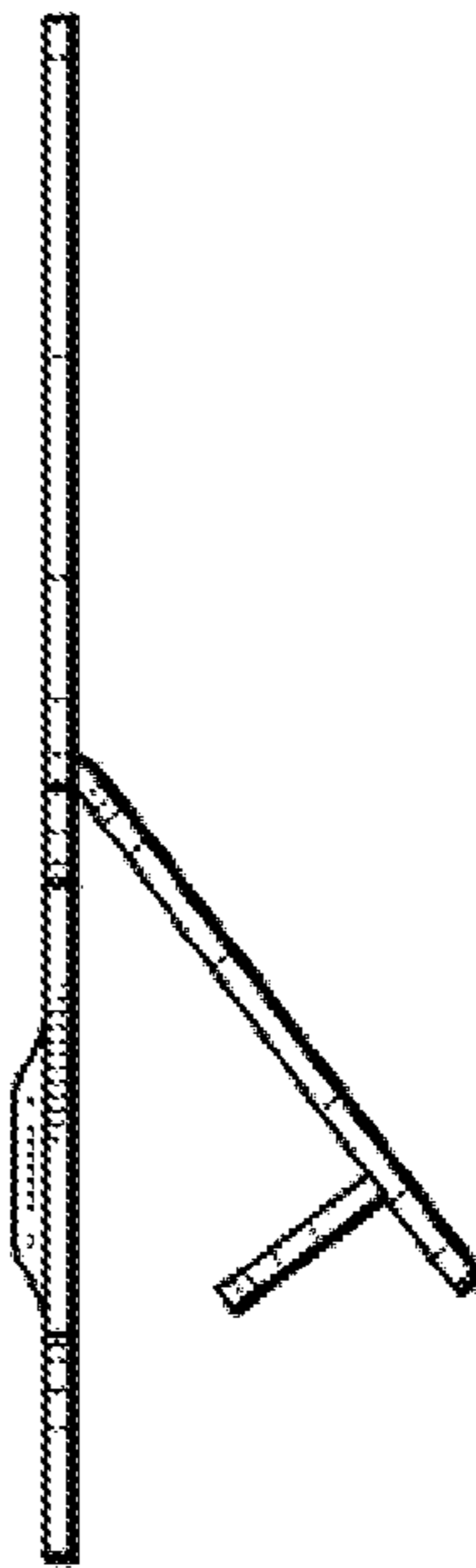

FIG. 5

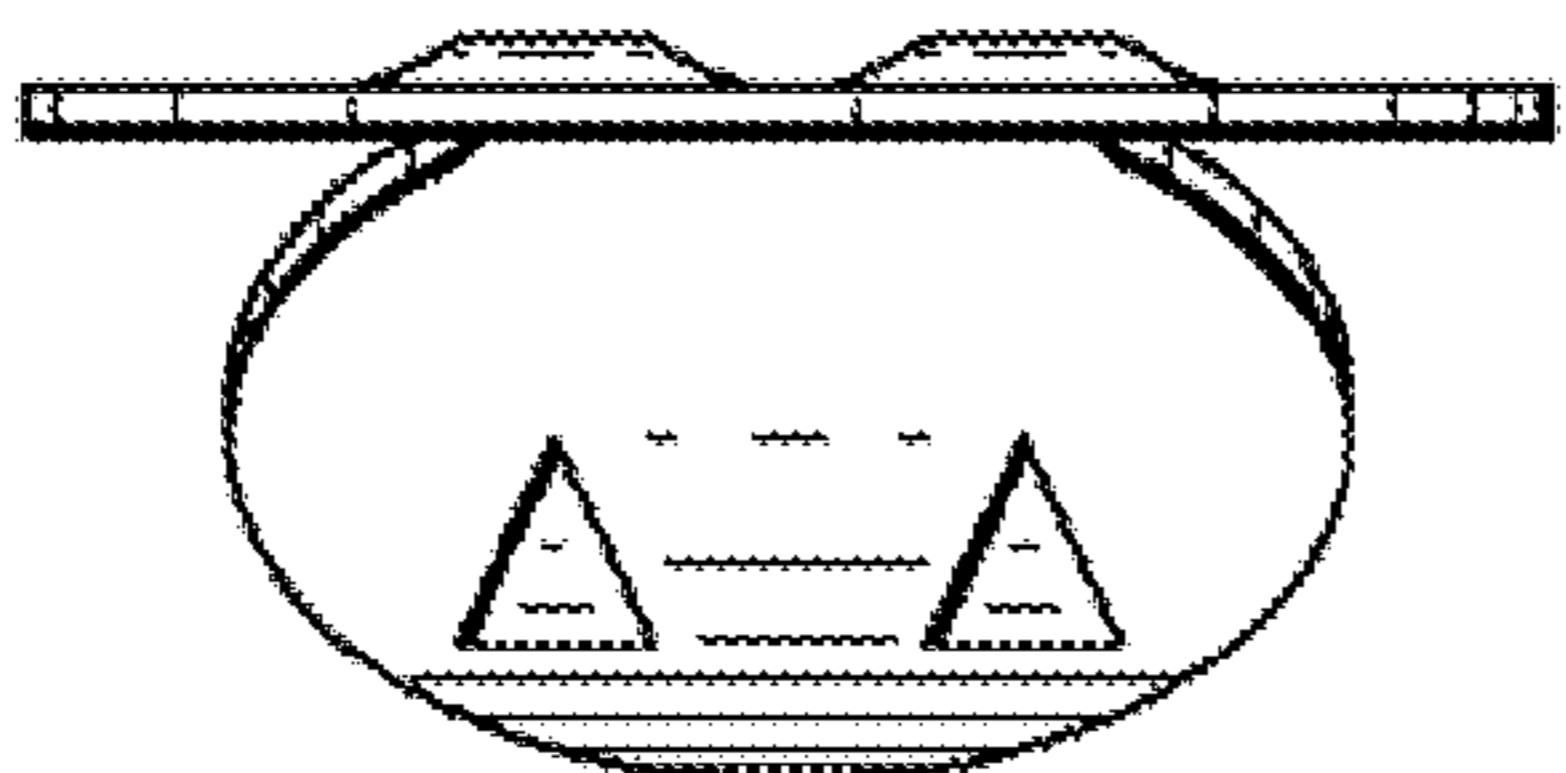

FIG. 6

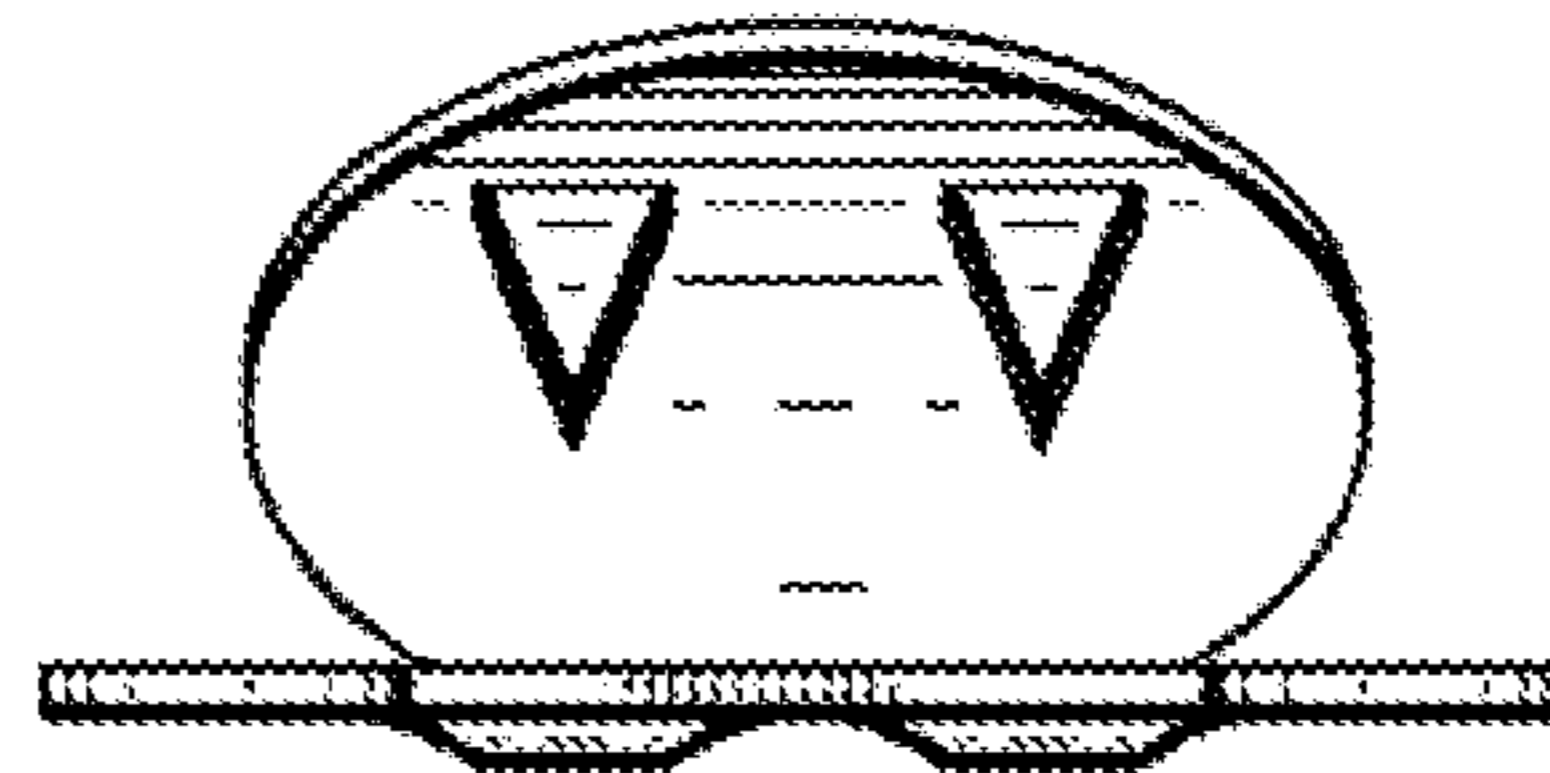

FIG. 8

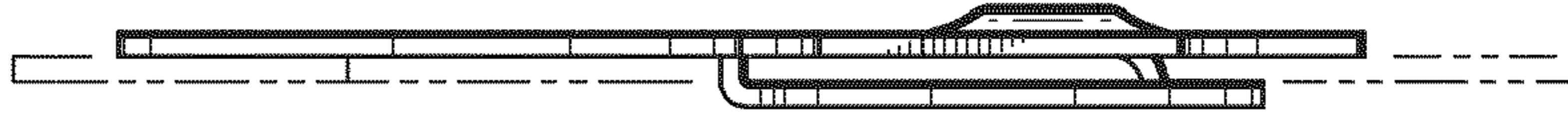

FIG. 7

