



US00D585894S

(12) **United States Design Patent**
Cho et al.

(10) **Patent No.:** **US D585,894 S**
(45) **Date of Patent:** **** Feb. 3, 2009**

(54) **MONITOR**

(75) Inventors: **Jin Seok Cho**, Seoul (KR); **Jung Yeon Hwang**, Seoul (KR); **Hyun Tae Ahn**, Seoul (KR)

(73) Assignee: **LG Electronics Inc.**, Seoul (KR)

(**) Term: **14 Years**

(21) Appl. No.: **29/300,017**

(22) Filed: **Feb. 8, 2008**

(30) **Foreign Application Priority Data**

Aug. 13, 2007 (KR) 30-2007-0034695

(51) **LOC (9) Cl.** **14-02**

(52) **U.S. Cl.** **D14/374**

(58) **Field of Classification Search** D14/371-376,
D14/125-129, 336, 341, 132; 248/917-924,
248/121, 278.1; 341/12; 345/104, 156, 173,
345/174, 901-905; 348/180, 184, 325, 739,
348/837; 361/680-686; D18/12.3; 349/1,
349/2, 11, 58

See application file for complete search history.

(56) **References Cited**

U.S. PATENT DOCUMENTS

D416,875 S * 11/1999 Chuo et al. D14/375

6,229,584	B1 *	5/2001	Chuo et al.	349/58
6,381,125	B1 *	4/2002	Mizoguchi et al.	361/682
6,807,051	B2 *	10/2004	Takahashi	361/681
D522,509	S *	6/2006	Park et al.	D14/375
D556,755	S *	12/2007	Lee et al.	D14/375
2002/0020792	A1 *	2/2002	Lee	248/278.1
2005/0041379	A1 *	2/2005	Jang	361/681
2006/0076463	A1 *	4/2006	Drew	248/121

* cited by examiner

Primary Examiner—Freda S Nunn

(74) *Attorney, Agent, or Firm*—Morgan Lewis & Bockius LLP

(57) **CLAIM**

The ornamental design for a monitor, as shown and described.

DESCRIPTION

FIG. 1 is a front, right perspective of the monitor showing my new design;

FIG. 2 is a front view thereof;

FIG. 3 is a rear view thereof;

FIG. 4 is a left side view thereof;

FIG. 5 is a right side view thereof;

FIG. 6 is a top plan view thereof; and,

FIG. 7 is a bottom plan view thereof.

1 Claim, 5 Drawing Sheets

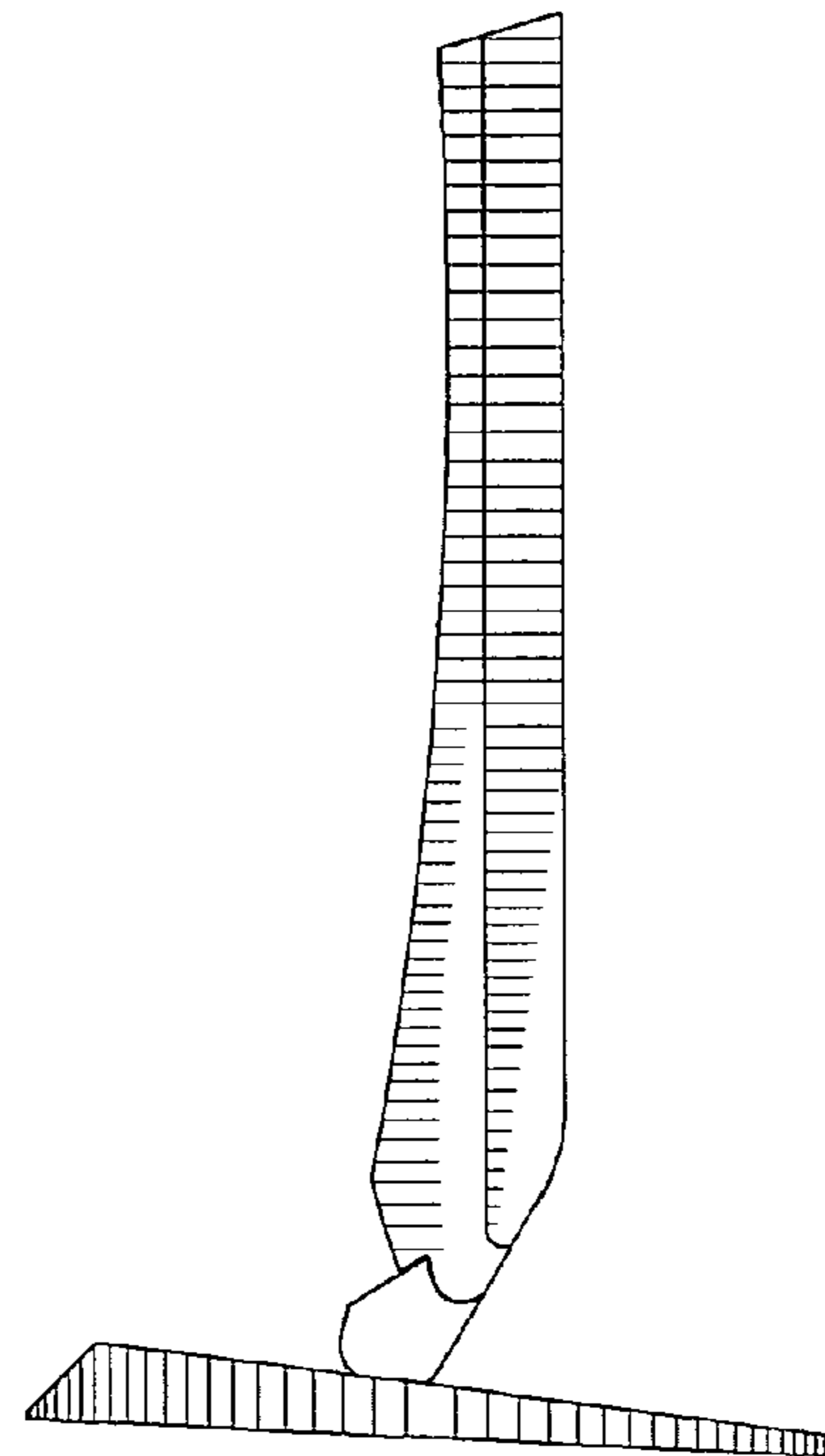
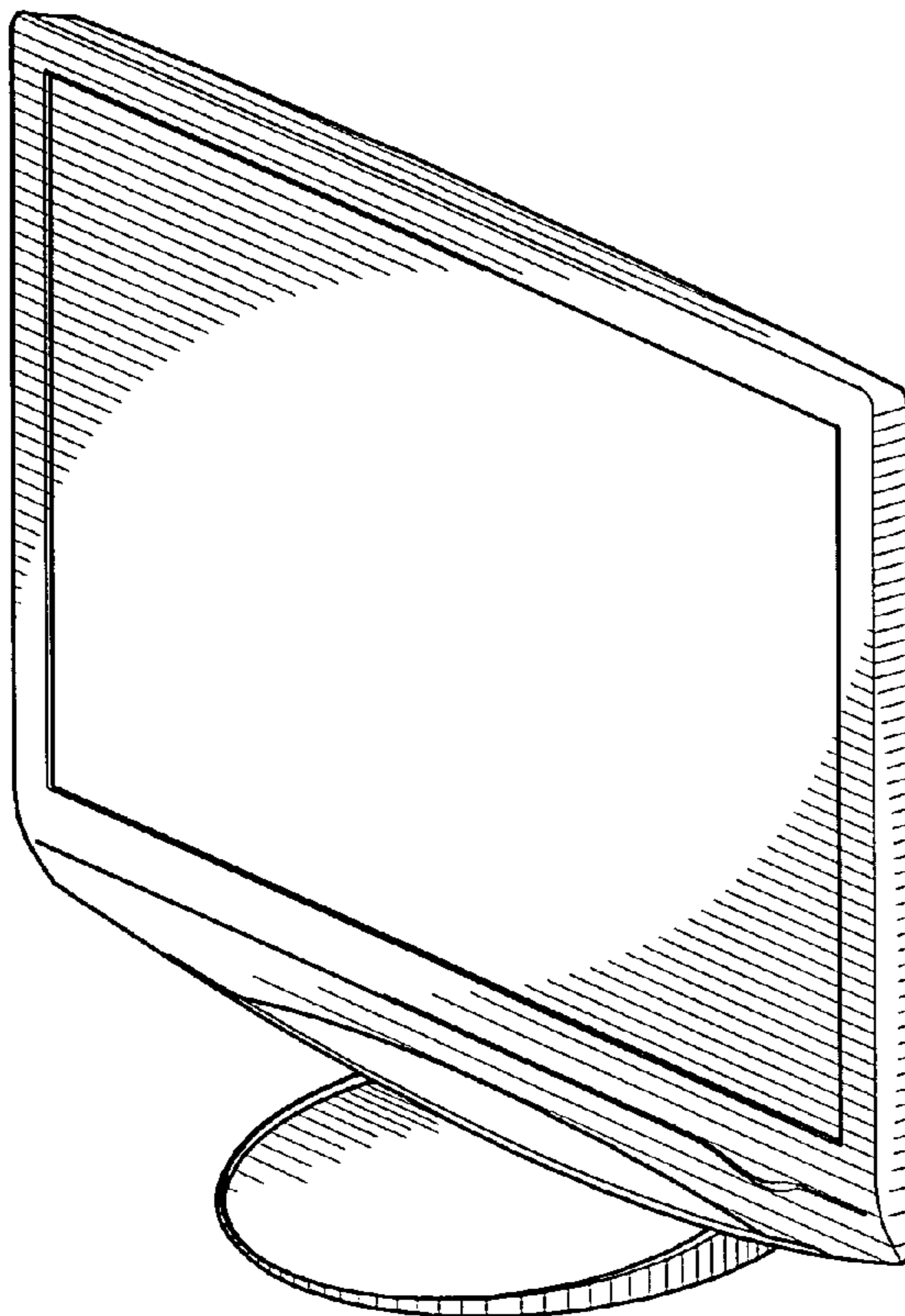

Fig.1

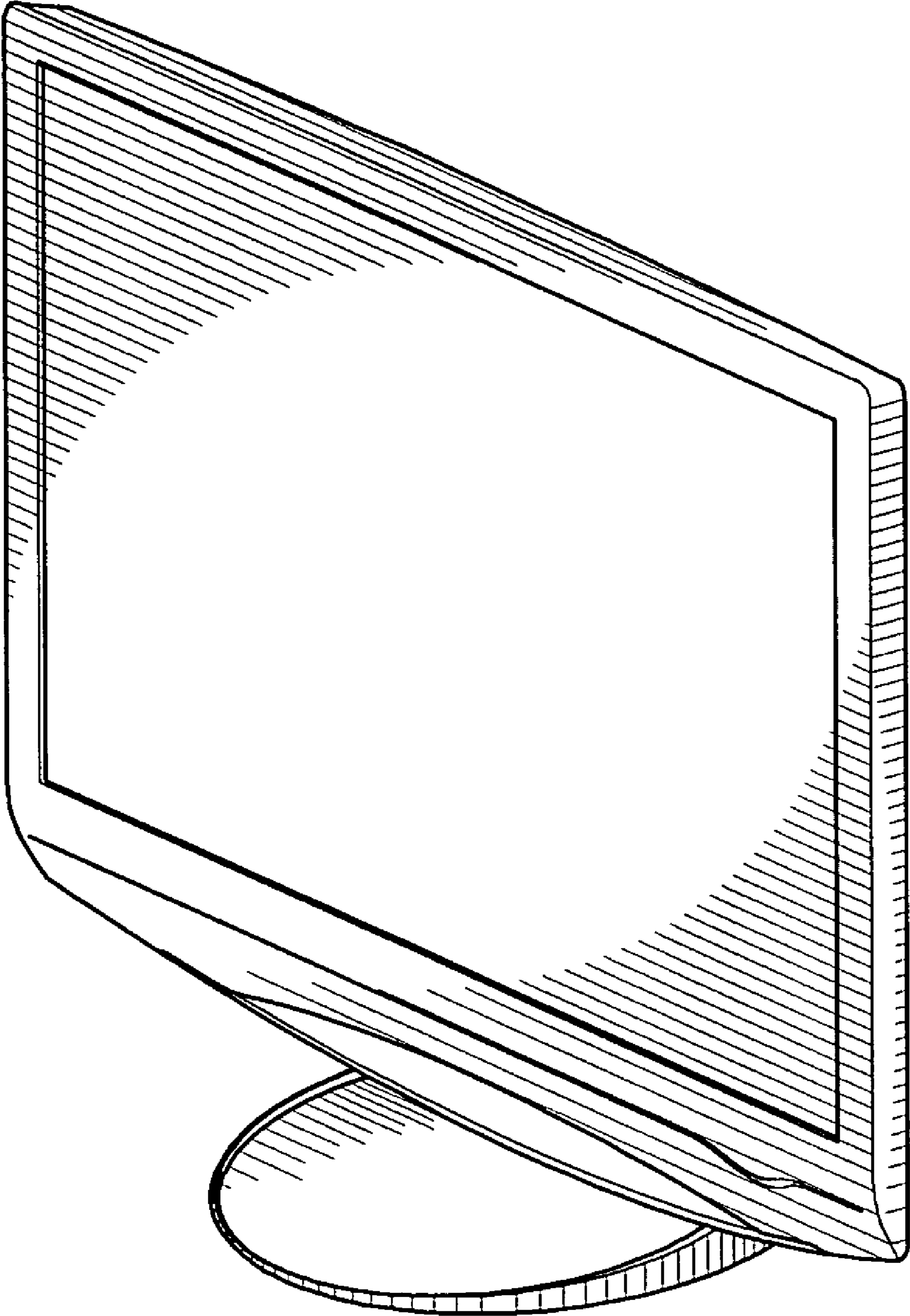

Fig.2

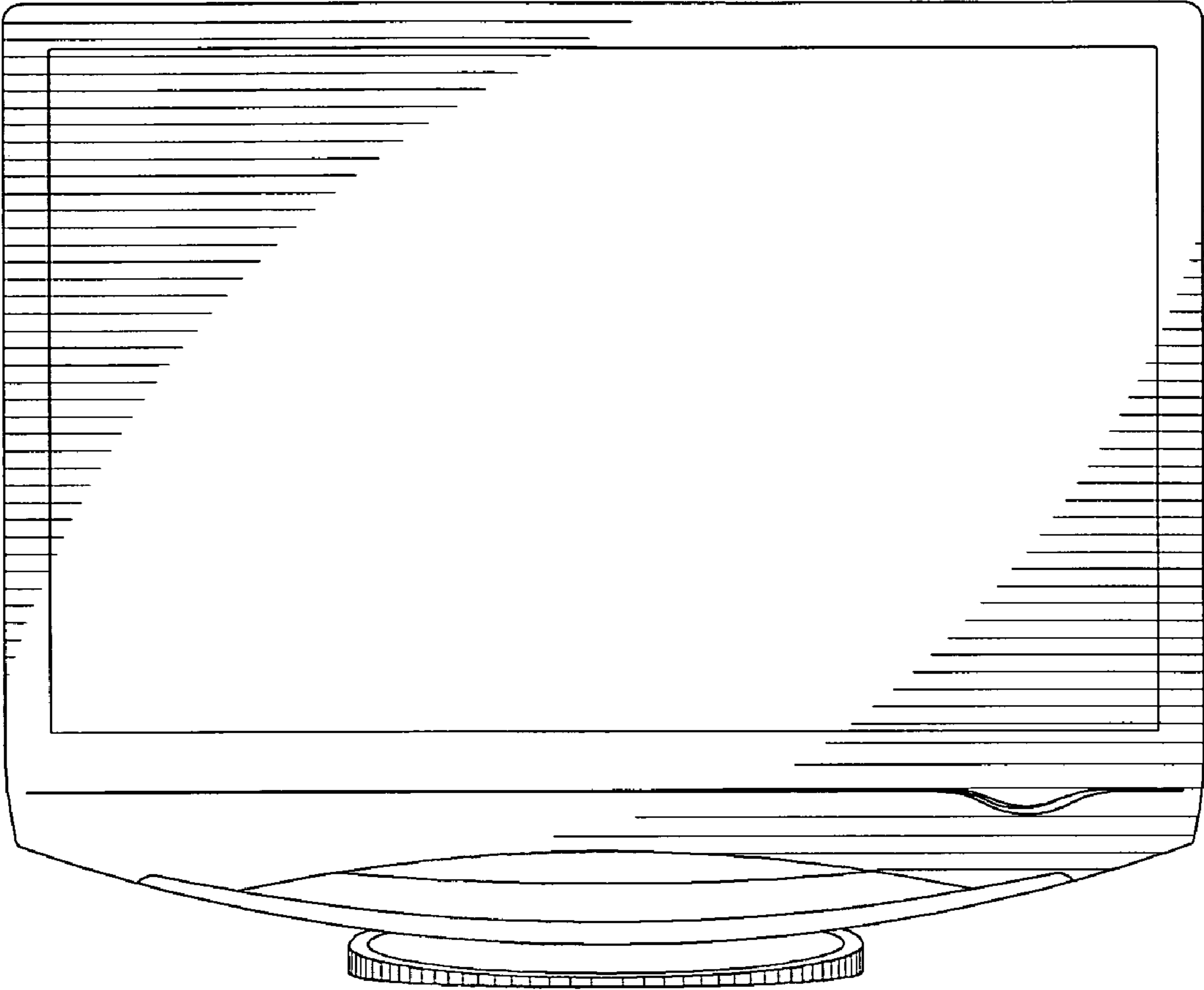

Fig.3

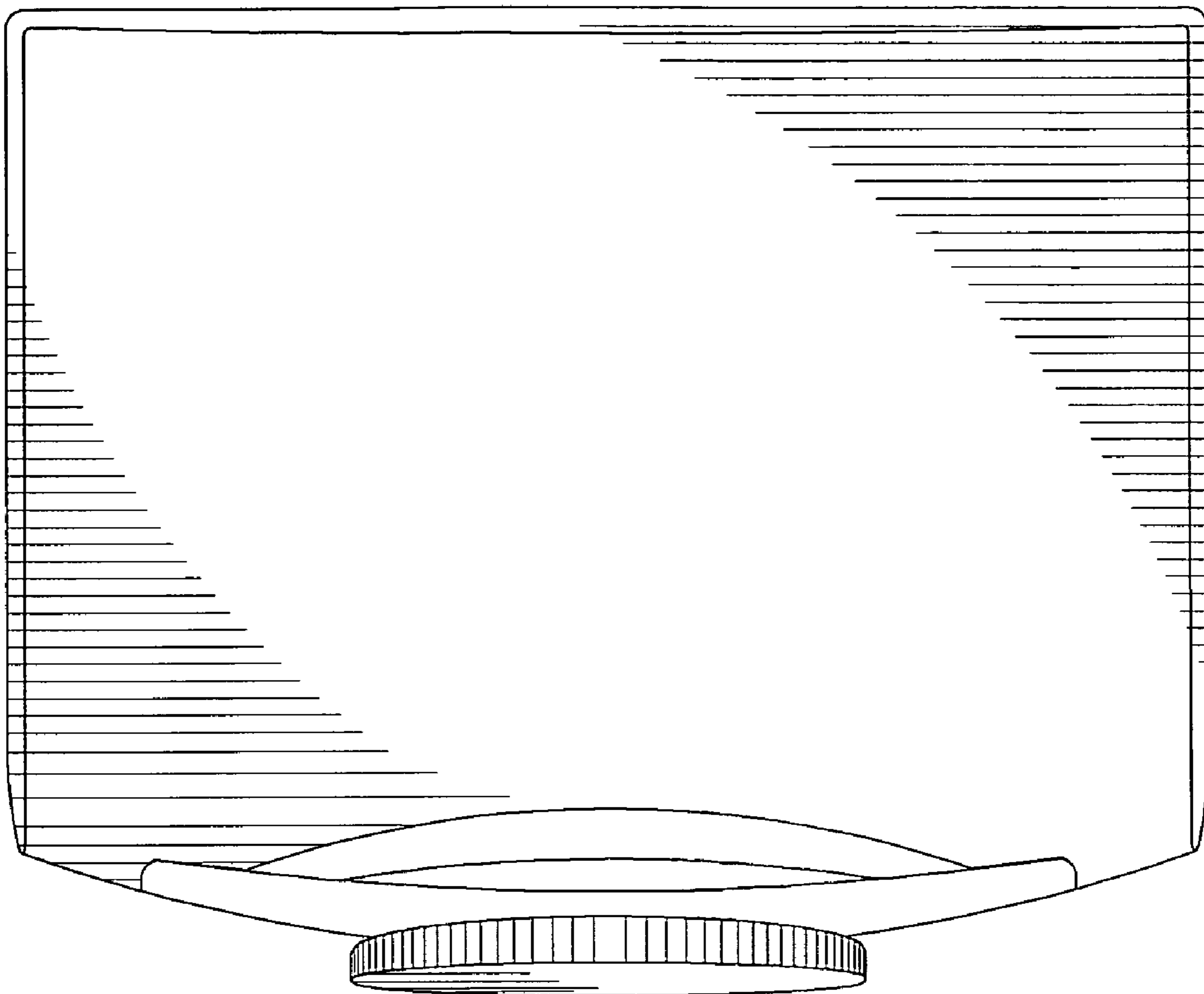

Fig.4

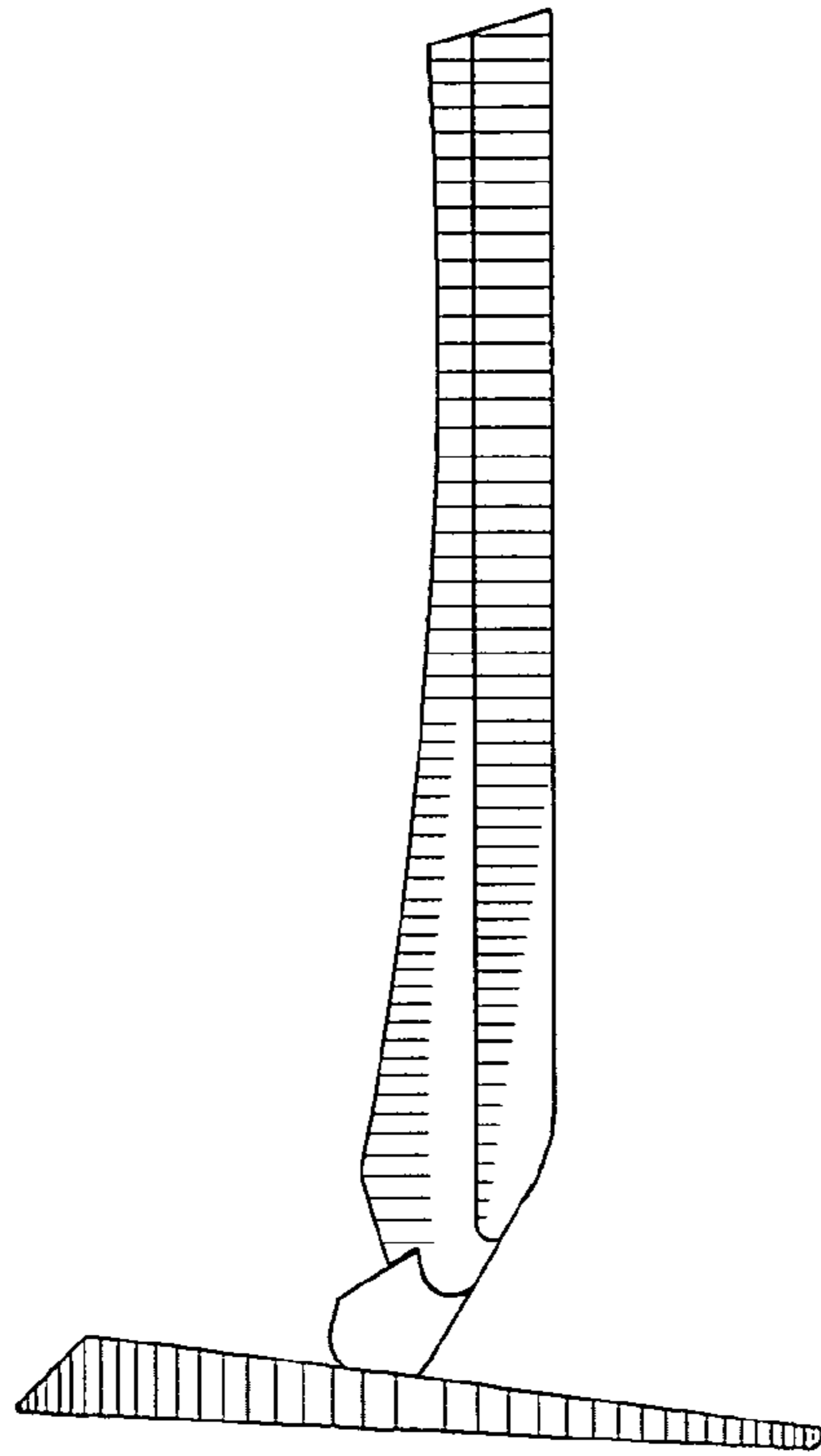

Fig.5

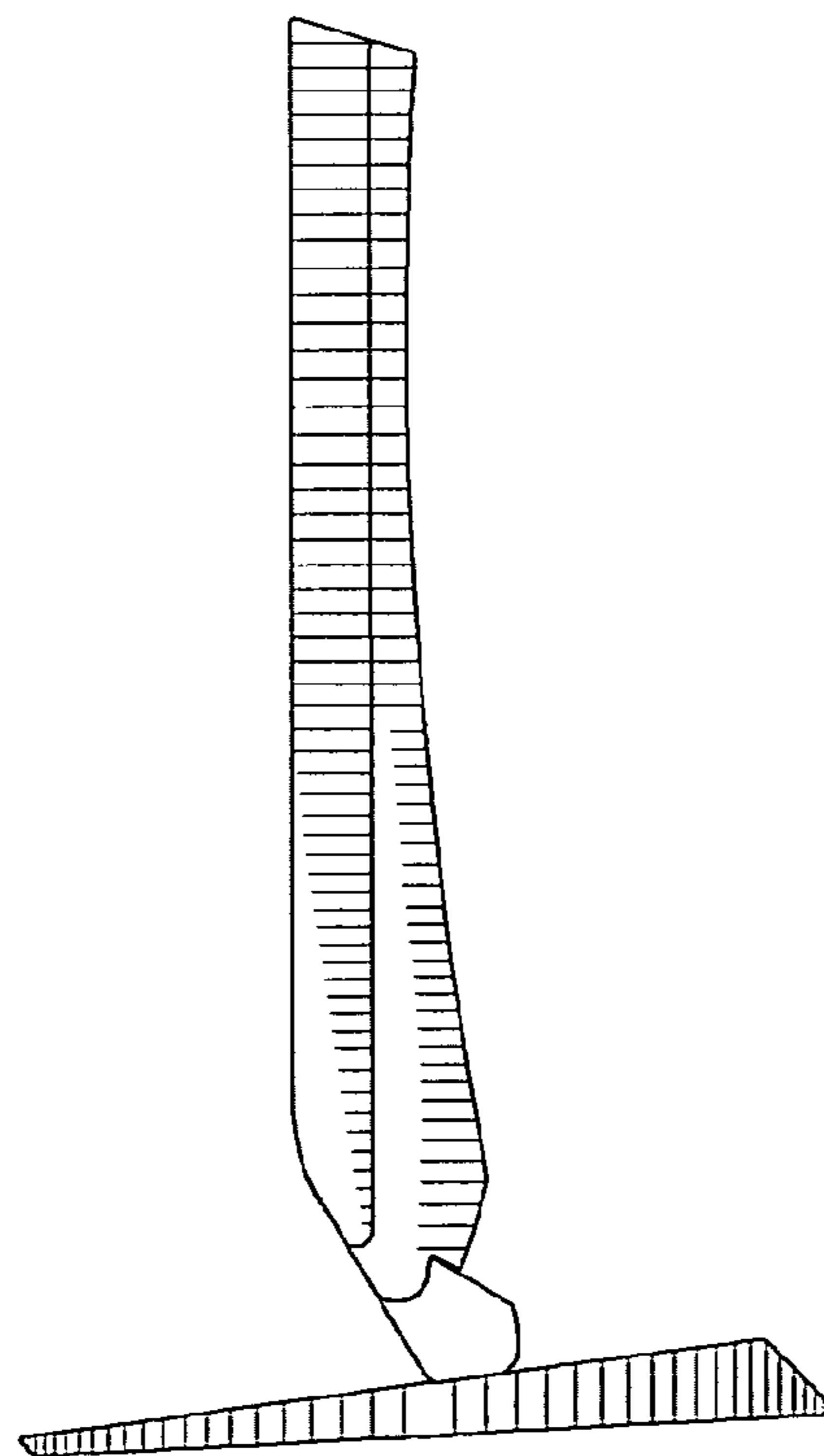

Fig.6

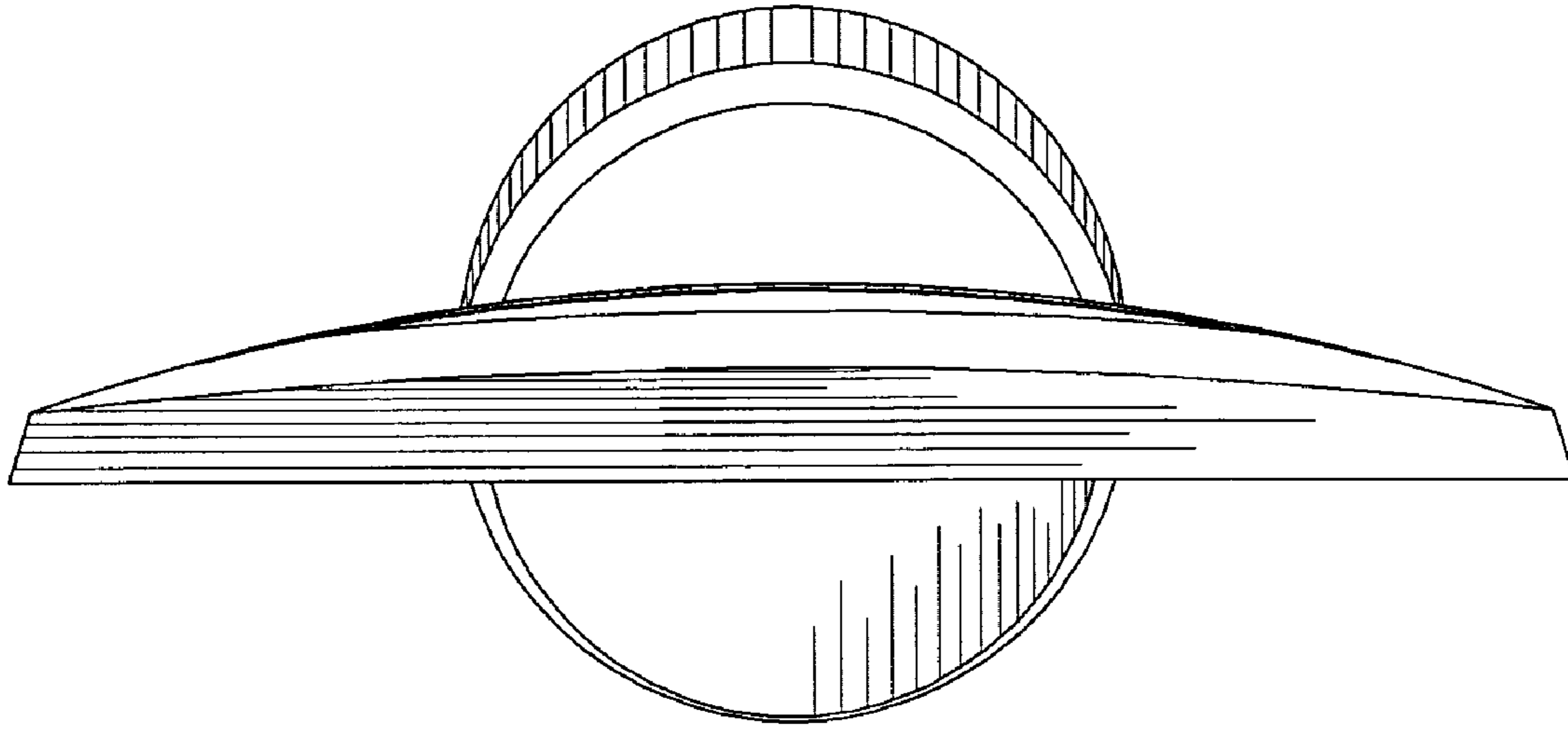

Fig.7

