



US00D585861S

(12) **United States Design Patent**  
**Kim et al.**

(10) **Patent No.:** **US D585,861 S**  
(45) **Date of Patent:** **\*\* Feb. 3, 2009**

(54) **CELLULAR PHONE**

(75) Inventors: **Young-Se Kim**, Palo Alto, CA (US);  
**Young-Ju Yeo**, Seoul (KR);  
**Chang-Hwan Hwang**, Goyang (KR)

(73) Assignee: **Samsung Electronics Co., Ltd.**,  
Suwon-Si (KR)

(\*\*) Term: **14 Years**

(21) Appl. No.: **29/269,313**

(22) Filed: **Nov. 29, 2006**

(30) **Foreign Application Priority Data**

Jun. 5, 2006 (KR) ..... 30-2006-0020863

(51) **LOC (9) Cl.** ..... **14-03**

(52) **U.S. Cl.** ..... **D14/138 AB**

(58) **Field of Classification Search** ..... D14/138,  
D14/496, 341-347; 455/575.3, 575.1; D21/517  
See application file for complete search history.

(56) **References Cited**

**U.S. PATENT DOCUMENTS**

D507,787 S *	7/2005	Ahn et al. ....	D14/138
D508,036 S *	8/2005	Wada .....	D14/138
7,110,797 B2 *	9/2006	Soejima .....	455/575.1
D540,768 S *	4/2007	Cho et al. ....	D14/138
D540,790 S *	4/2007	Kim et al. ....	D14/345
D541,248 S *	4/2007	Lee et al. ....	D14/138
D543,169 S *	5/2007	Kim et al. ....	D14/138
7,212,846 B1 *	5/2007	Chan .....	455/575.3
D546,795 S *	7/2007	Kim et al. ....	D14/138
D548,212 S *	8/2007	Lee .....	D14/138
D549,680 S *	8/2007	Lee et al. ....	D14/138
D551,642 S *	9/2007	Kim et al. ....	D14/138
D552,057 S *	10/2007	Kim .....	D14/138
D558,172 S *	12/2007	Kim et al. ....	D14/138
D559,817 S *	1/2008	Minamide et al. ....	D14/138
D560,189 S *	1/2008	Kim et al. ....	D14/138
D562,790 S *	2/2008	Hering et al. ....	D14/138
7,336,979 B2 *	2/2008	Soejima .....	455/575.1
D563,344 S *	3/2008	Kim et al. ....	D14/138
D563,924 S *	3/2008	Arnold et al. ....	D14/138
D564,486 S *	3/2008	Miyazaki et al. ....	D14/138
D565,010 S *	3/2008	Baik et al. ....	D14/138

2005/0148375 A1 *	7/2005	DeLine .....	455/575.3
2005/0219067 A1 *	10/2005	Chung .....	341/22
2006/0135222 A1 *	6/2006	Kim .....	455/575.1
2008/0039158 A1 *	2/2008	Park et al. ....	455/575.3

**OTHER PUBLICATIONS**

Samsung SPH-P900 telephone, posted Nov. 8, 2006, [online], [retrieved on Feb. 4, 2007]. Retrieved from Internet , <URL http://www.mobiletechnews.com>.\*

Samsung D700 telephone, announced 3rd quarter 2003, [online], [site visited Apr. 12, 2008]. Available from Internet , 21 URL http://www.gsmarena.com>.\*

(Continued)

*Primary Examiner*—Jeffrey D Asch

(74) *Attorney, Agent, or Firm*—Staas & Halsey LLP

(57) **CLAIM**

The ornamental design for a cellular phone, as shown and described.

**DESCRIPTION**

FIG. 1 is a perspective view of a cellular phone according to our new design;

FIG. 2 is a front elevational view thereof;

FIG. 3 is a rear elevational view thereof;

FIG. 4 is a left side elevational view thereof;

FIG. 5 is a right side elevational view thereof;

FIG. 6 is a top plan view thereof;

FIG. 7 is a bottom plan view thereof; and,

FIG. 8 is a front elevations view of the cellular phone according to our new design in a state in which the cellular phone is opened to be used, and showing the cellular phone with the displaying part rotated to an alternate position.

The broken line shown in FIG. 8, which is immediately adjacent to the claimed surfaces and defines a large unshaded region, represents the bounds of the claimed design; the broken lines form no part of the claimed design.

**1 Claim, 7 Drawing Sheets**

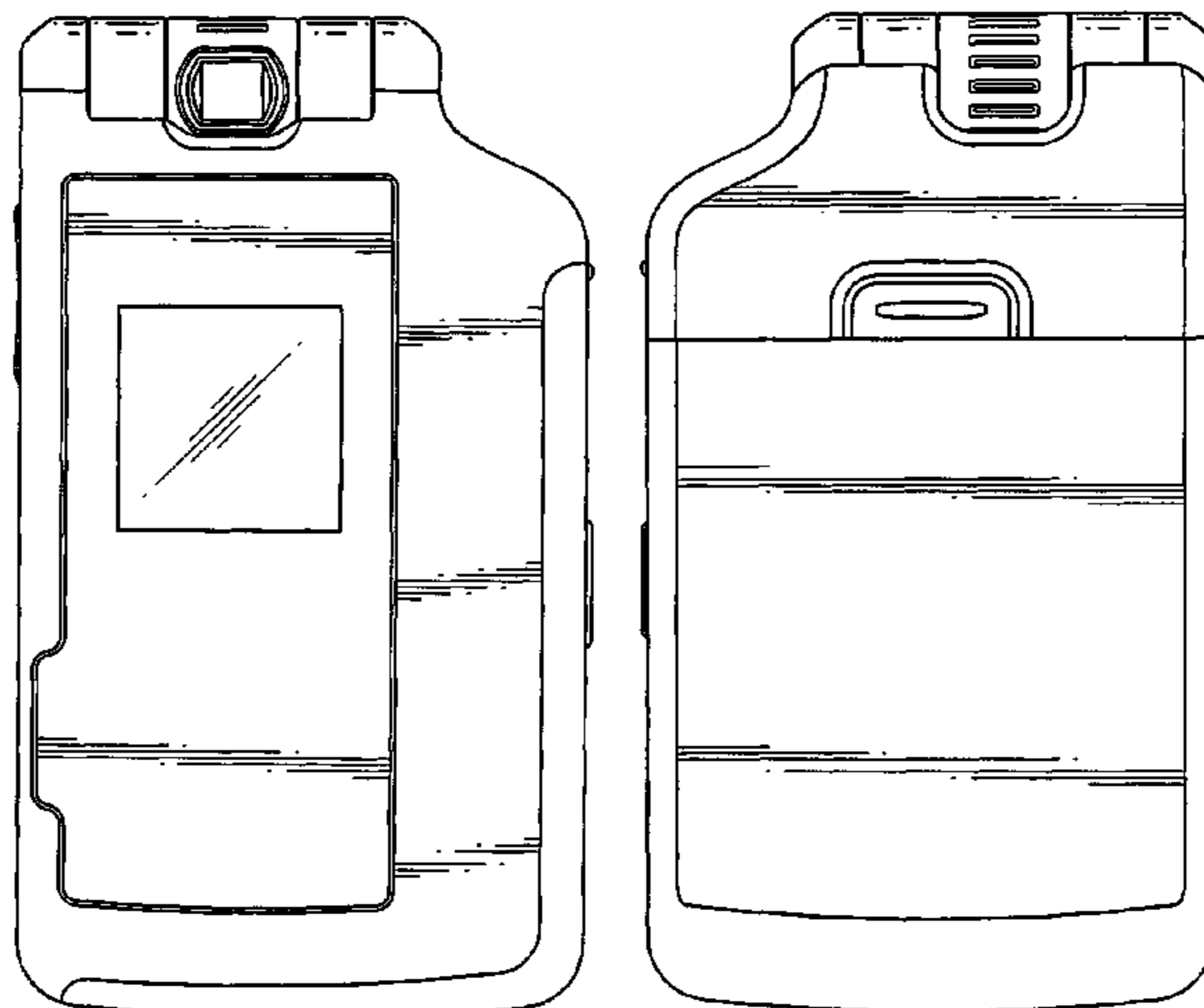

OTHER PUBLICATIONS

Samsung P940 telephone, announced Dec. 2006, [online], [site visited Apr. 12, 2008]. Available from Internet , <URL: <http://www.gsmarena.com>>.\*

Alcatel OT-C652 telephone, announced 1st quarter 2005, [online], [site visited Apr. 12, 2008], Available from Internet ,<URL <http://www.gsmarena.com>>.\*

Pantech PG-3200 telephone, announced 2nd quarter 2005, [online], [site visited Apr. 12, 2008]. Available from Internet , <URL: <http://www.gsmarena.com>>.\*

Sony Ericsson Z800 telephone, announced 1st quarter 2005, [online], [site visited Apr. 12, 2008]. Available from Internet , <URL: <http://www.gsmarena.com>>.\*

\* cited by examiner

FIG.1

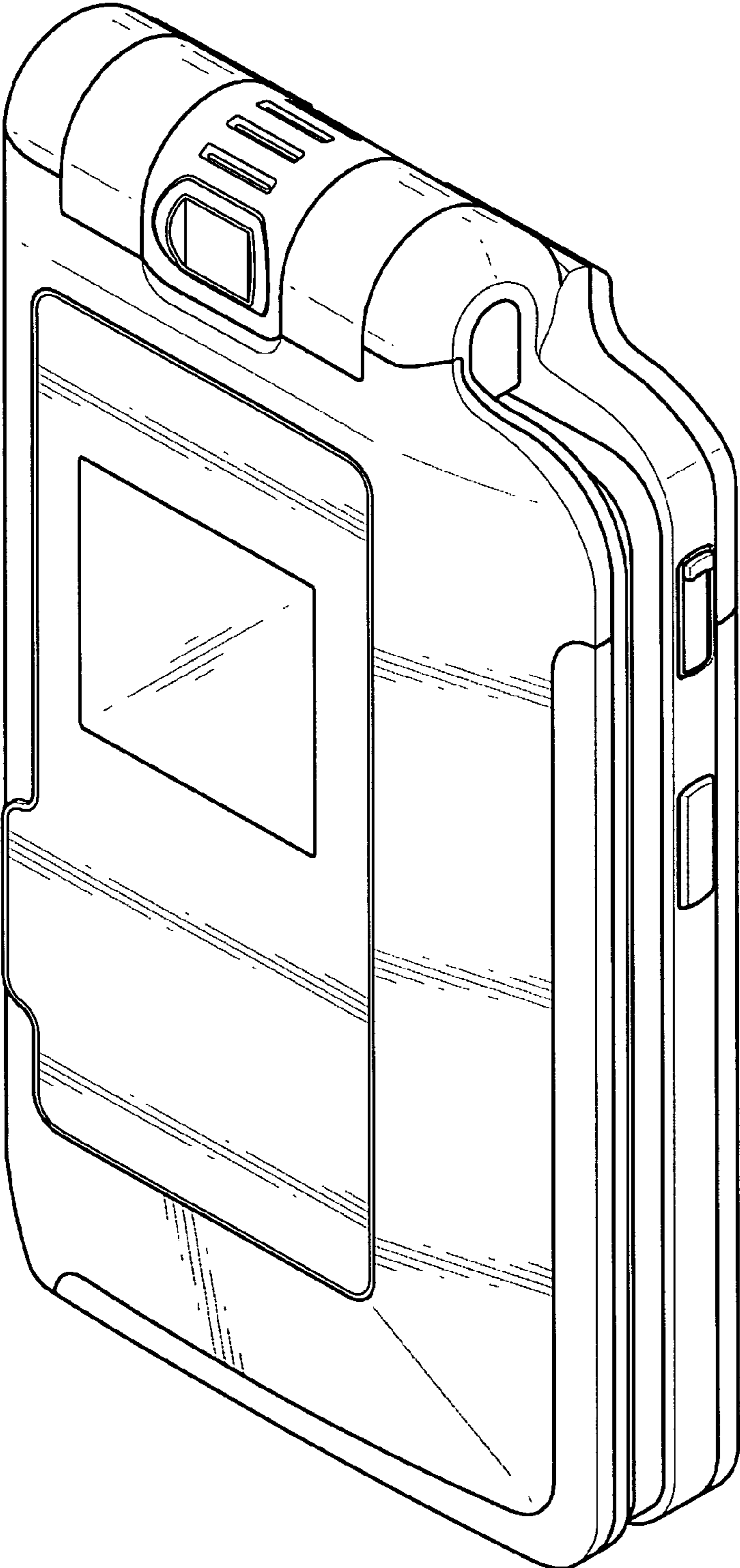

FIG.2

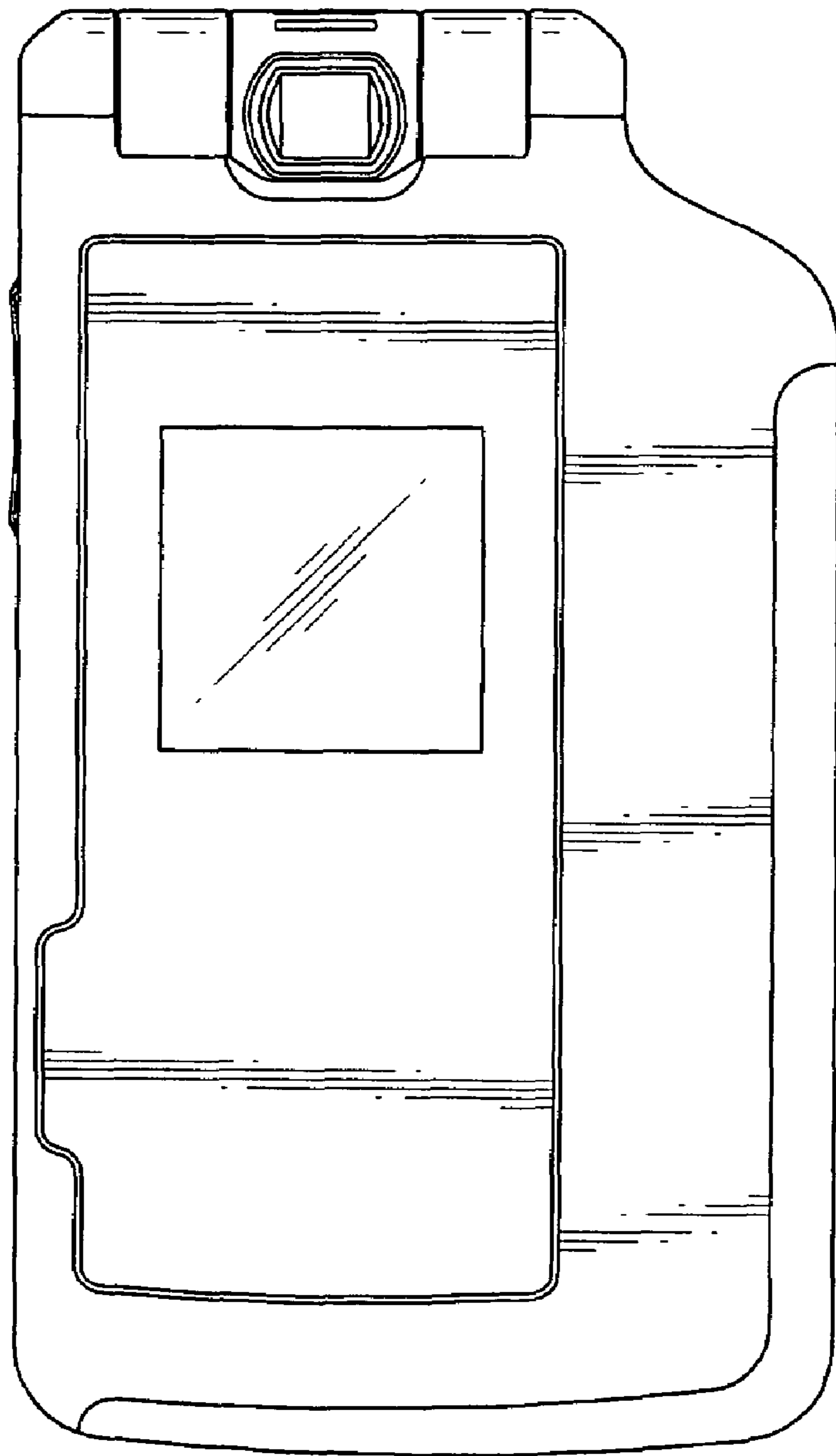

FIG.3

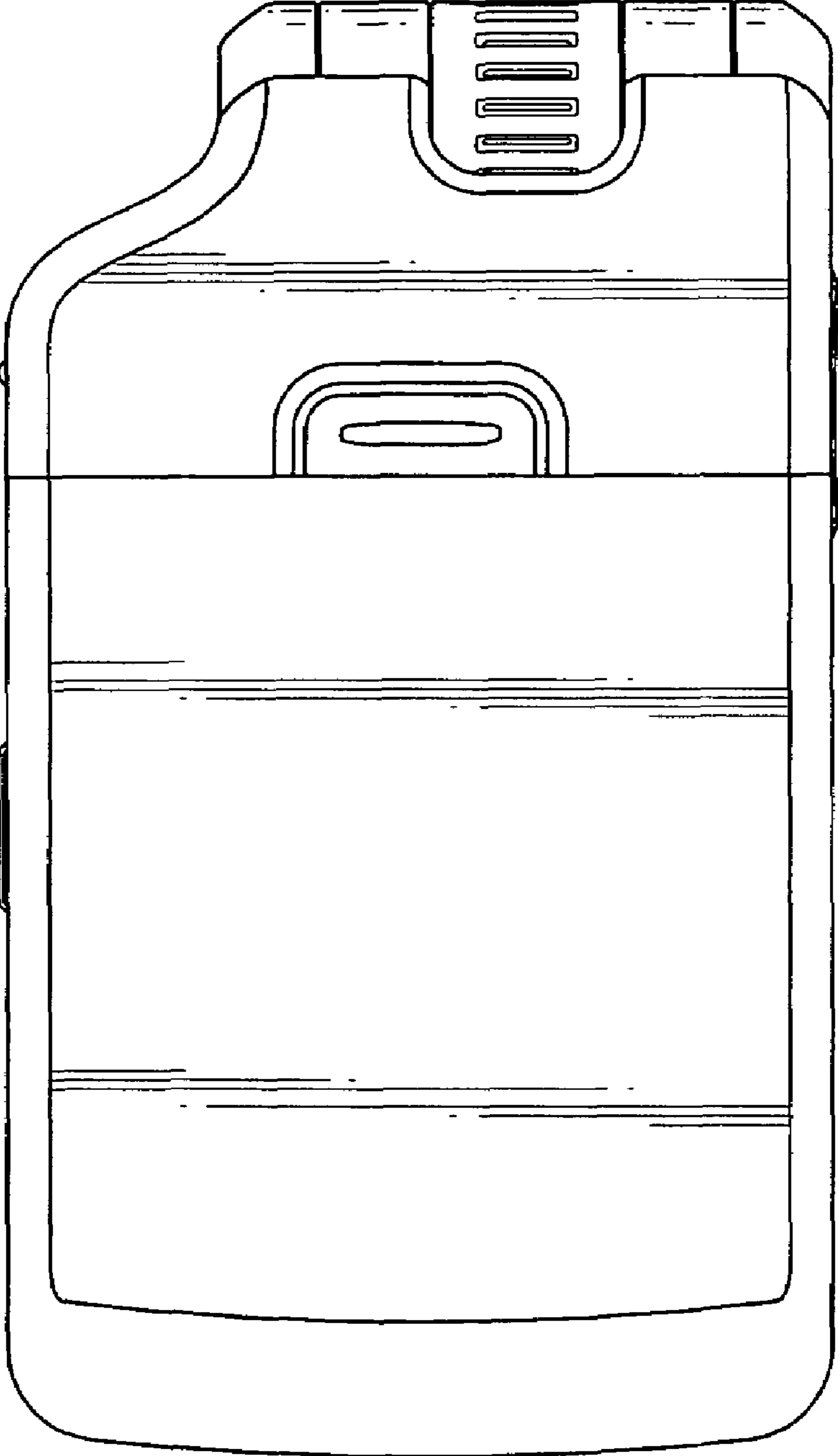

FIG.4

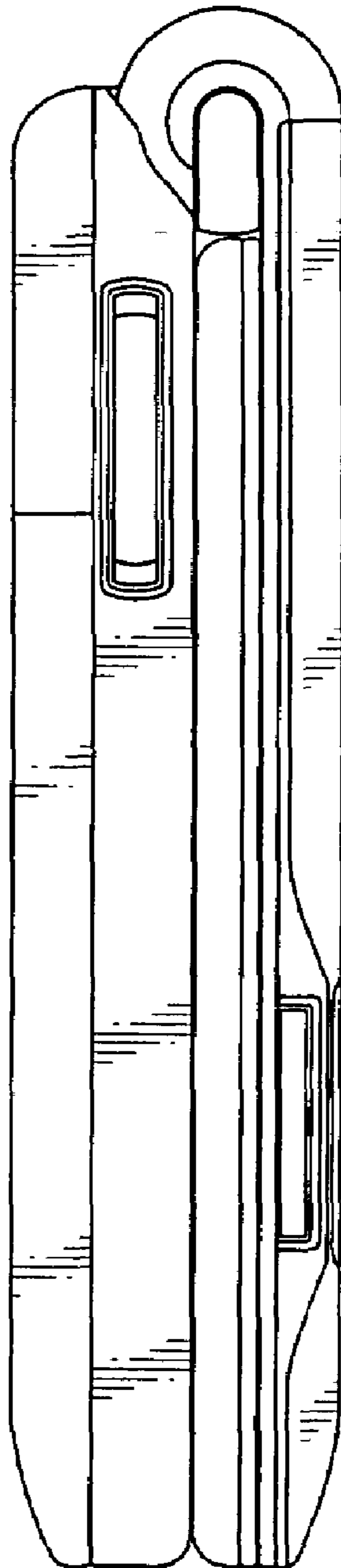

FIG. 5

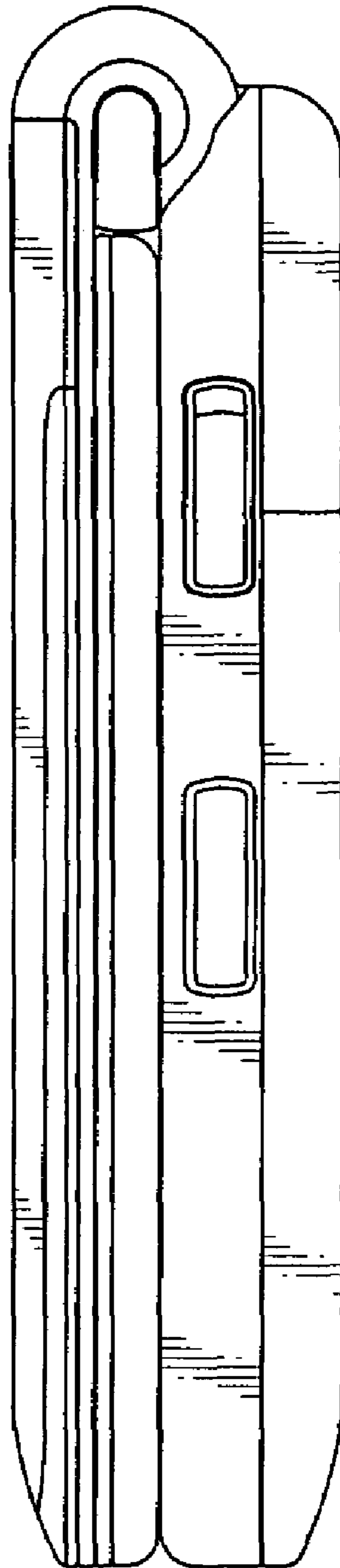



FIG.6



FIG.7

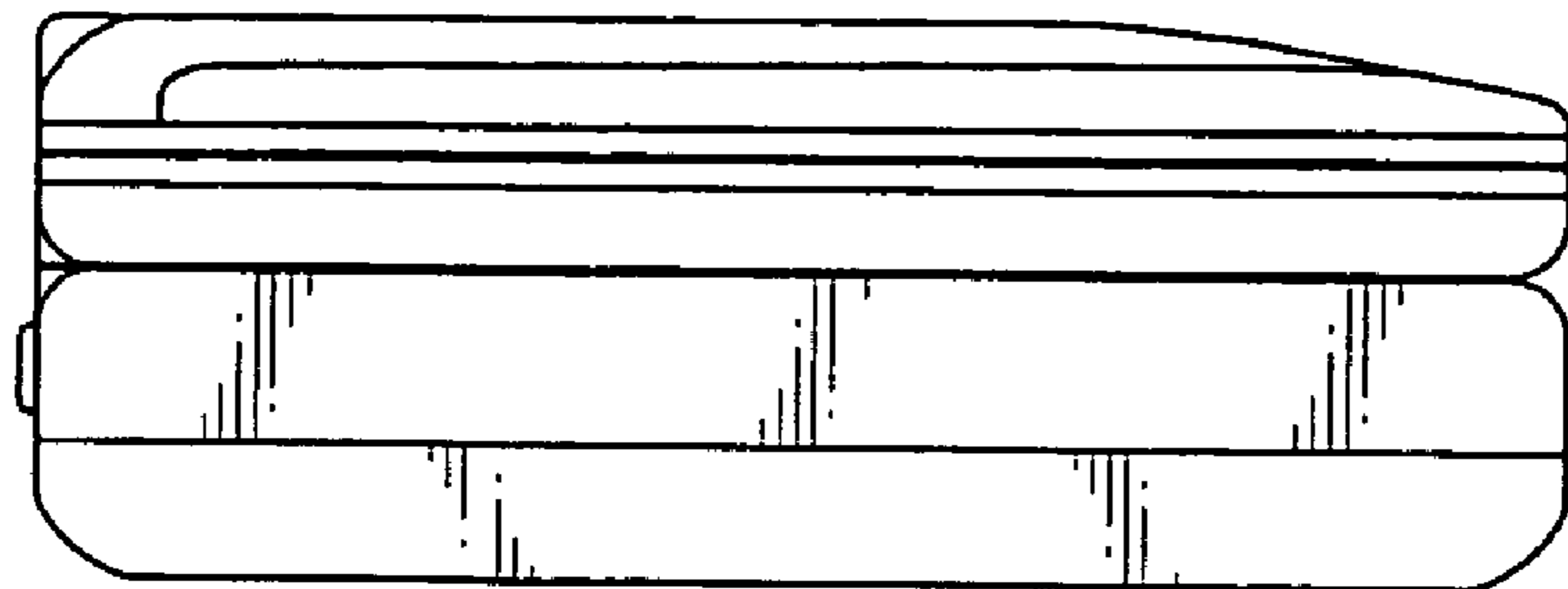



FIG. 8

