



US00D585827S

(12) **United States Design Patent**
Lin et al.

(10) **Patent No.:** **US D585,827 S**
(45) **Date of Patent:** **** Feb. 3, 2009**

(54) **USB CASING**

(75) Inventors: **Chih-Ming Lin**, Taichung (TW);
Chin-Tsai Shih, Taichung Hsien (TW)

(73) Assignee: **Excel Cell Electronic Co., Ltd**,
Taichung (TW)

(**) Term: **14 Years**

(21) Appl. No.: **29/274,562**

(22) Filed: **May 3, 2007**

(30) **Foreign Application Priority Data**

Feb. 6, 2007 (TW) 96301145

(51) **LOC (9) Cl.** **13-03**

(52) **U.S. Cl.** **D13/133; D13/147**

(58) **Field of Classification Search** D13/146-147,
D13/154, 184; 439/79, 108, 378, 607-610,
439/660, 668, 680

See application file for complete search history.

(56) **References Cited**

U.S. PATENT DOCUMENTS

D452,848 S * 1/2002 Shimojyo D13/147

D476,954 S * 7/2003 Nishio et al. D13/147
D480,686 S * 10/2003 Takahashi D13/147
6,659,799 B2 * 12/2003 Yang 439/607

* cited by examiner

Primary Examiner—Daniel D Bui

(74) *Attorney, Agent, or Firm*—Jacobson Holman PLLC

(57) **CLAIM**

The ornamental design for USB casing, as shown and described.

DESCRIPTION

FIG. 1 is a perspective view of a USB casing showing our new design;

FIG. 2 is a front elevational view thereof;

FIG. 3 is a rear elevational view thereof;

FIG. 4 is a left side elevational view thereof;

FIG. 5 is a right side elevational view thereof;

FIG. 6 is a top plan view thereof; and,

FIG. 7 is a bottom plan view thereof.

1 Claim, 7 Drawing Sheets

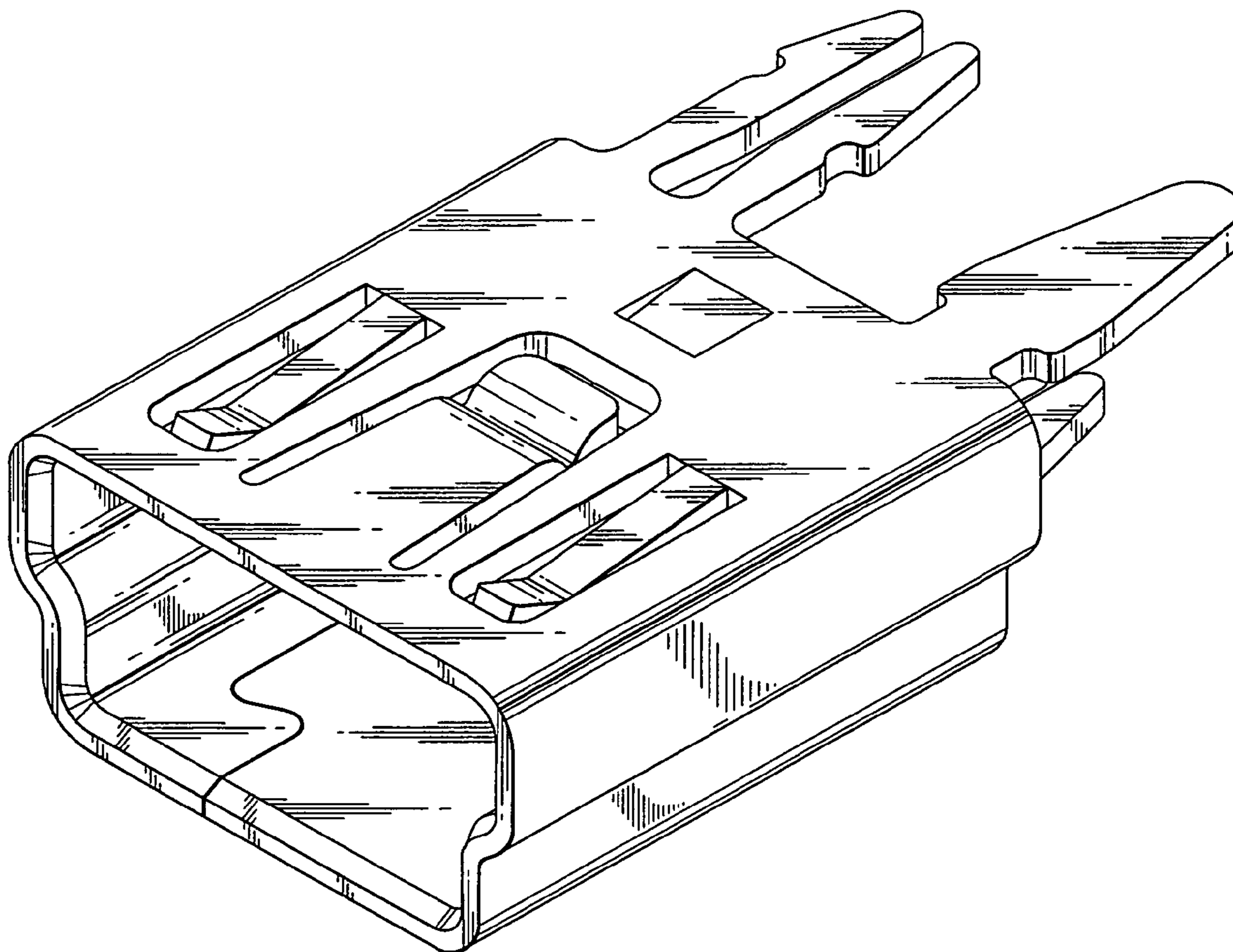

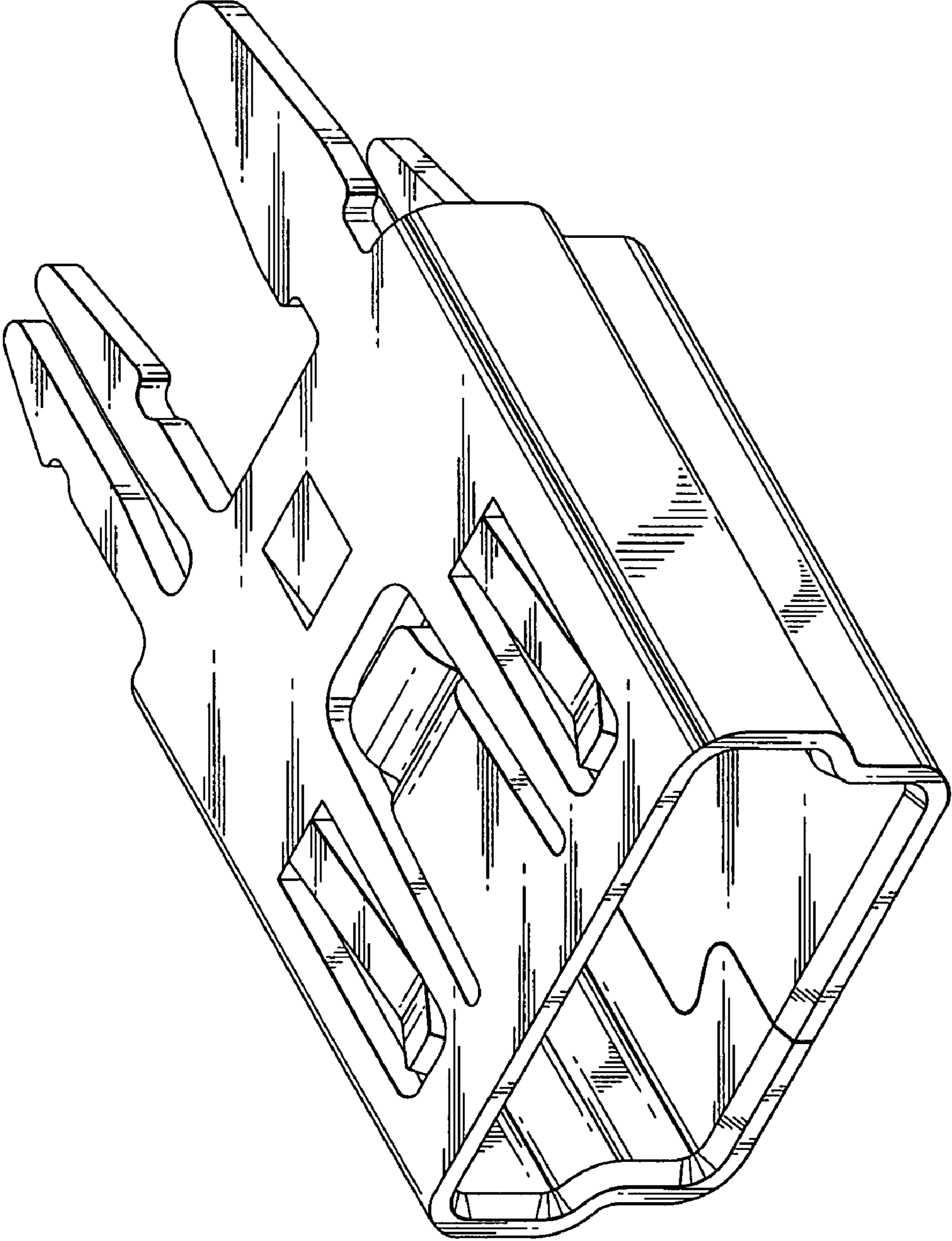

FIG. 1

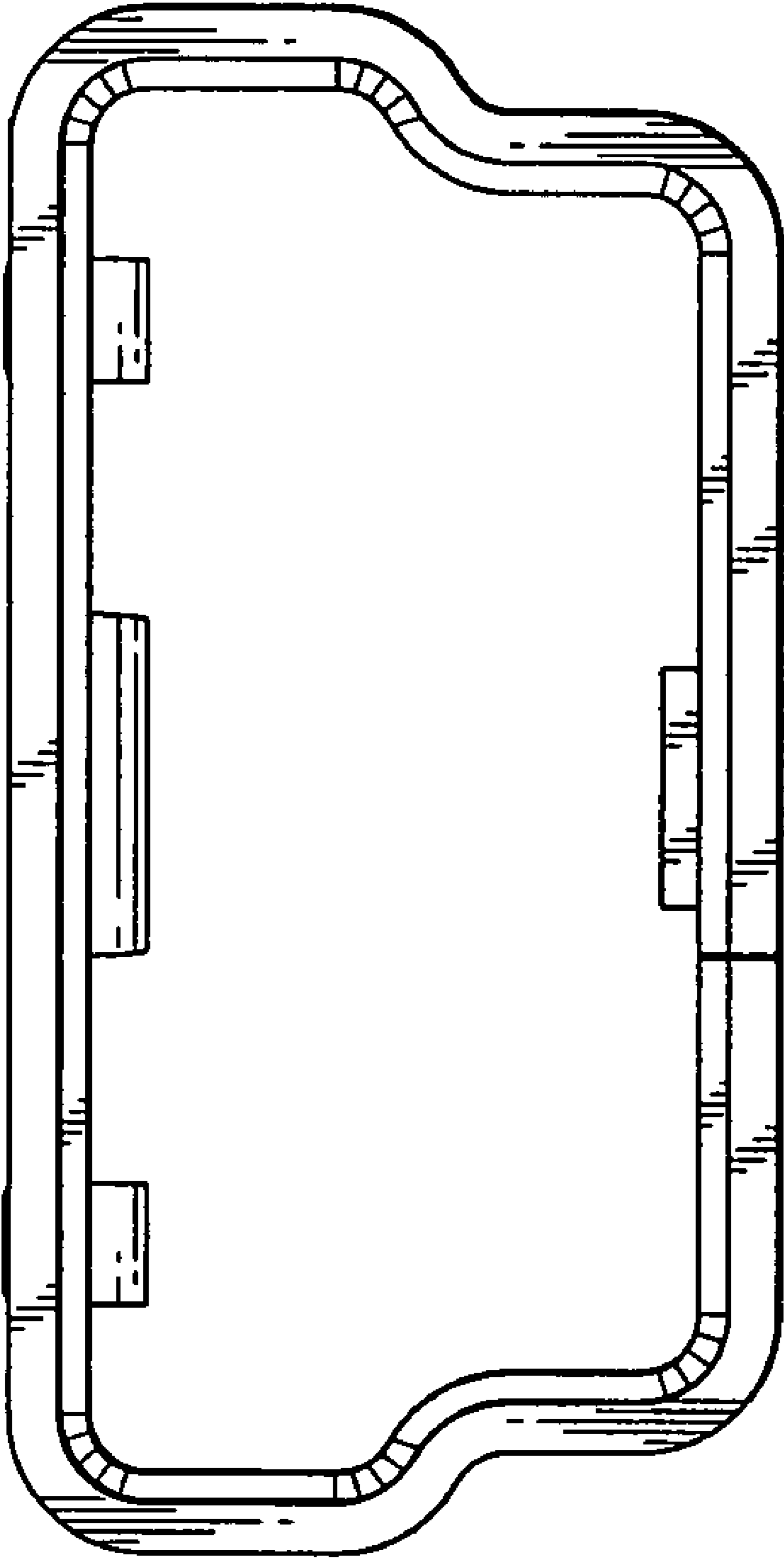

FIG. 2

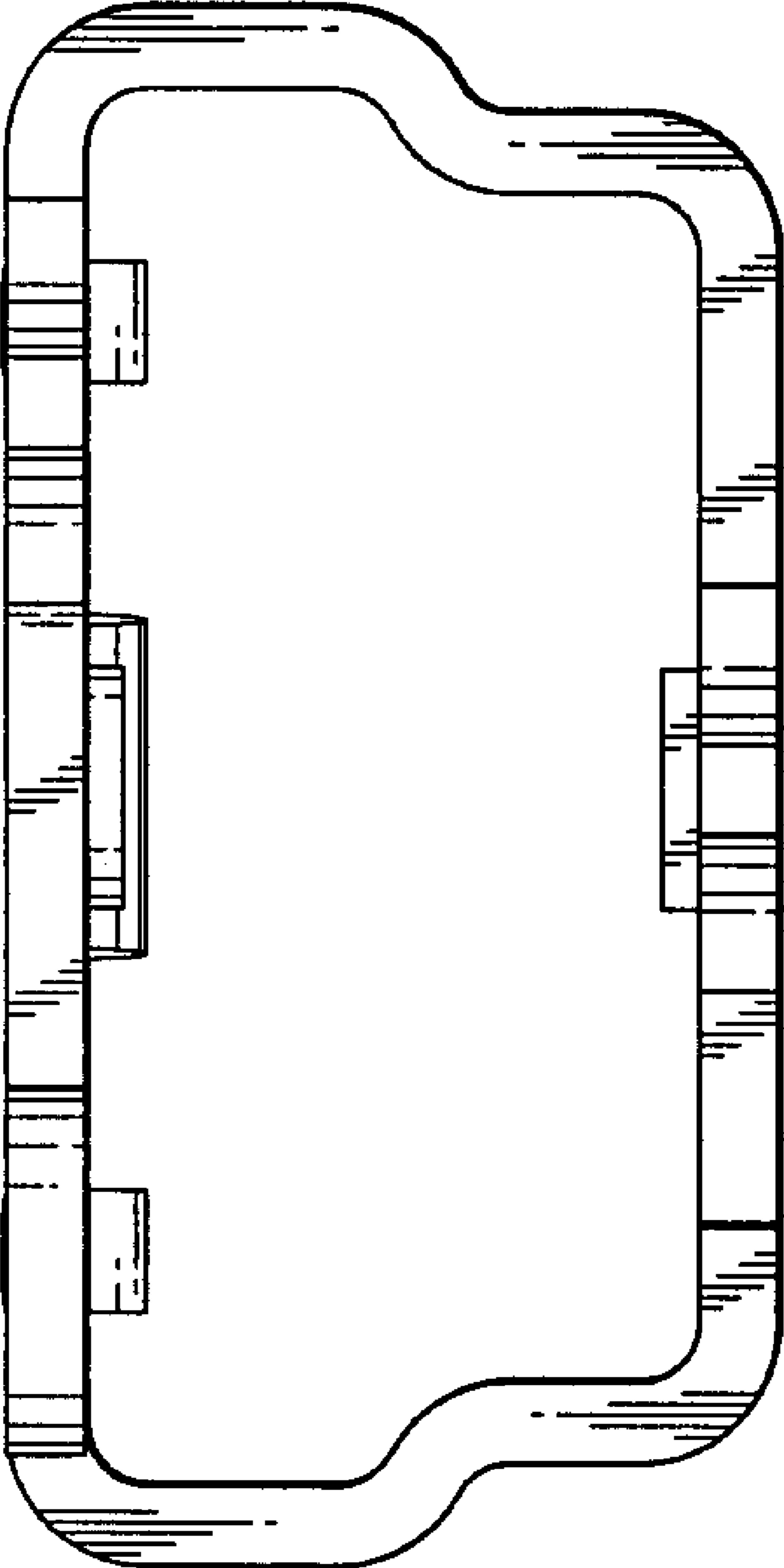

FIG. 3

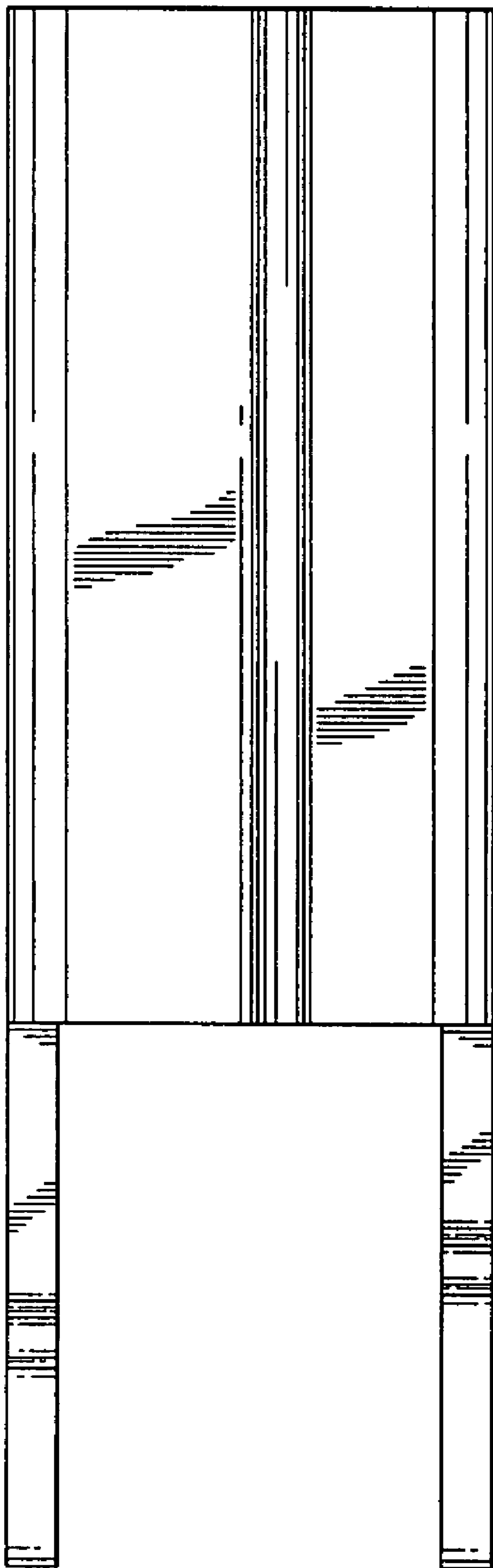

FIG. 4

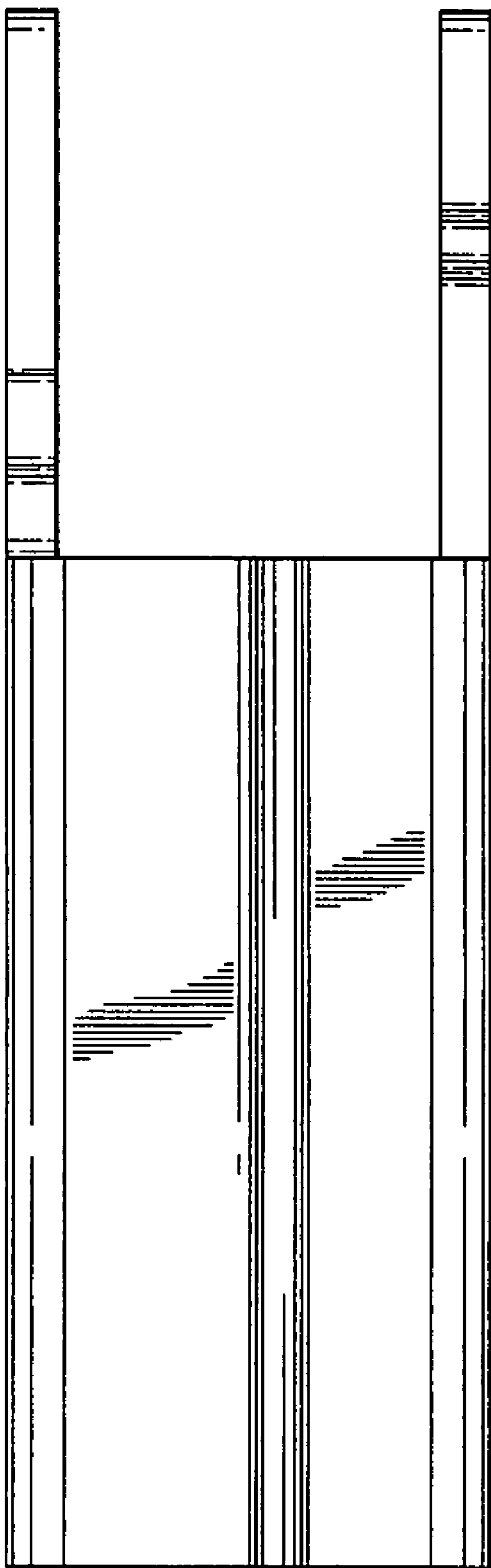

FIG. 5

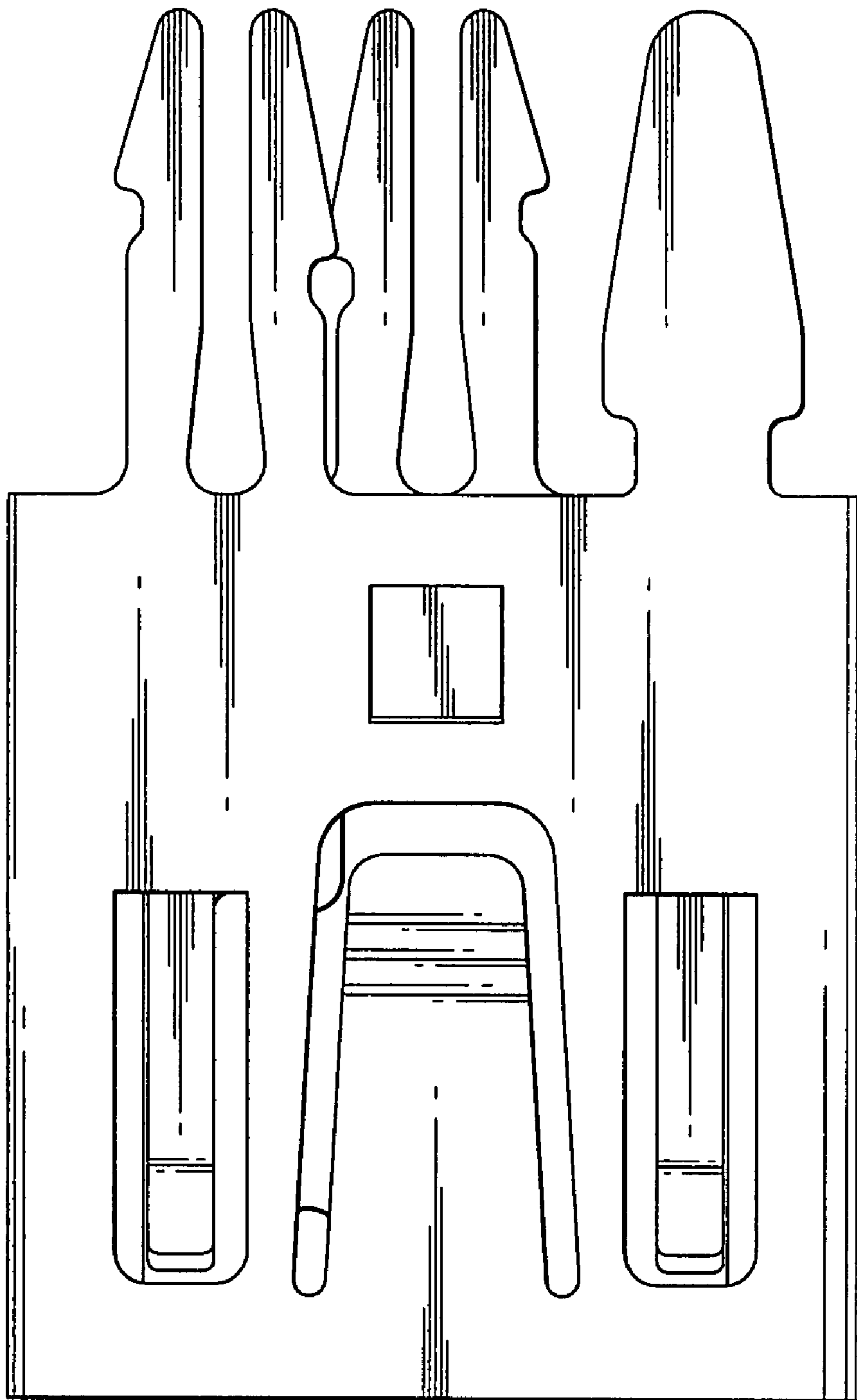

FIG. 6

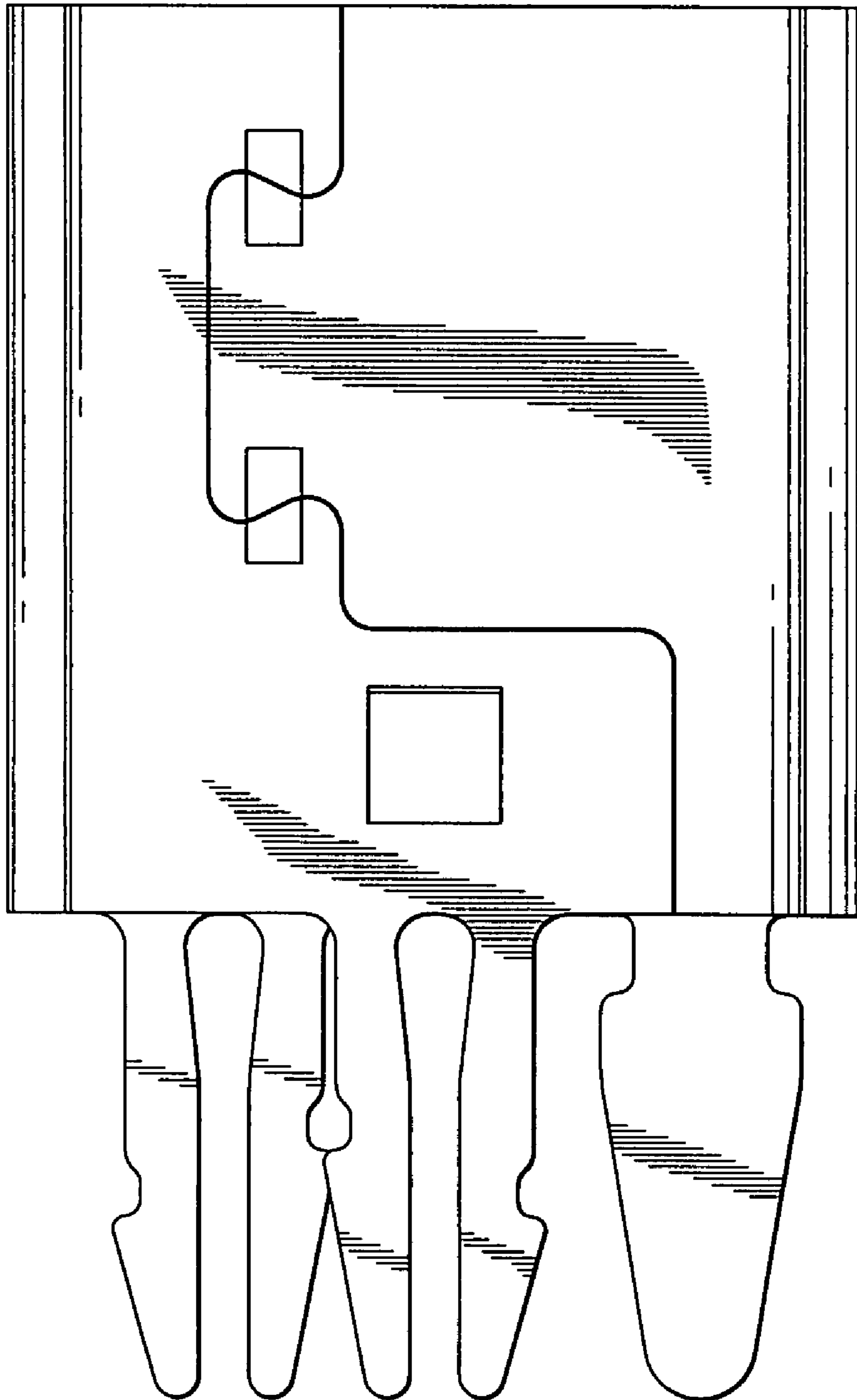

FIG. 7