



US00D585761S

(12) **United States Design Patent**  
**Oates**

(10) **Patent No.:** **US D585,761 S**  
(45) **Date of Patent:** **\*\* Feb. 3, 2009**

(54) **BOTTLE**

D542,149 S \* 5/2007 Boucher ..... D9/686

(75) Inventor: **Benjamin Phalan Oates**, Kent (GB)

FOREIGN PATENT DOCUMENTS

(73) Assignee: **Conopco, Inc.**, Englewood Cliffs, NJ  
(US)

GB 3014698 \* 10/2003  
WO DM/049443 \* 10/1999  
WO DM/063700 \* 2/2003  
WO DM/063927 \* 6/2003

(\*\*) Term: **14 Years**

OTHER PUBLICATIONS

(21) Appl. No.: **29/293,918**

Oates: Co-Pending U.S. Appl. No. 29/293,926; For: Jar.  
Oates: Co-Pending U.S. Appl. No. 29/293,927; For: Cap.

(22) Filed: **Dec. 18, 2007**

\* cited by examiner

(30) **Foreign Application Priority Data**

*Primary Examiner*—Catherine Tuttle  
(74) *Attorney, Agent, or Firm*—Milton L. Honig

Jun. 18, 2007 (GB) ..... 4003200

(57) **CLAIM**

(51) **LOC (9) Cl.** ..... **09-01**

The ornamental design for a bottle, substantially as shown and described.

(52) **U.S. Cl.** ..... **D9/686**

(58) **Field of Classification Search** ..... D9/682–694,  
D9/516–575, 435–450; 215/379, 382–384;  
220/662, 665, 669; 222/631, 635, 209, 211–213,  
222/215, 321.7–321.9, 372, 373, 378, 379,  
222/383.1, 384–386, 398, 400.7, 400.8, 401,  
222/402.1–402.25

**DESCRIPTION**

See application file for complete search history.

FIG. 1 is a perspective view of the bottle showing my new design;

FIG. 2 is a front elevational view thereof;

FIG. 3 is a rear elevational view thereof;

FIG. 4 is a top plan view thereof;

FIG. 5 is a bottom plan view thereof;

FIG. 6 is a left side elevational view thereof; and,

FIG. 7 is a right side elevational view thereof.

The broken lines are included for the purpose of illustrating portions of the bottle, including structures seen through the transparent over cap and on the bottom end that form no part of the claimed design.

(56) **References Cited**

U.S. PATENT DOCUMENTS

D437,212 S \* 2/2001 Adachi et al. .... D9/686  
D458,137 S \* 6/2002 Bakic ..... D9/448  
D469,684 S \* 2/2003 Lerolle ..... D9/682  
D493,364 S \* 7/2004 Papiernik ..... D9/687  
D515,421 S \* 2/2006 Rossignol ..... D9/448  
D521,386 S \* 5/2006 Priestman ..... D9/529  
D526,201 S \* 8/2006 Bakic ..... D9/522  
D527,277 S \* 8/2006 Blasko et al. .... D9/693

**1 Claim, 3 Drawing Sheets**

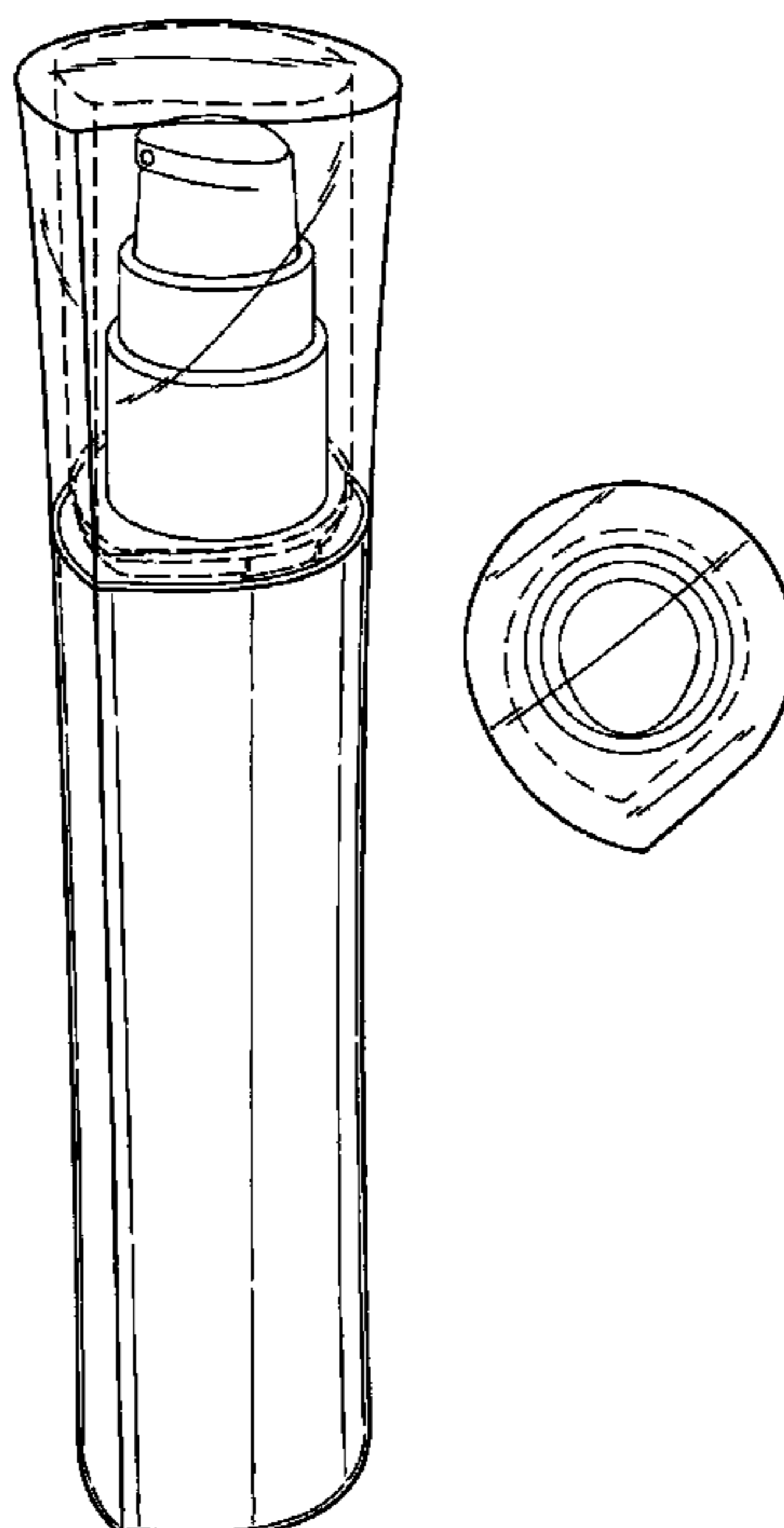

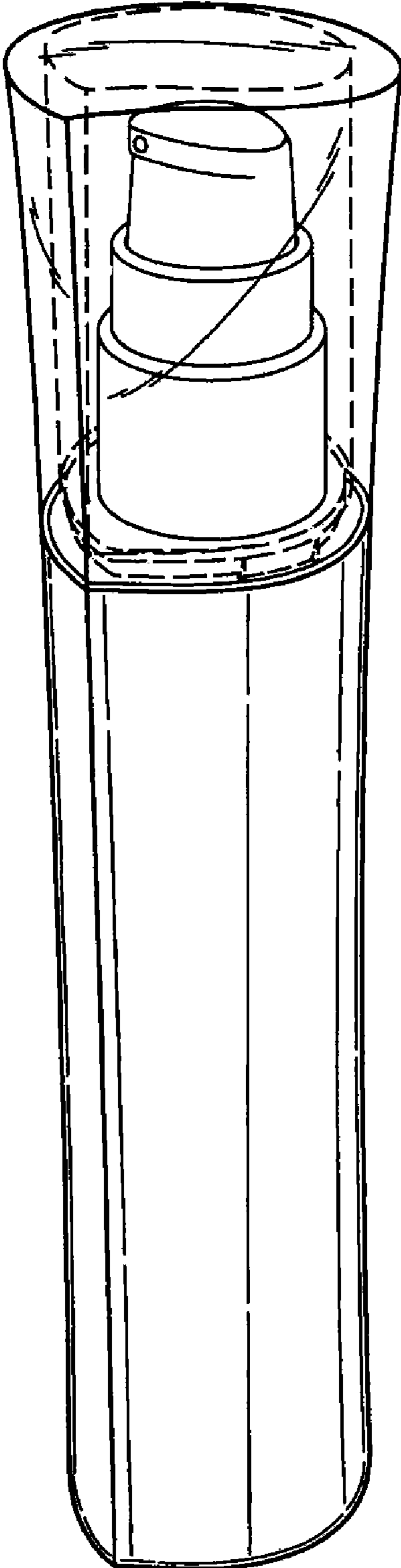

Fig. 1.

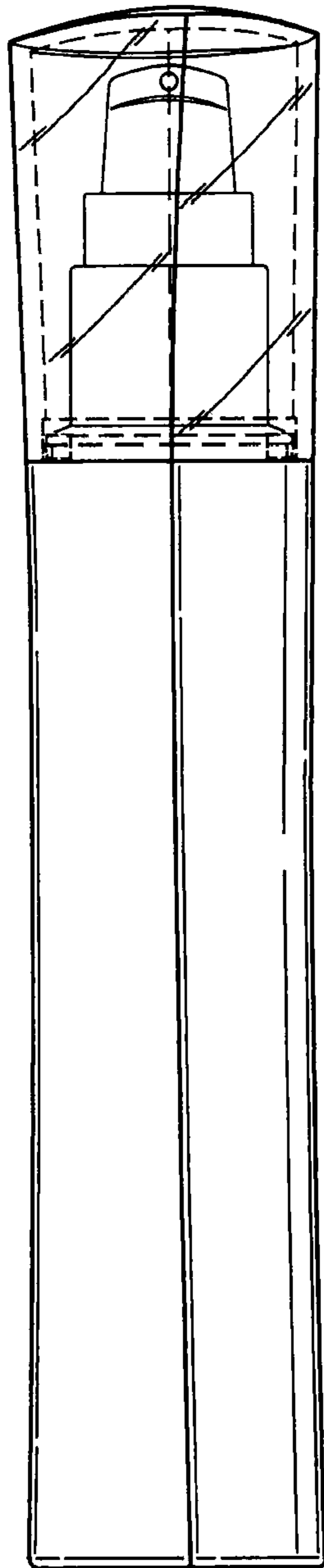

Fig.2.

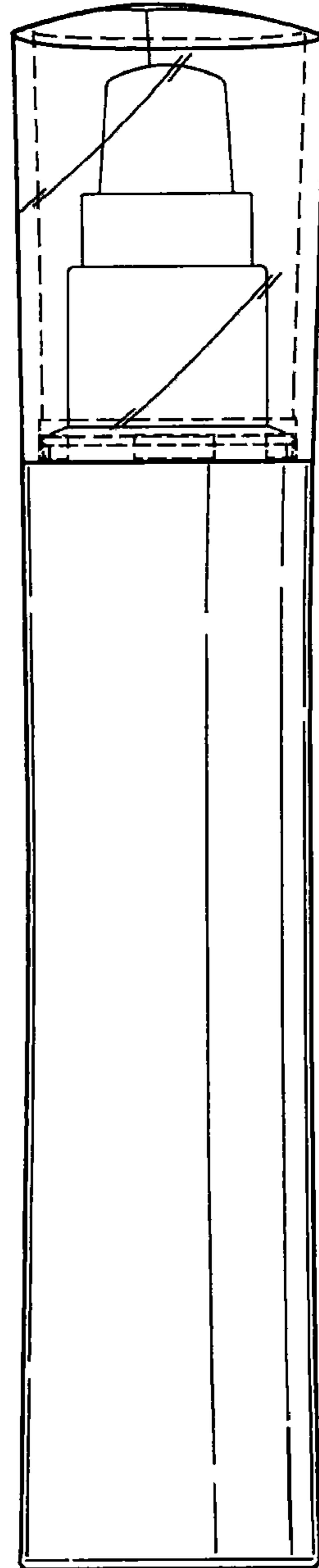

Fig.3.

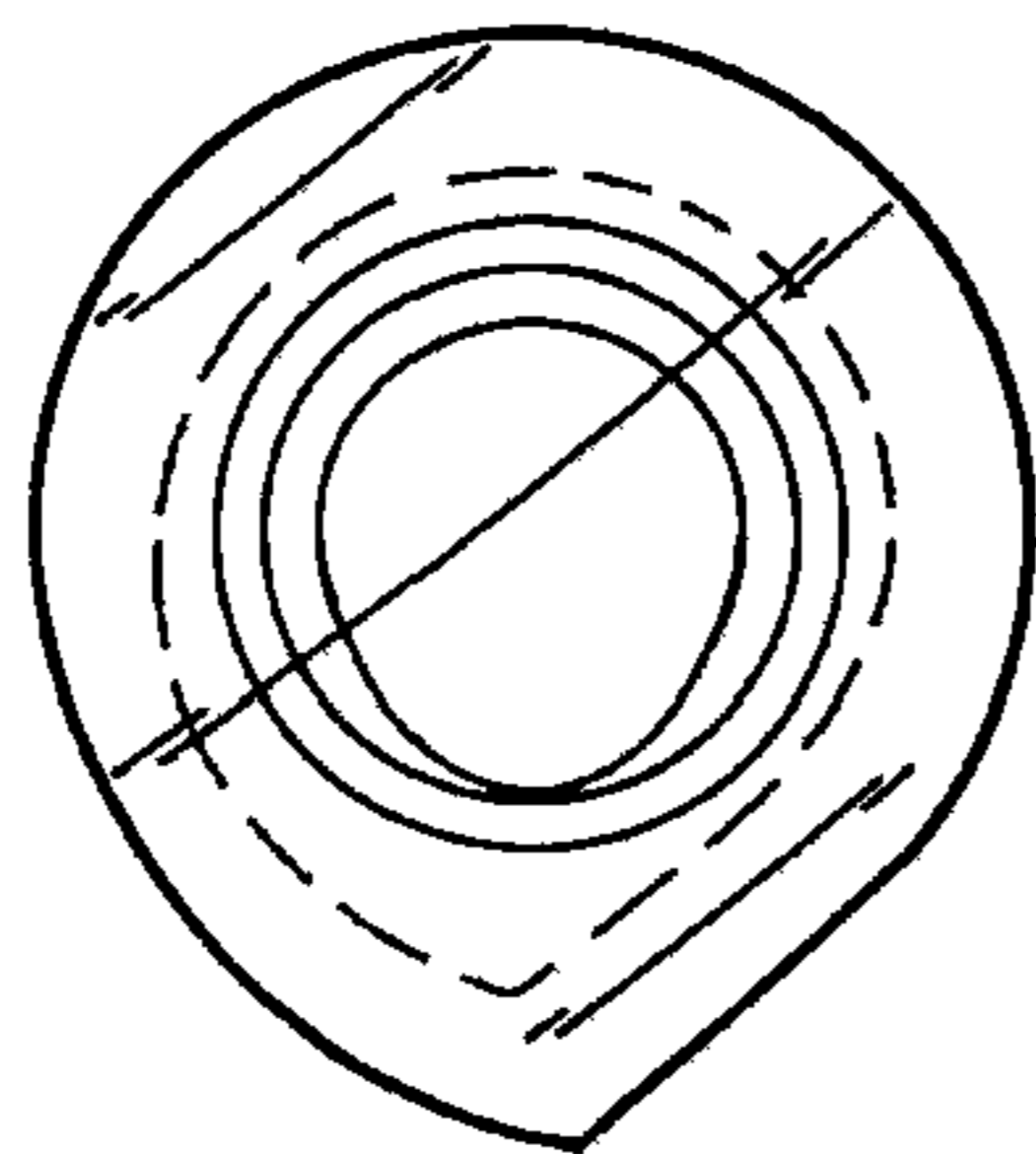

Fig.4.

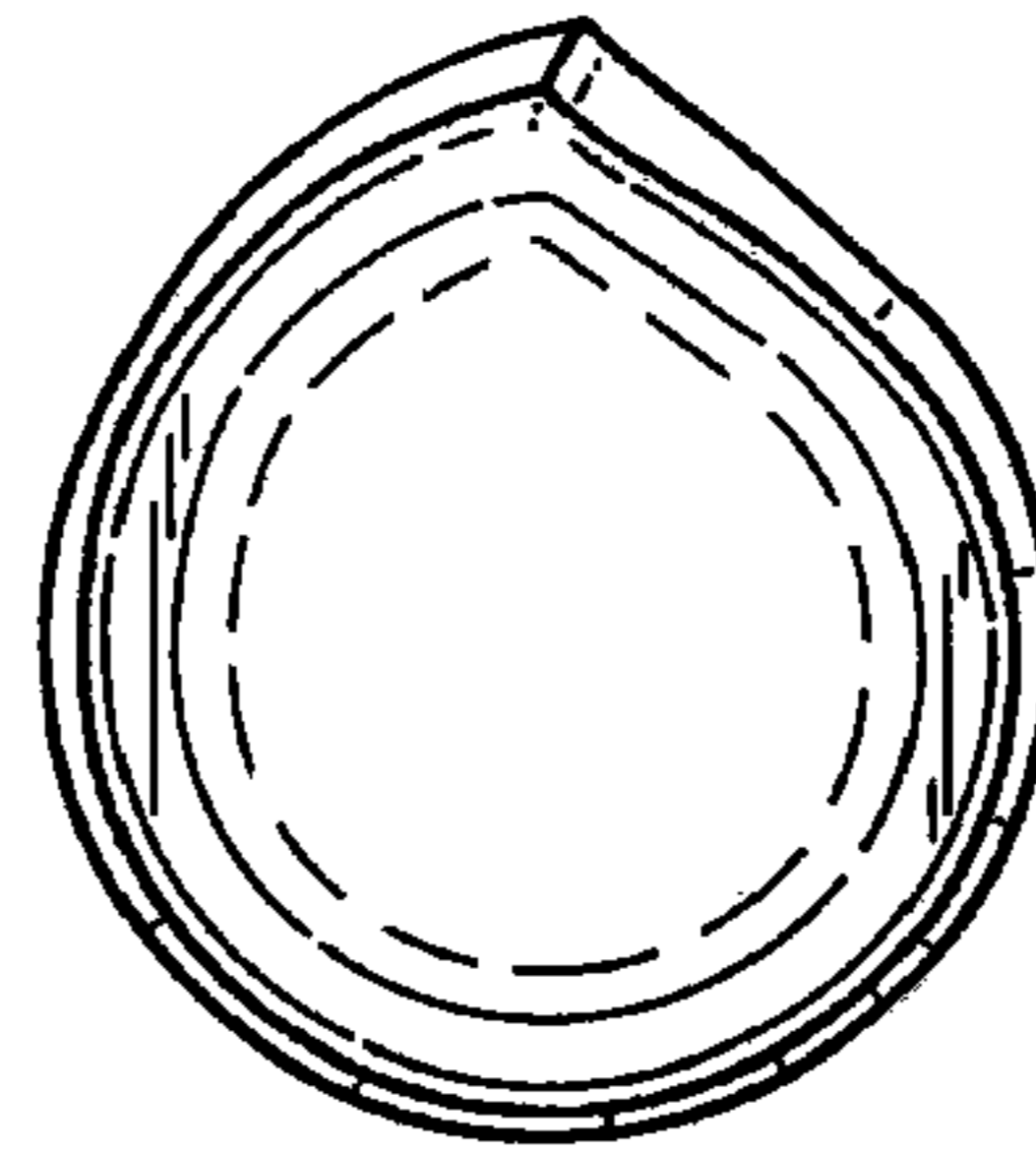

Fig.5.

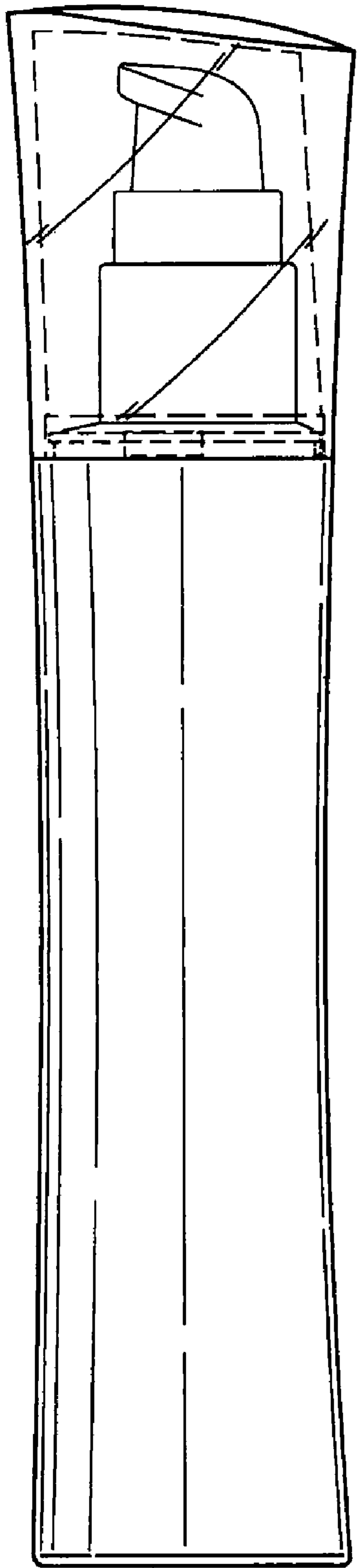

Fig. 6.

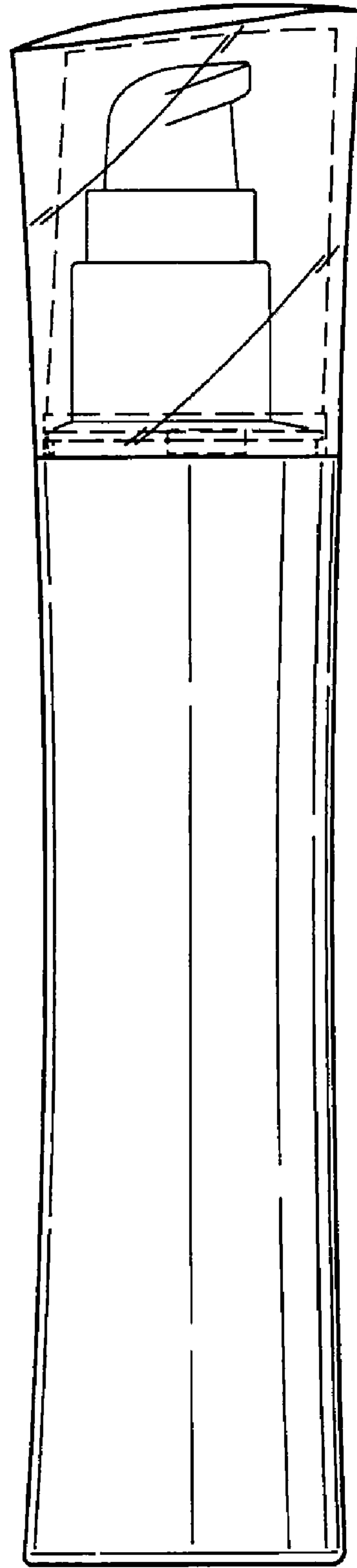

Fig. 7.

UNITED STATES PATENT AND TRADEMARK OFFICE  
**CERTIFICATE OF CORRECTION**

PATENT NO. : Des. 585,761 S  
APPLICATION NO. : 29/293918  
DATED : February 3, 2009  
INVENTOR(S) : Oates

Page 1 of 1

It is certified that error appears in the above-identified patent and that said Letters Patent is hereby corrected as shown below:

Title Page, Item (73) Assignee

“Conopco, Inc., Englewood Cliffs, NJ” should read -- Conopco, Inc., d/b/a Unilever,  
Englewood Cliffs, NJ --.

Signed and Sealed this

Seventeenth Day of March, 2009



JOHN DOLL  
*Acting Director of the United States Patent and Trademark Office*