



US00D585759S

(12) **United States Design Patent**  
**Lindsay**

(10) **Patent No.:** **US D585,759 S**  
(45) **Date of Patent:** **\*\* Feb. 3, 2009**

(54) **BASE FOR A CONTAINER**

D516,950 S \* 3/2006 Thorsteinsson ..... D21/658  
D568,553 S \* 5/2008 Rutherford et al. .... D21/658

(75) Inventor: **Brendan Jon Lindsay**, Auckland (NZ)

\* cited by examiner

(73) Assignee: **Sistema Plastics Limited**, Auckland (NZ)

*Primary Examiner*—Sandra Morris

(\*\*) Term: **14 Years**

(74) *Attorney, Agent, or Firm*—Jacobson Holman PLLC

(21) Appl. No.: **29/300,224**

(57) **CLAIM**

(22) Filed: **Feb. 29, 2008**

The ornamental design for a base for a container, as shown and described.

(30) **Foreign Application Priority Data**

**DESCRIPTION**

Aug. 30, 2007 (NZ) ..... 409592

(51) **LOC (9) Cl.** ..... **09-01**

(52) **U.S. Cl.** ..... **D9/624**; D21/659

(58) **Field of Classification Search** ..... D3/270–271.3;  
D7/594, 599, 613, 619.2, 628; D9/600, 614,  
D9/616, 618–624; D21/621, 658–659; 206/457,  
206/459.5; 220/890

See application file for complete search history.

FIG. 1 is a side perspective view showing my new design for a base for a container,

FIG. 2 is a front perspective top view thereof,

FIG. 3 is a bottom perspective view thereof,

FIG. 4 is another bottom perspective view thereof,

FIG. 5 is a front view thereof,

FIG. 6 is a rear view thereof,

FIG. 7 is a plan view thereof; and,

FIG. 8 is a bottom view thereof.

(56) **References Cited**

**U.S. PATENT DOCUMENTS**

D437,822 S \* 2/2001 Gray ..... D21/658

**1 Claim, 4 Drawing Sheets**

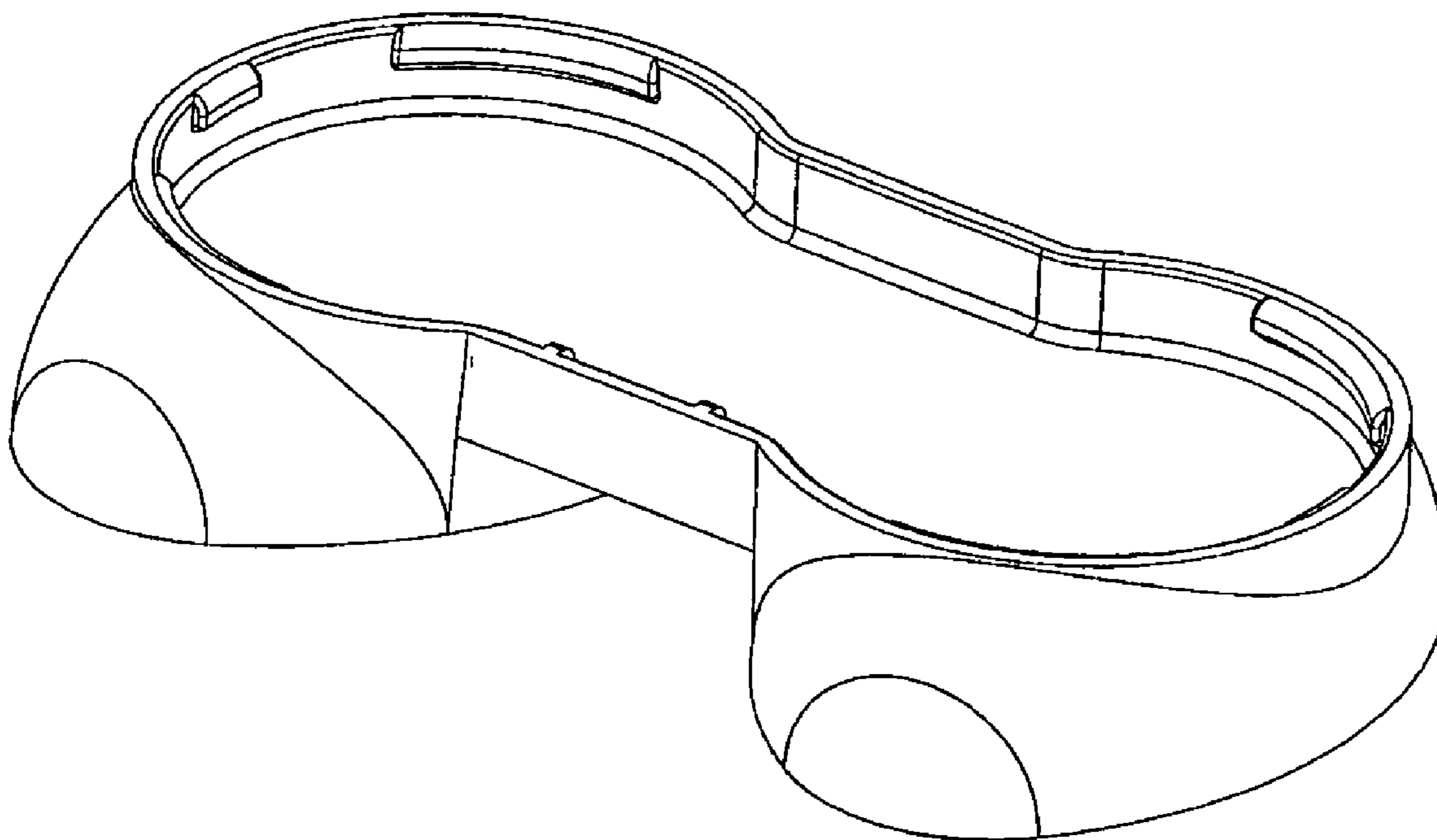

FIG. 1

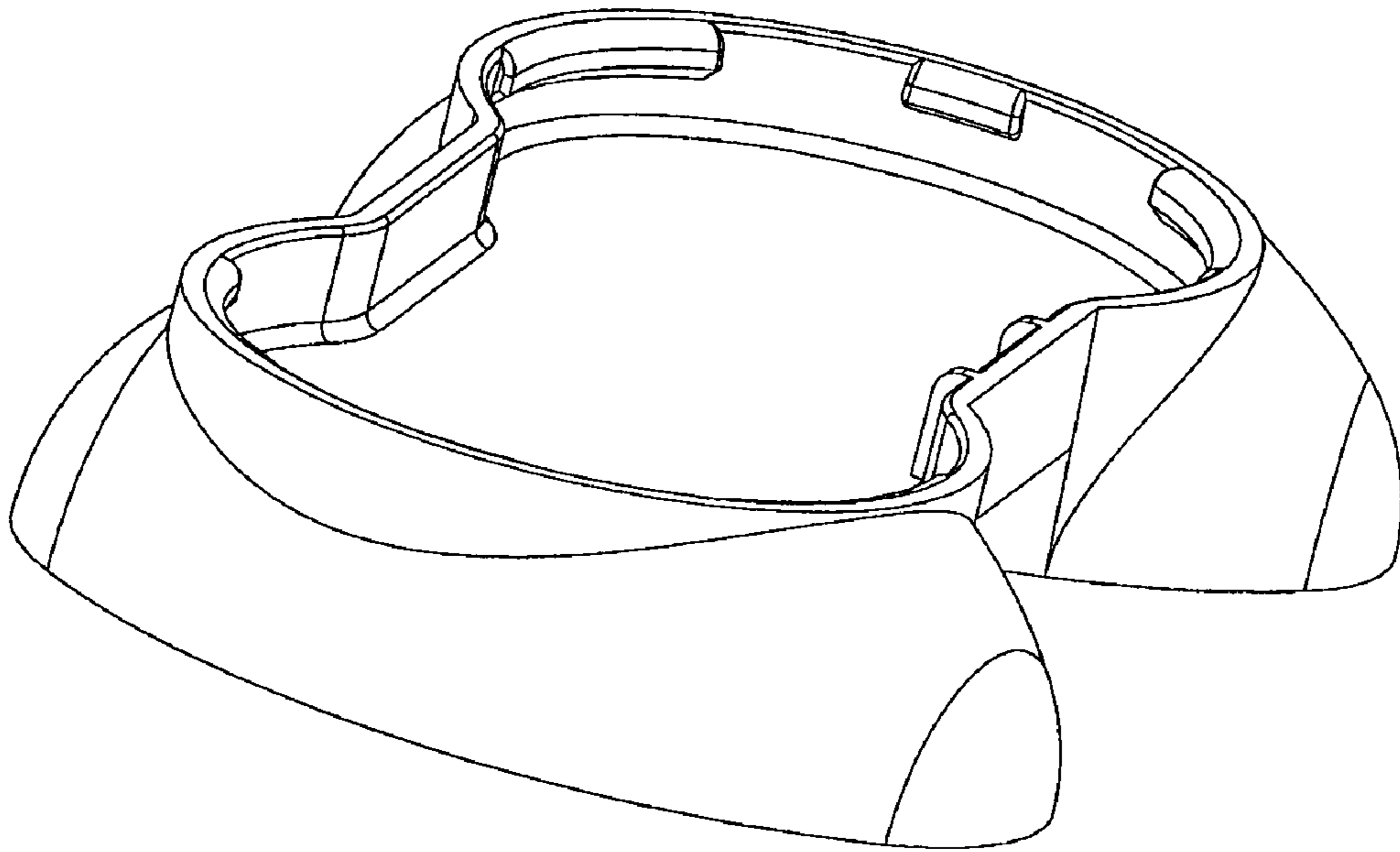

FIG. 2

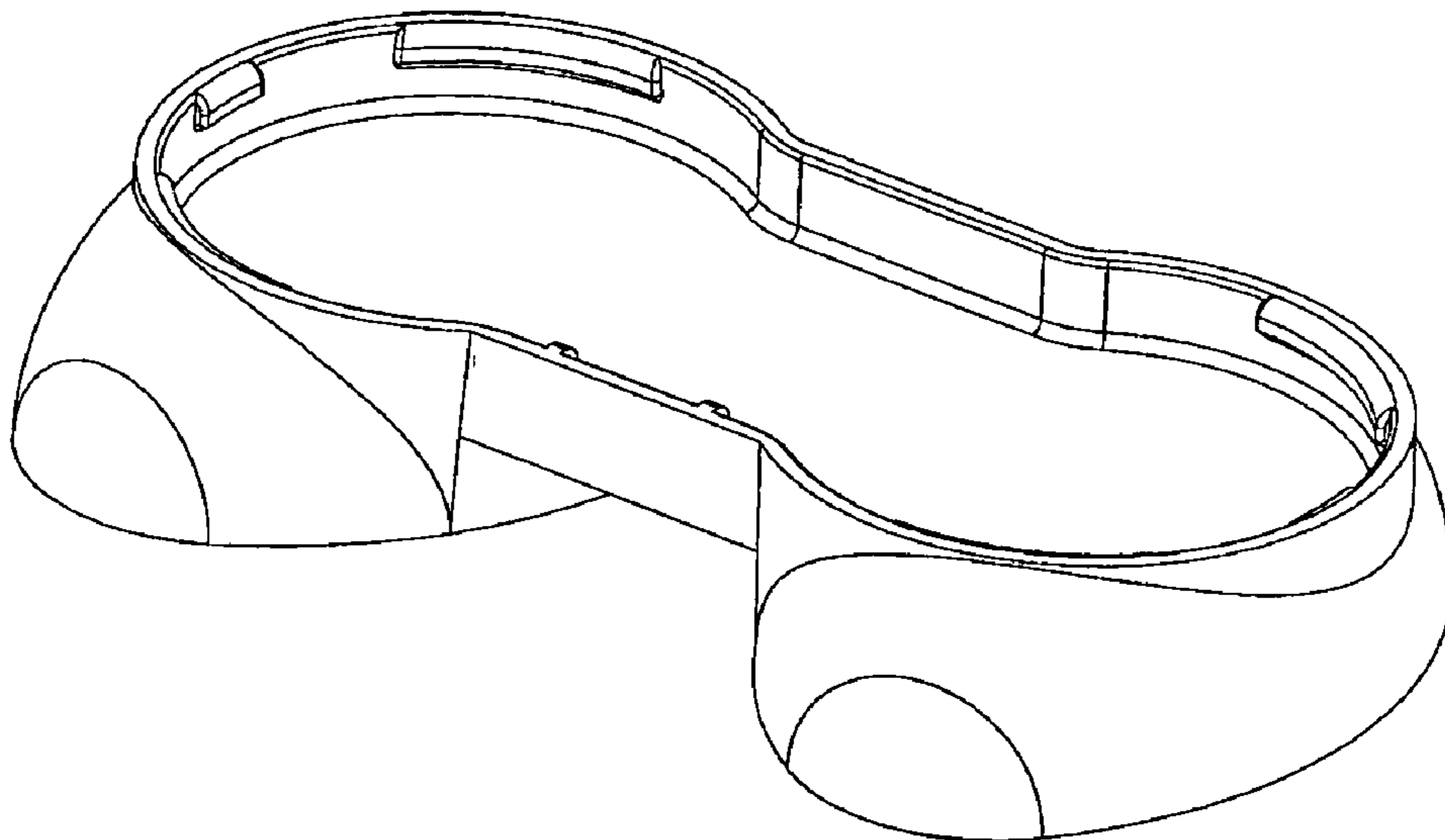

FIG. 3

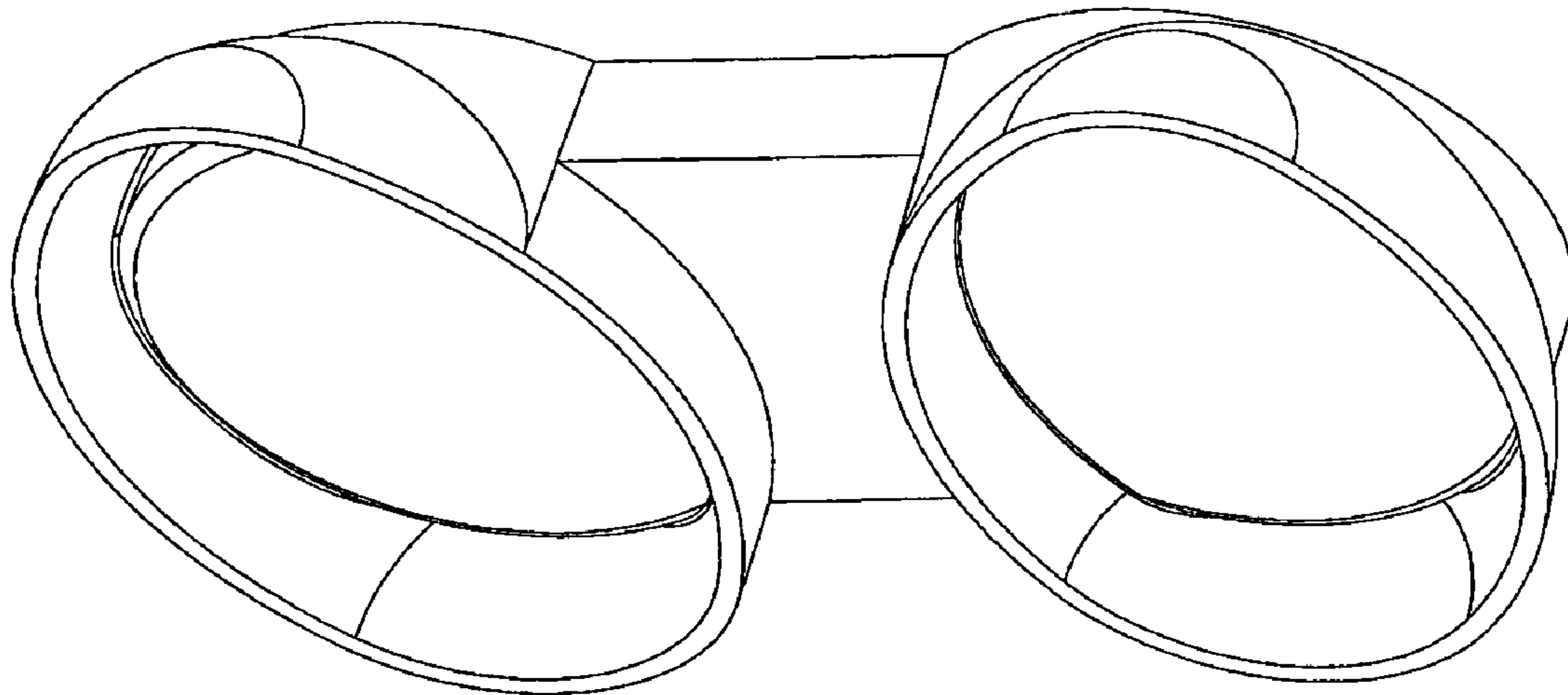

FIG. 4

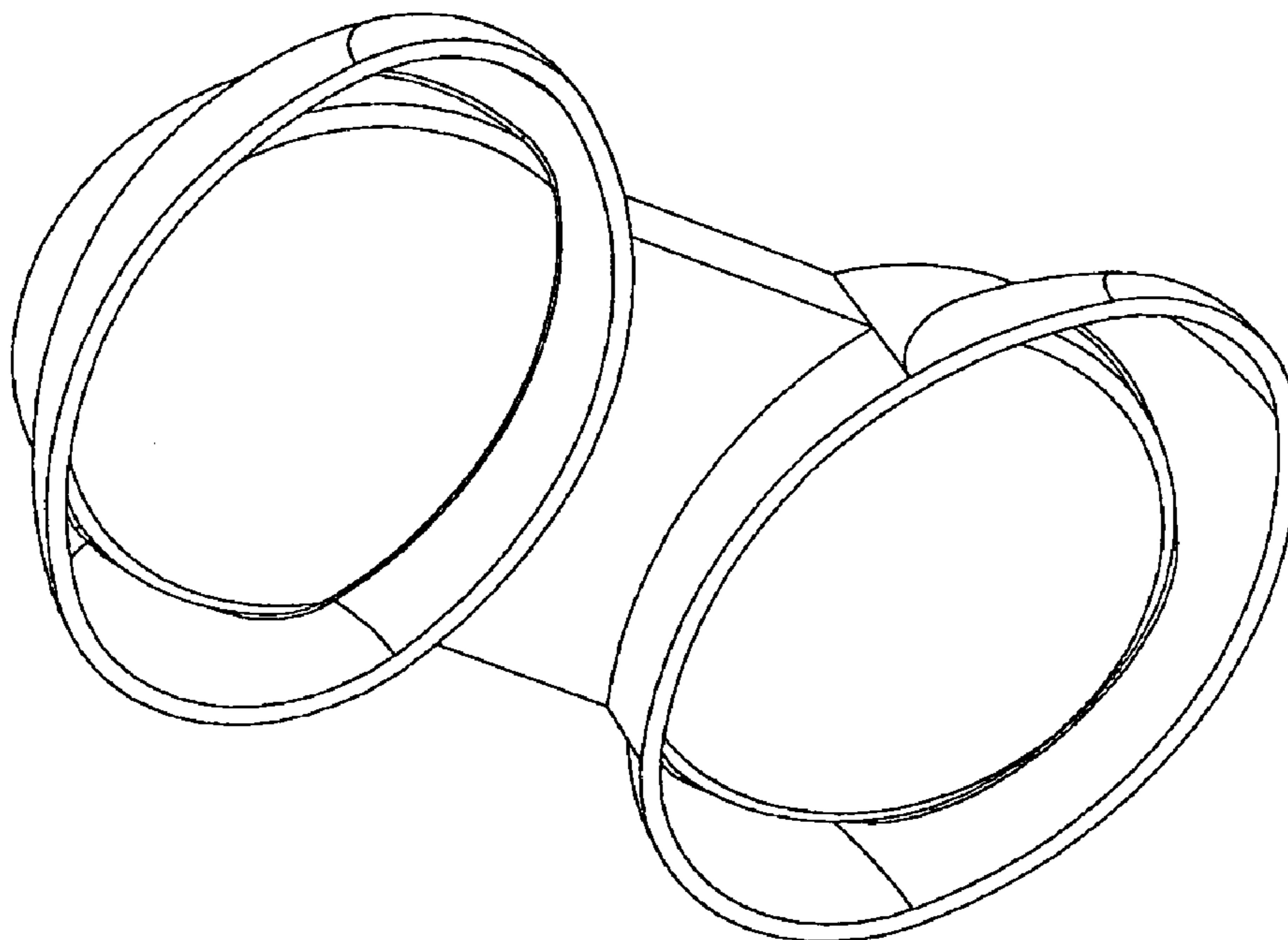

FIG. 5

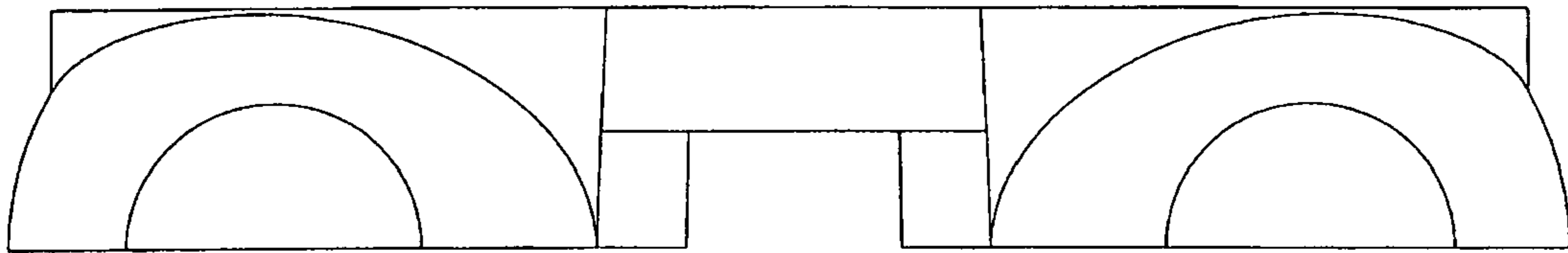

FIG. 6

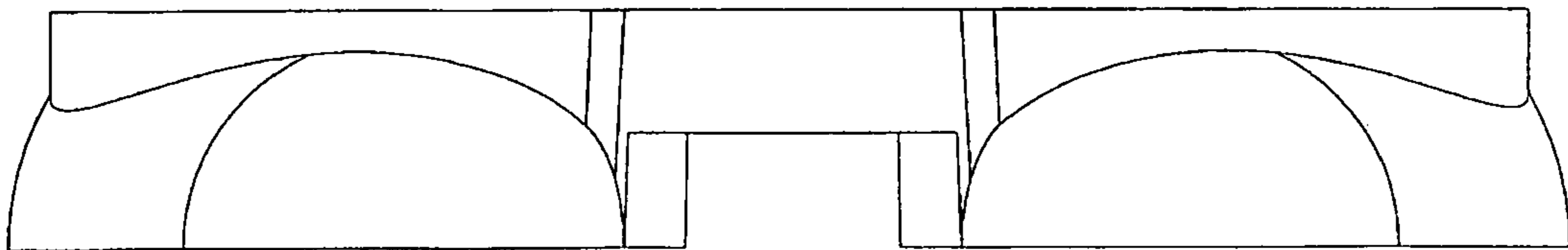

FIG. 7

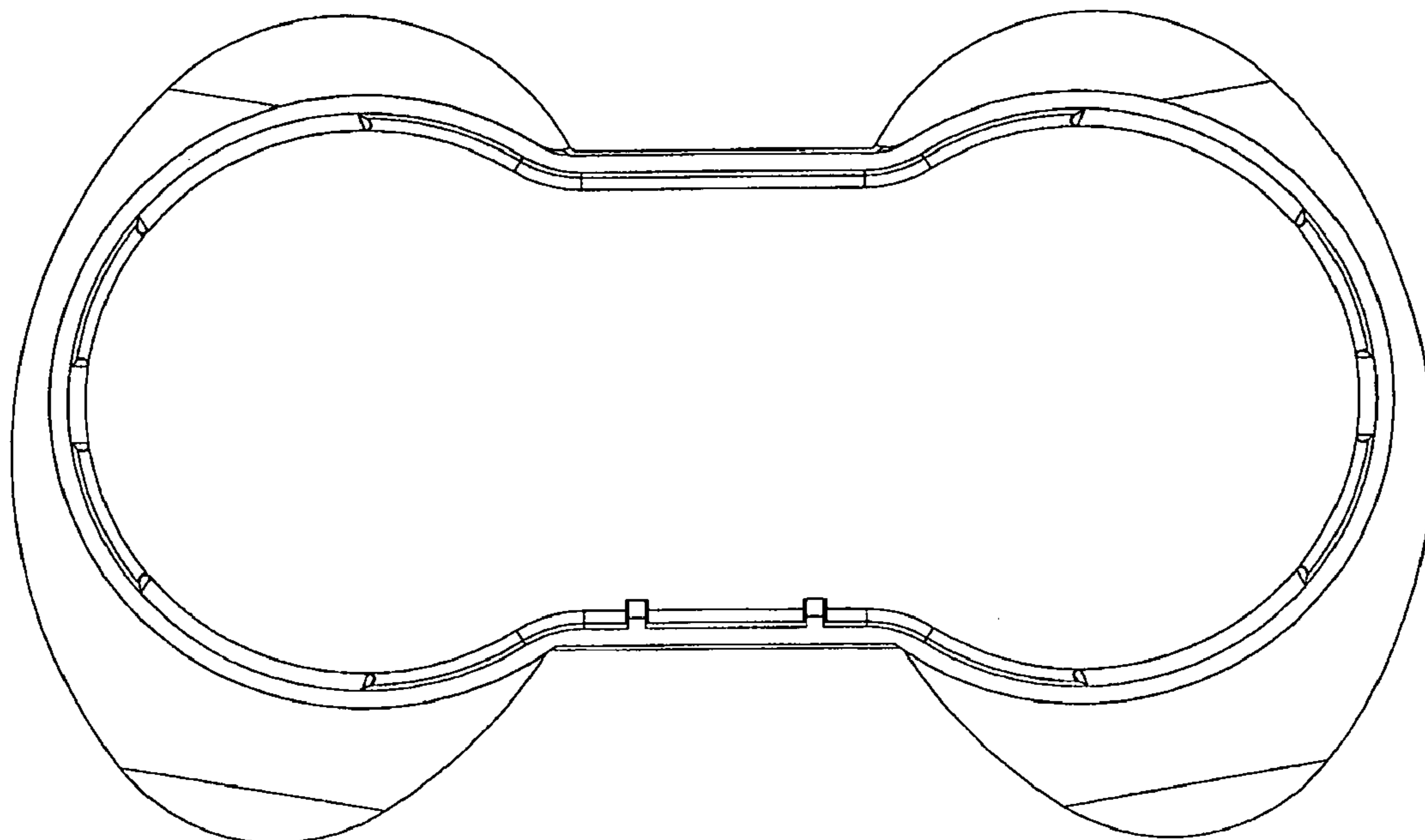

FIG. 8

