



US00D585742S

(12) **United States Design Patent**
Wilson et al.

(10) **Patent No.:** **US D585,742 S**

(45) **Date of Patent:** **** Feb. 3, 2009**

(54) **NON-DRIP SPOUT**

(75) Inventors: **Tracie Lynn Clemons Wilson**,
Westminster, MD (US); **Steve Gift**, Lititz,
PA (US)

(73) Assignee: **McCormick & Company, Inc.**, Sparks,
MD (US)

(**) Term: **14 Years**

(21) Appl. No.: **29/322,206**

(22) Filed: **Jul. 30, 2008**

Related U.S. Application Data

(62) Division of application No. 29/250,547, filed on Nov.
20, 2006.

(51) **LOC (9) Cl.** **09-07**

(52) **U.S. Cl.** **D9/449; D9/454; D9/453**

(58) **Field of Classification Search** D9/453,
D9/450, 449, 446, 438; 222/571, 567, 566,
222/545, 544, 484, 481.5, 480; 220/810;
215/556, 235; D28/82

See application file for complete search history.

(56) **References Cited**

U.S. PATENT DOCUMENTS

447,502 A	3/1891	Wright	
1,648,512 A	11/1927	Stock	
1,952,288 A *	3/1934	Saxon	222/569
2,203,133 A	6/1940	Englert	
D306,701 S *	3/1990	Beck	D9/446
D319,981 S *	9/1991	Sledge	D9/447
5,395,015 A *	3/1995	Bolen et al.	222/546
D363,025 S	10/1995	Deflander et al.	
5,651,481 A	7/1997	Jensen	

6,116,477 A	9/2000	Kreiseder et al.	
D508,402 S	8/2005	Hierzer et al.	
D508,853 S *	8/2005	Ziegenhorn et al.	D9/449
D576,877 S *	9/2008	Alcamo et al.	D9/449
2007/0095864 A1	5/2007	Vangeel et al.	

* cited by examiner

Primary Examiner—Susan B Hattan

(74) *Attorney, Agent, or Firm*—Oblon, Spivak, McClelland,
Maier & Neustadt, P.C.

(57) **CLAIM**

The ornamental design for a non-drip spout, as shown.

DESCRIPTION

FIG. 1 is a top and right front perspective view of a non-drip
spout;

FIG. 2 is a front elevational view thereof;

FIG. 3 is a right side elevational view thereof, the left side
elevational view being a mirror image of the side view shown;

FIG. 4 is a top plan view;

FIG. 5 is a rear elevational view;

FIG. 6 is a bottom plan view;

FIG. 7 is a top and right rear perspective view thereof;

FIG. 8 is a top and right front perspective view of a non-drip
spout shown in an open position when in use;

FIG. 9 is a front elevational view thereof;

FIG. 10 is a left side elevational view thereof, the right side
elevational view being a mirror image of the side view shown;

FIG. 11 is a top plan view thereof;

FIG. 12 is a rear elevational view thereof; and,

FIG. 13 is a bottom plan view thereof.

1 Claim, 7 Drawing Sheets

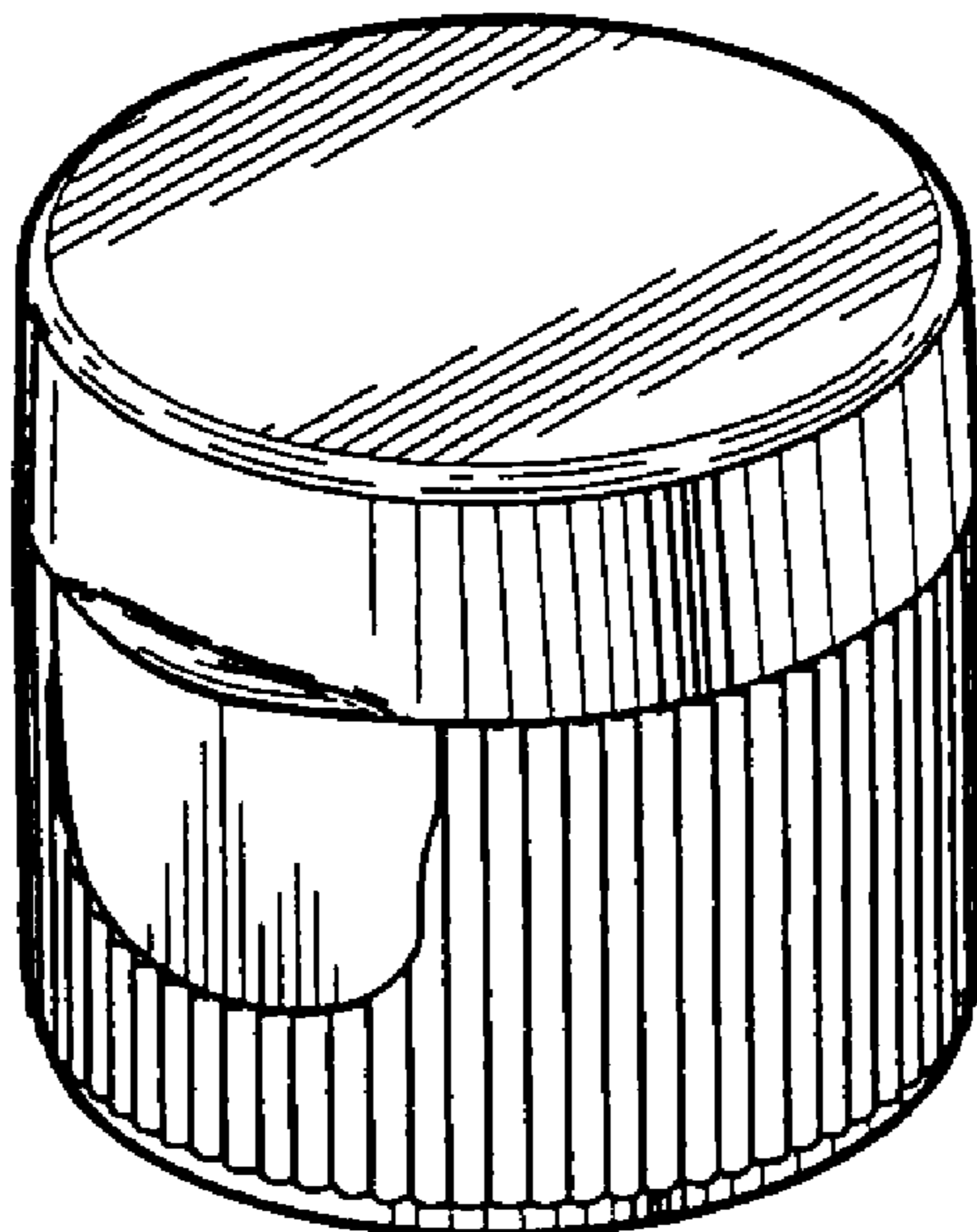

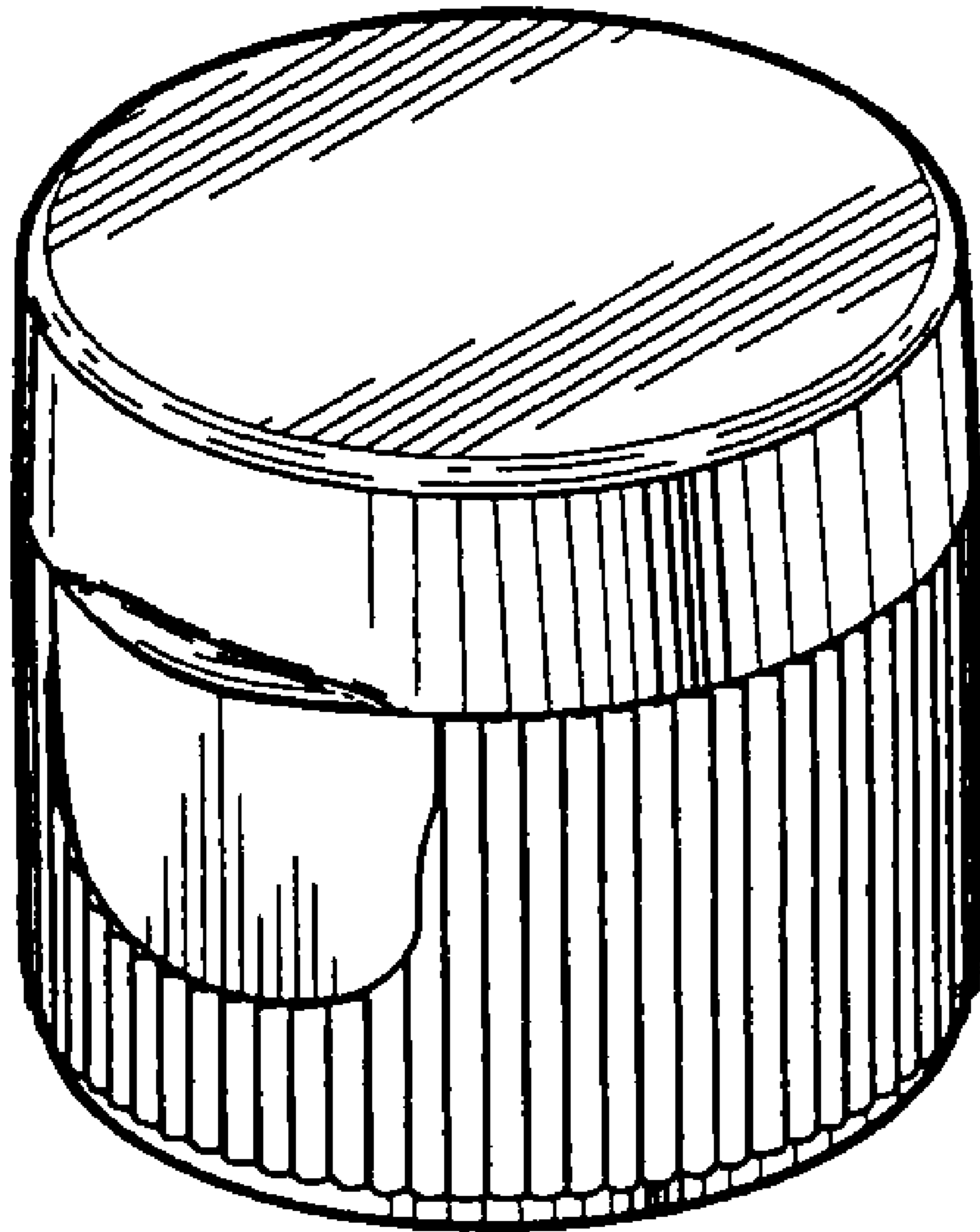

Fig. 1

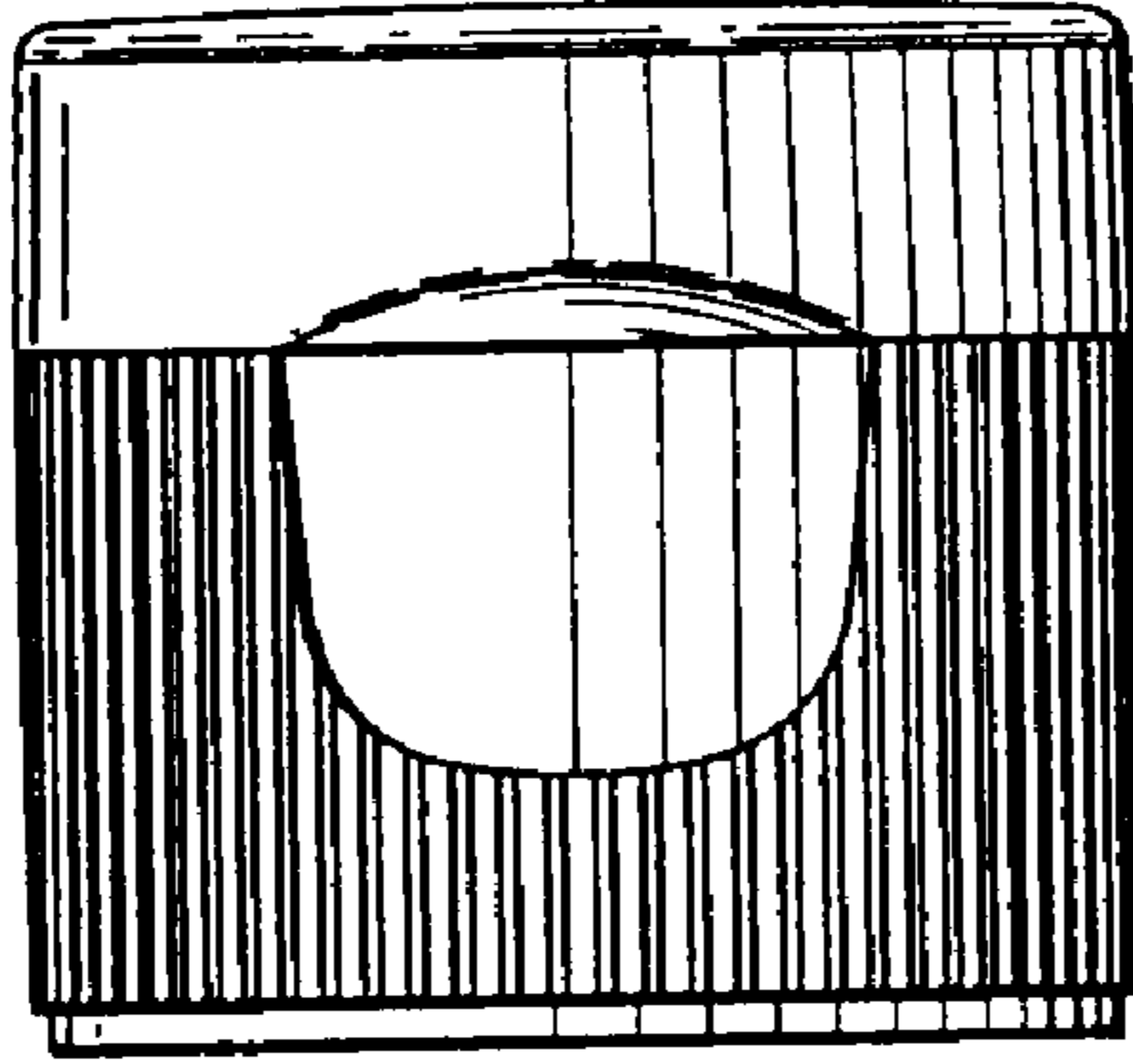

Fig. 2

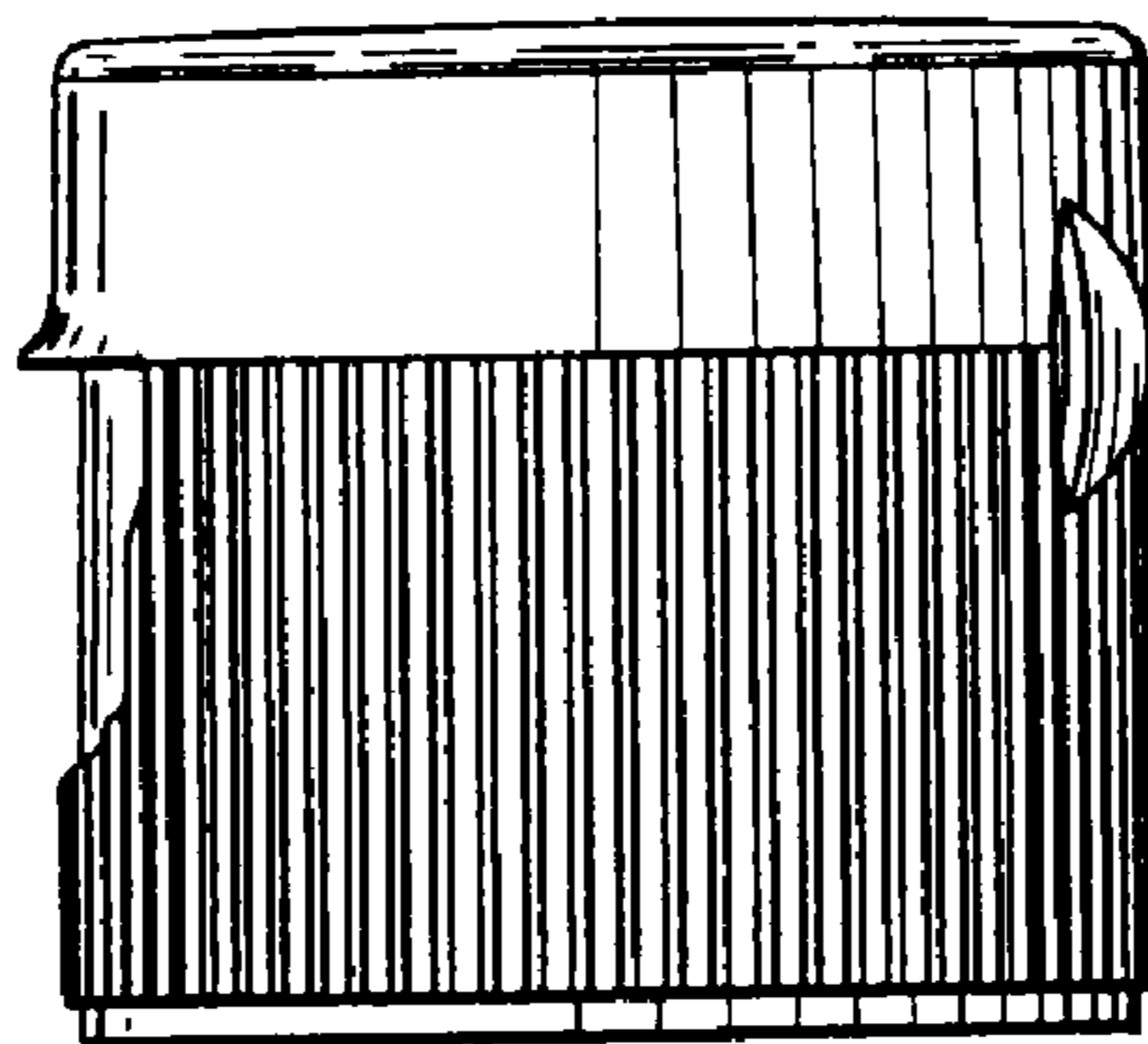

Fig. 3

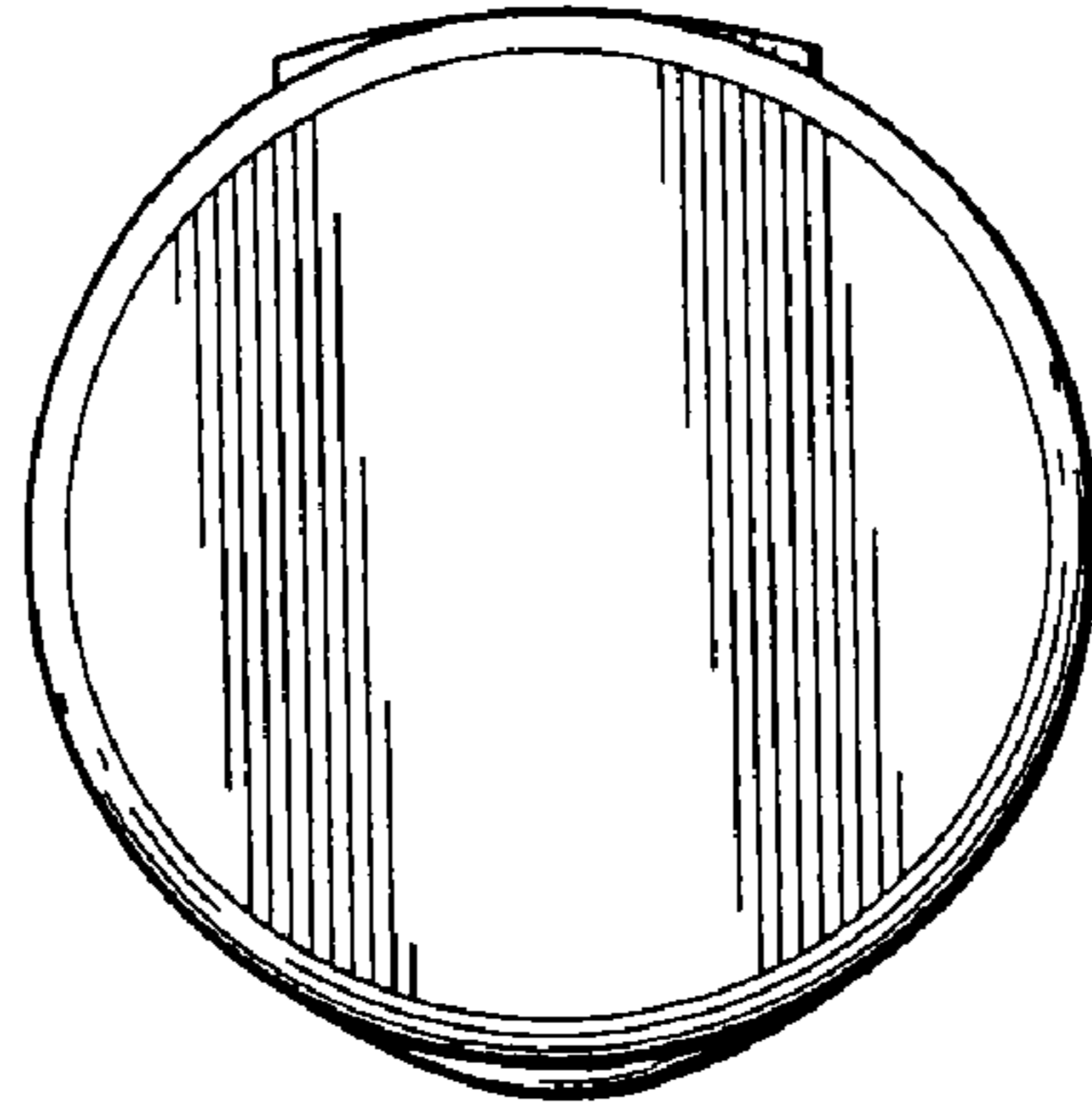

Fig. 4

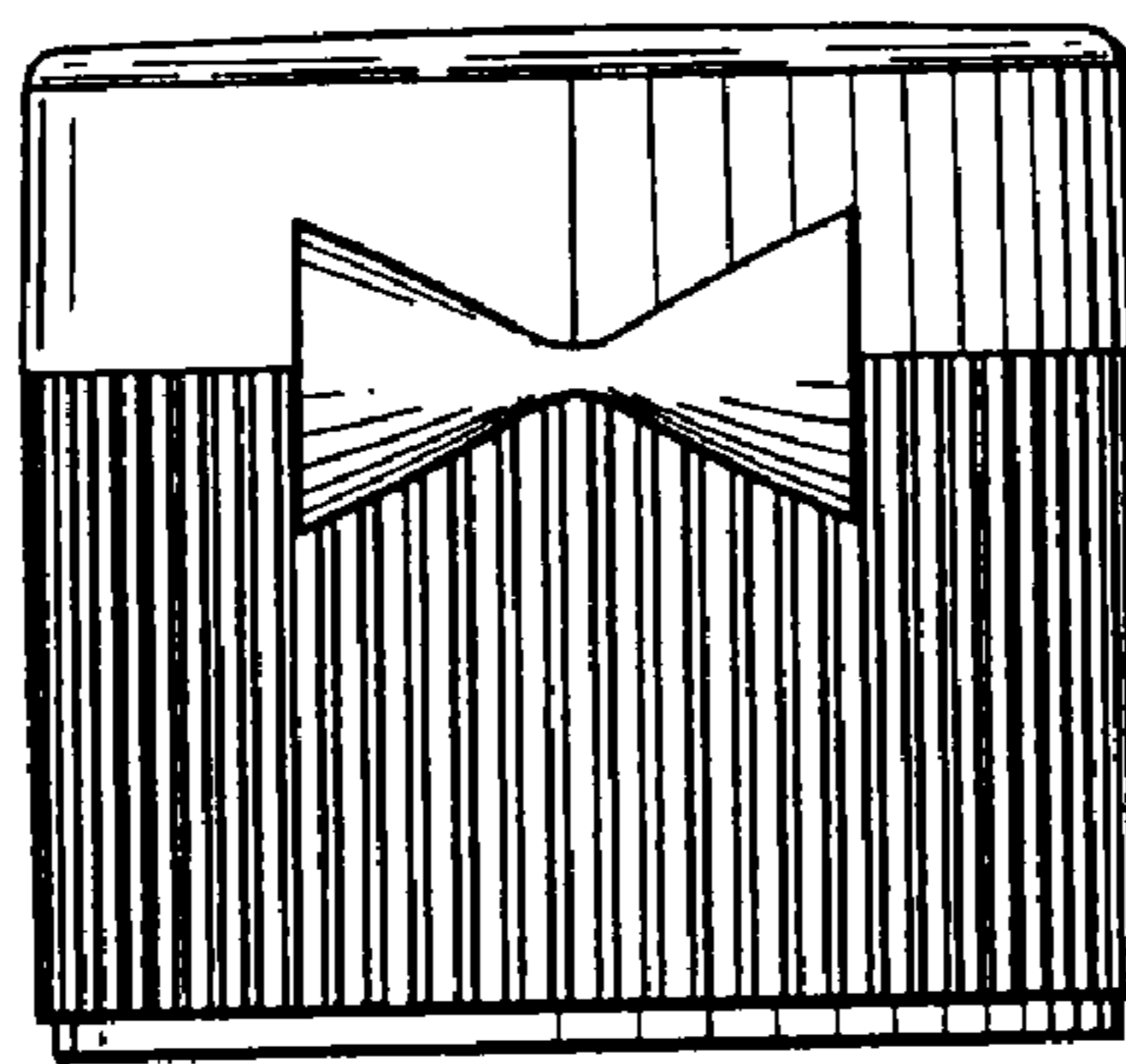

Fig. 5

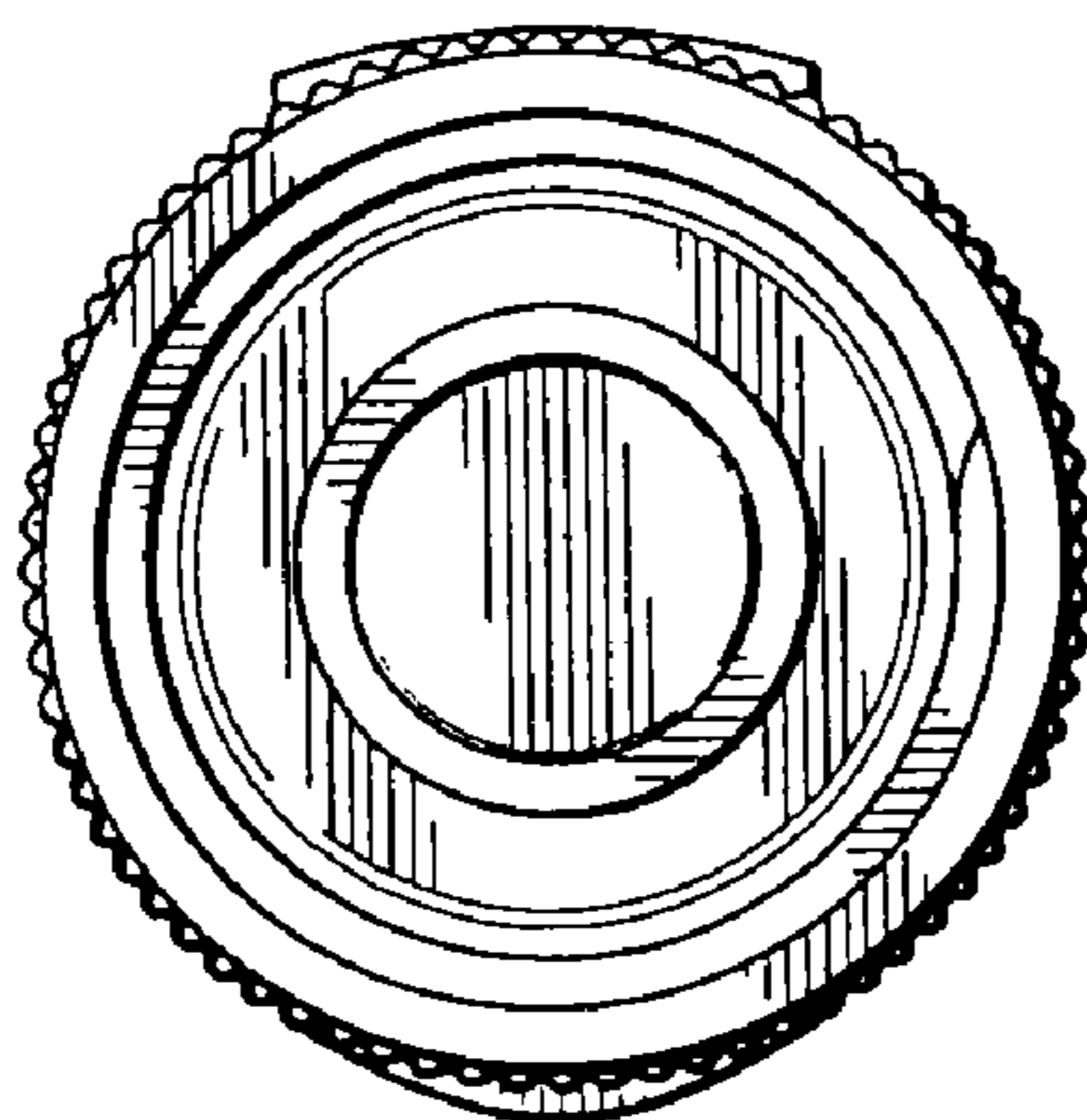

Fig. 6

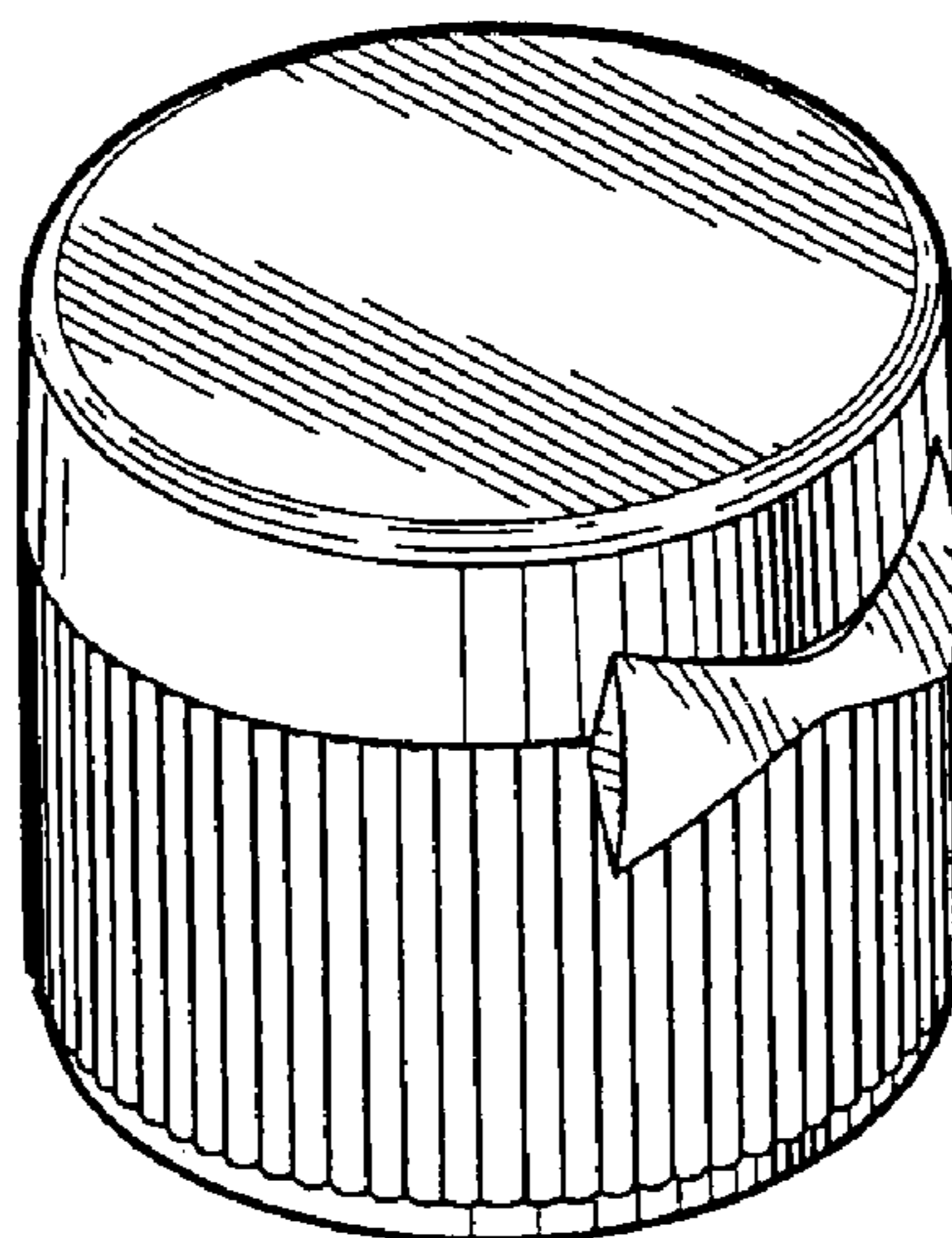

Fig. 7

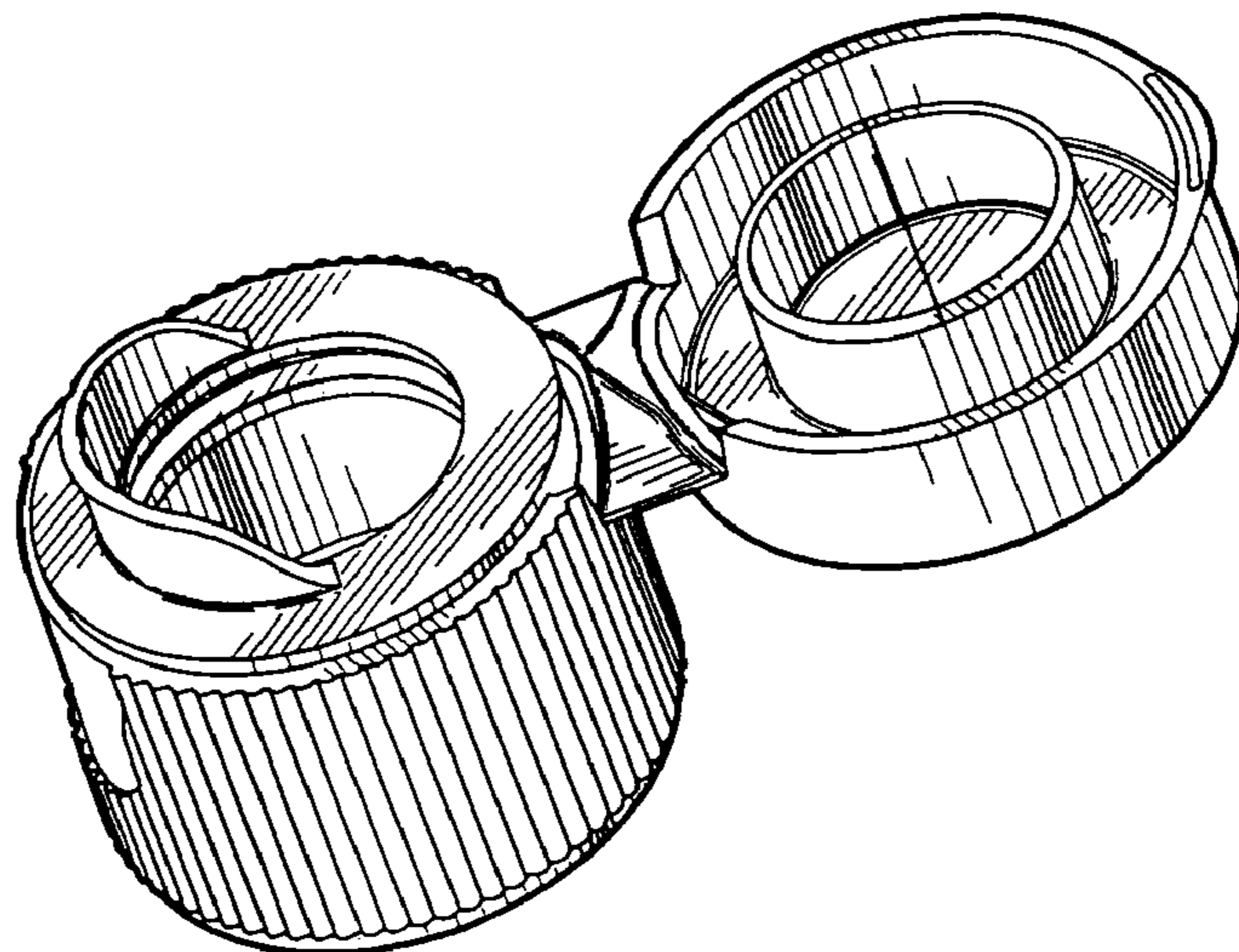

Fig. 8

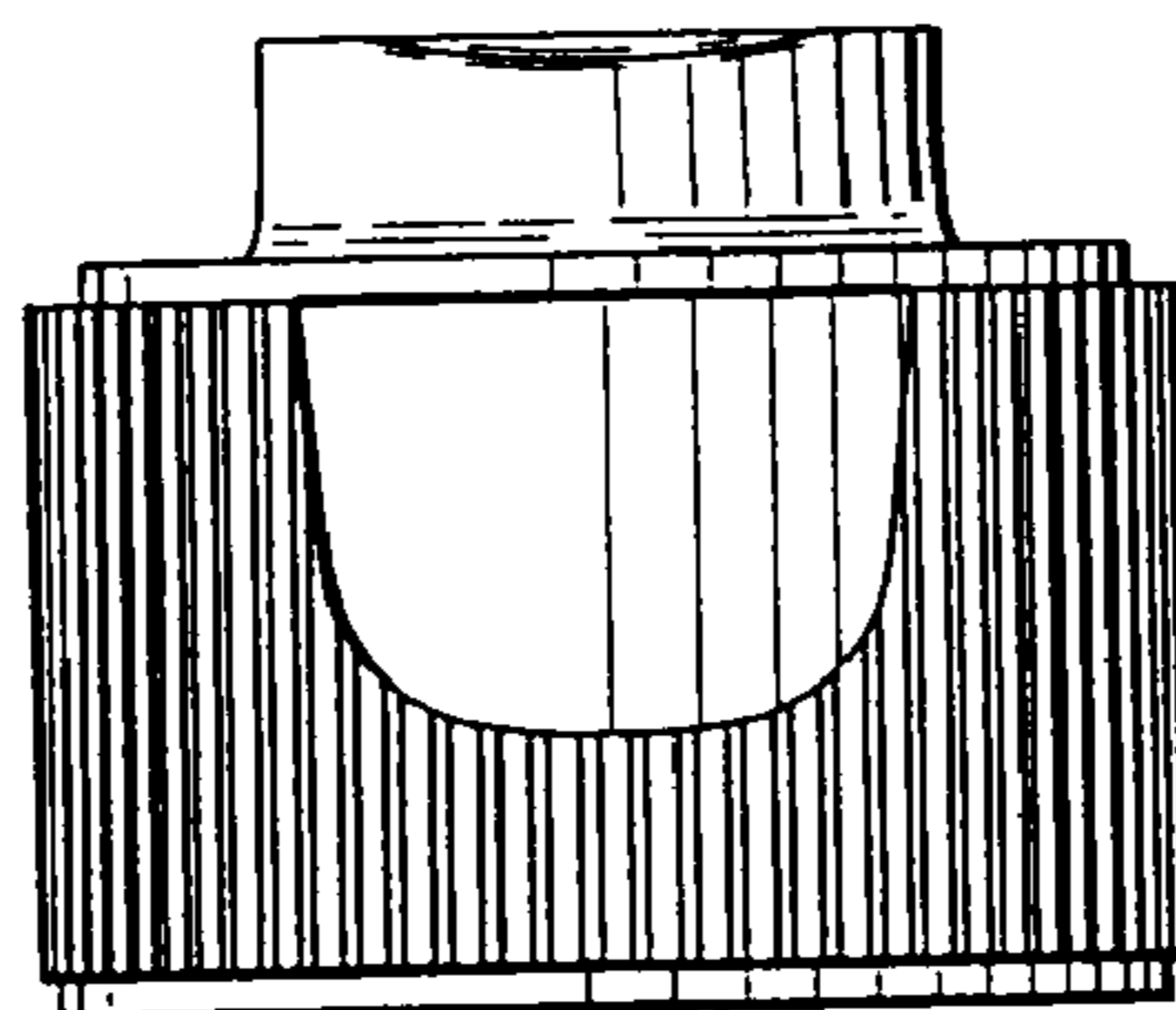

Fig. 9

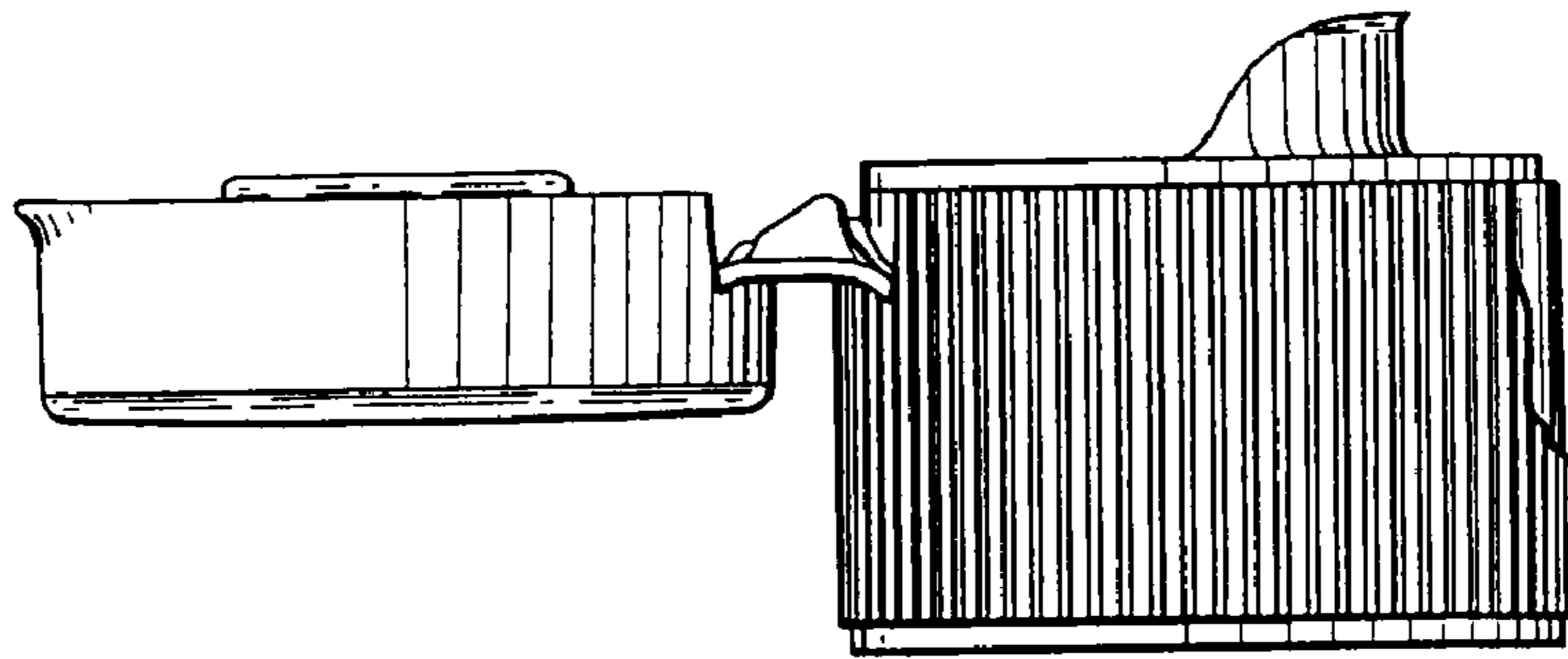

Fig. 10

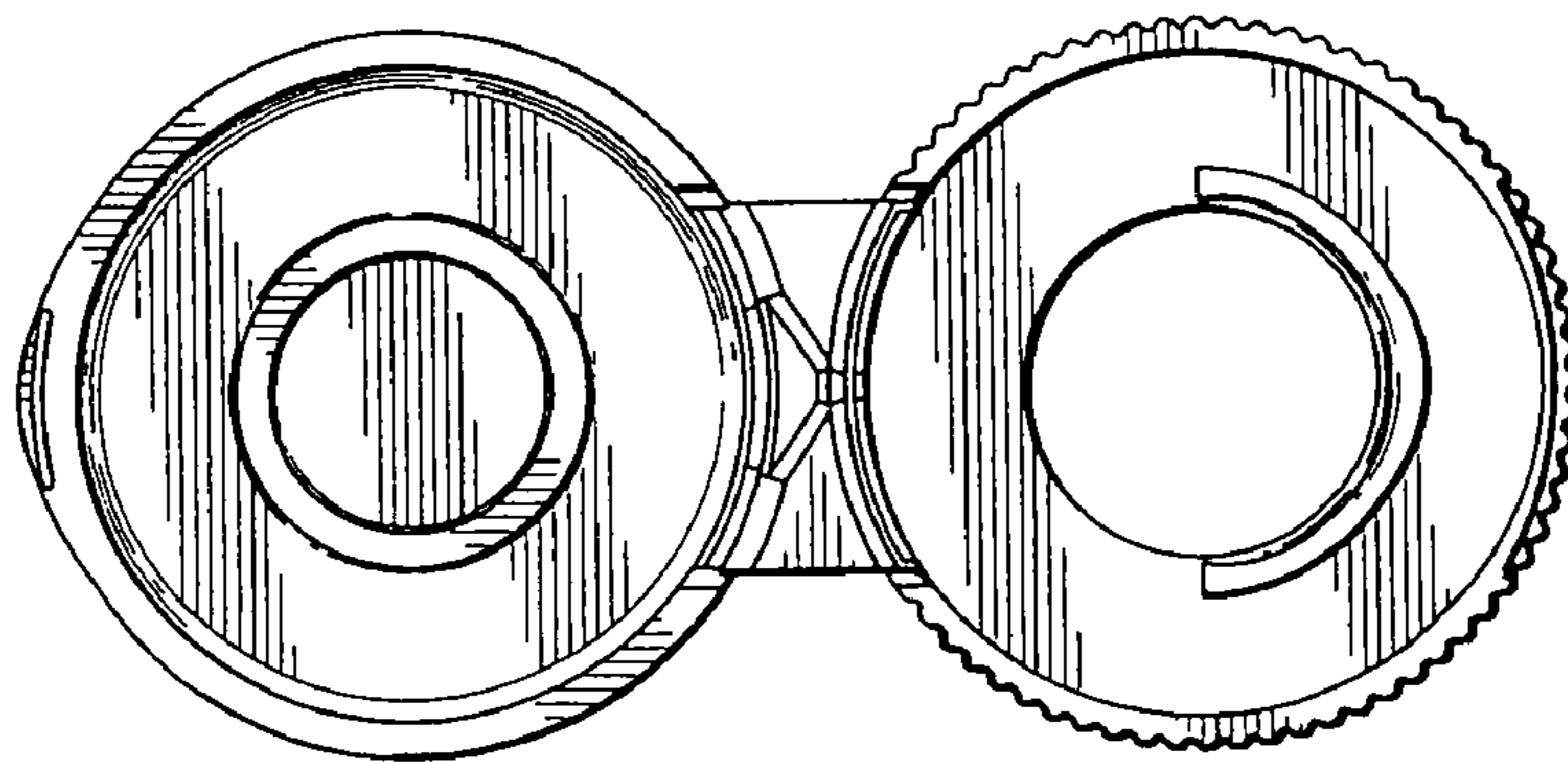

Fig. 11

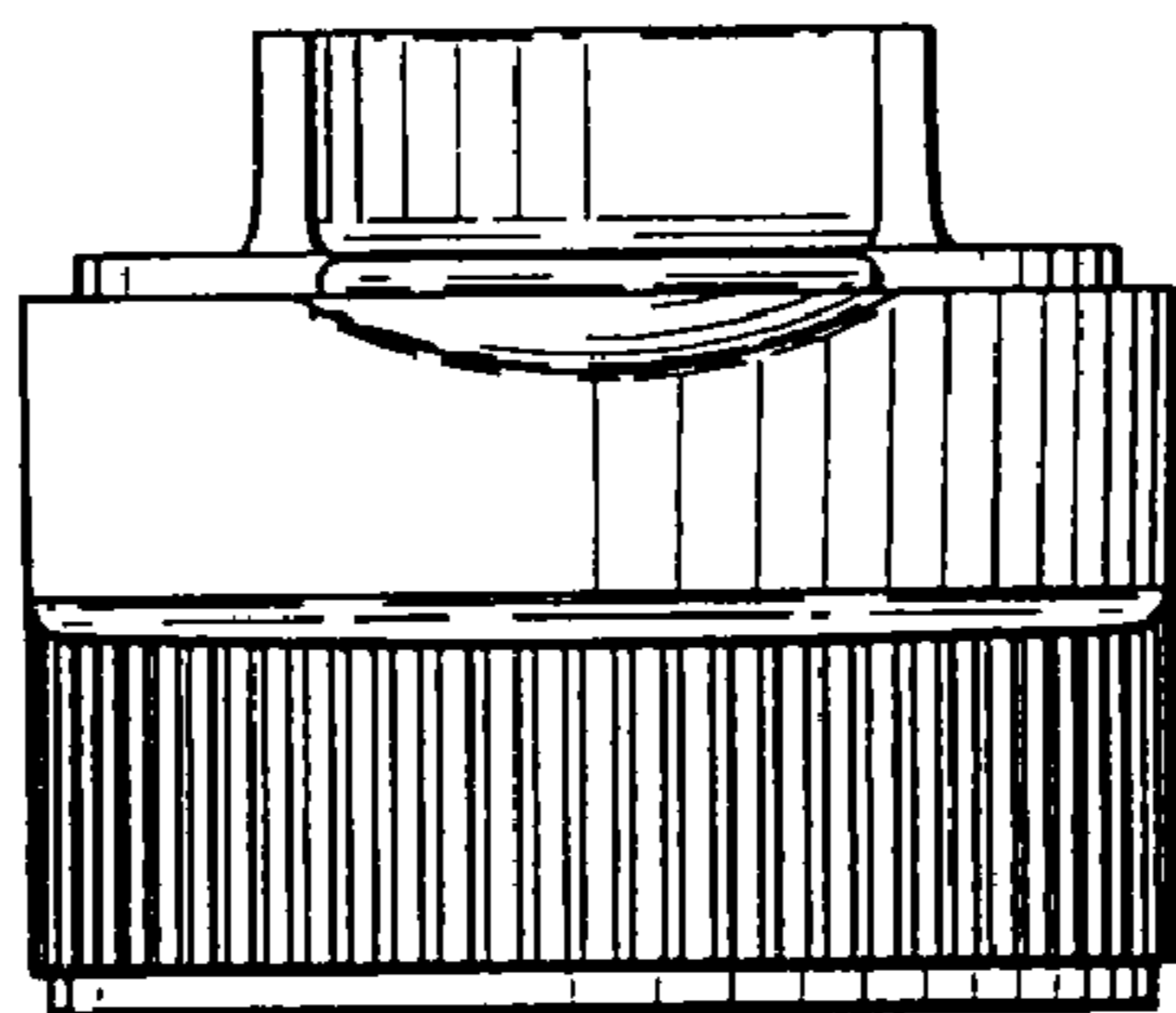

Fig. 12

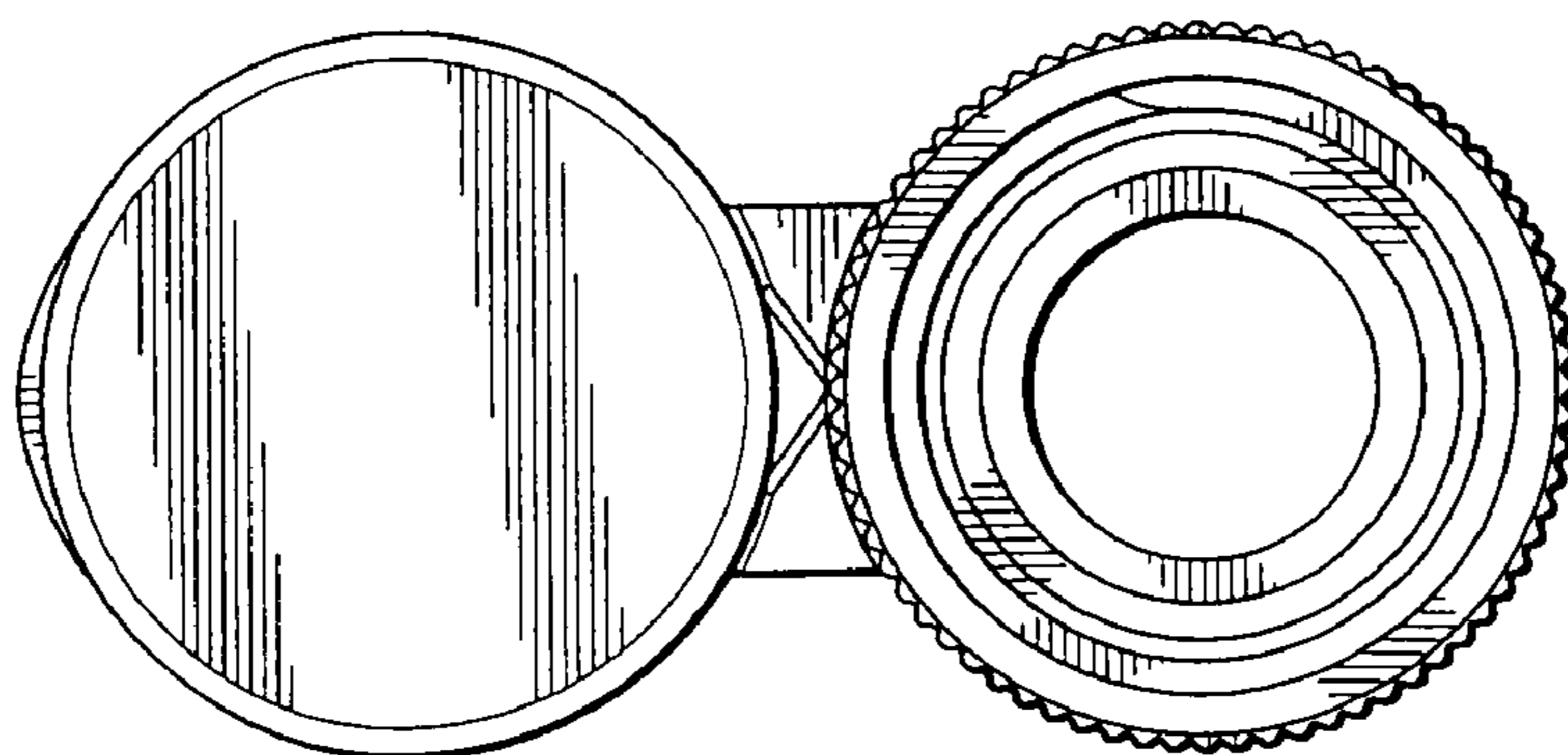

Fig. 13