



US00D585671S

(12) **United States Design Patent**
Munsterman

(10) **Patent No.:** **US D585,671 S**

(45) **Date of Patent:** **** Feb. 3, 2009**

(54) **HIGH CHAIR TRAY COVER**

7,011,363 B1 * 3/2006 Connery 297/153
7,318,380 B2 * 1/2008 Guard et al. 108/25

(76) Inventor: **Shanna Munsterman**, 800 Avenue F,
Marrero, LA (US) 70072

* cited by examiner

(**) Term: **14 Years**

Primary Examiner—Sandra Snapp
(74) *Attorney, Agent, or Firm*—Keaty Professional Law
Corporation

(21) Appl. No.: **29/291,664**

(22) Filed: **Sep. 10, 2007**

(57) **CLAIM**

(51) **LOC (9) Cl.** **06-01**

The ornamental design for a high chair tray cover, as shown
and described.

(52) **U.S. Cl.** **D6/491**

(58) **Field of Classification Search** D6/333–335,
D6/339, 491, 499–502; D12/129; D21/412,
D21/416, 419; 280/30, 31; 5/93.1, 93.2,
5/94, 98.1, 99.1, 101, 102, 655; 297/183.1,
297/183.2, 183.3, 183.4, 184.14, 184.15,
297/250.1, 255, 256.15, 256.16

DESCRIPTION

FIG. 1 is a perspective view of my design installed on a typical
high chair, which is shown in phantom lines and form no part
of the claimed design;

See application file for complete search history.

FIG. 2 is a top plan view thereof;

FIG. 3 is a bottom plan view thereof;

FIG. 4 is a front elevation view thereof;

FIG. 5 is a back elevation view thereof;

FIG. 6 is a right side view thereof; and,

FIG. 7 is a left side view thereof.

(56) **References Cited**

U.S. PATENT DOCUMENTS

D238,038 S * 12/1975 Turco D6/511
4,927,024 A * 5/1990 Lloyd 206/562
D374,125 S * 10/1996 Bernstein et al. D6/333
6,283,042 B1 * 9/2001 Wargo et al. 108/26

1 Claim, 2 Drawing Sheets

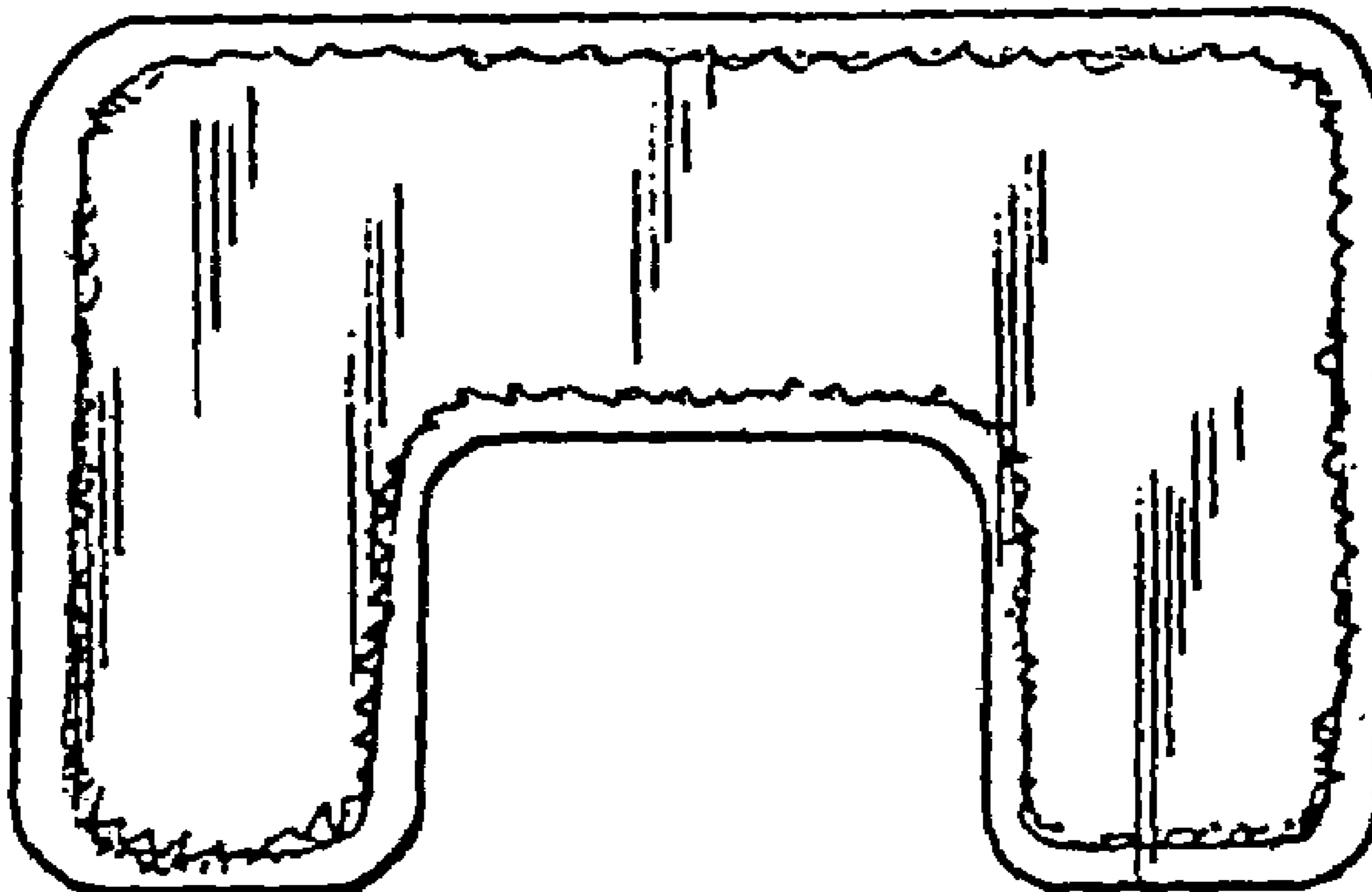

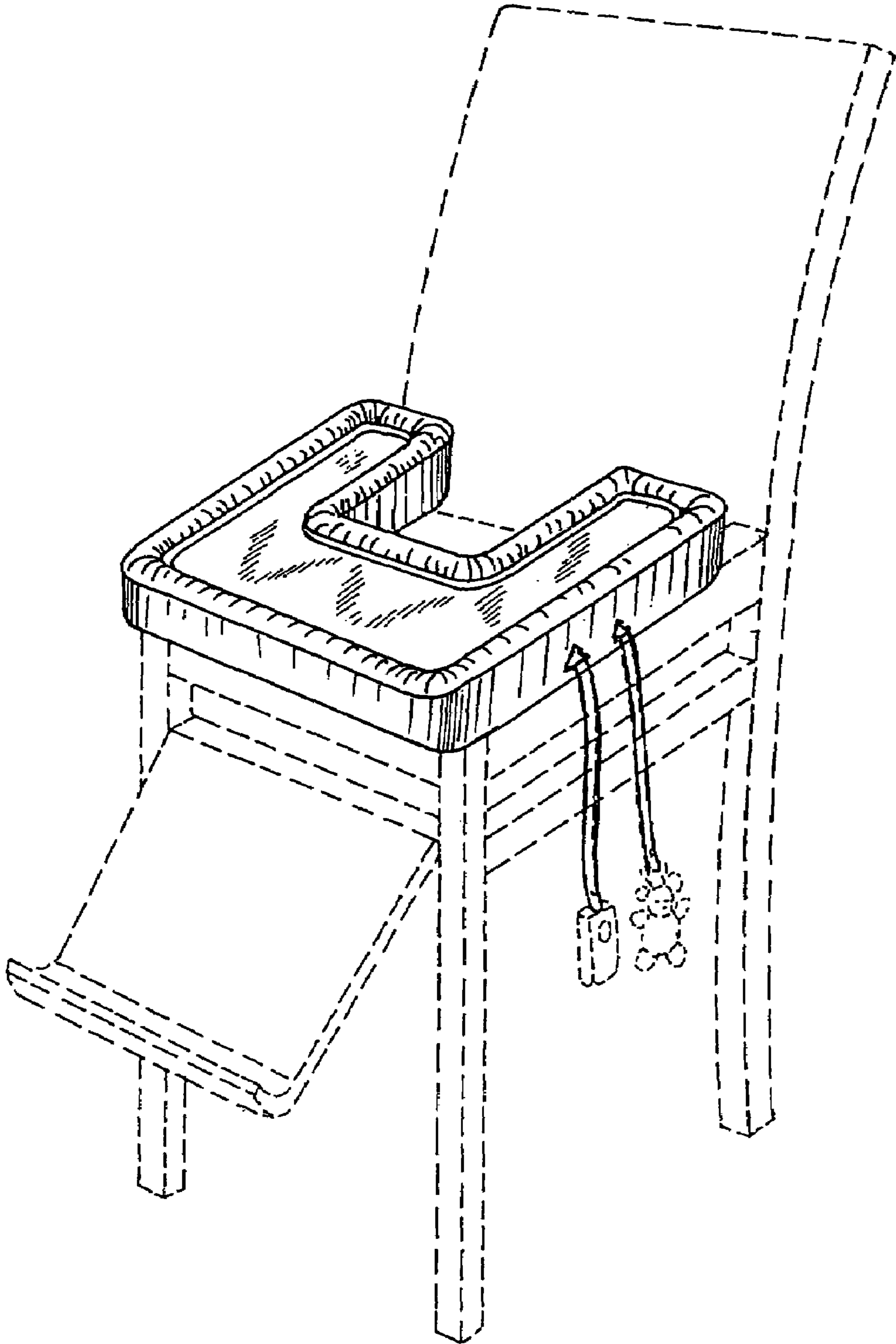

F I G . 1

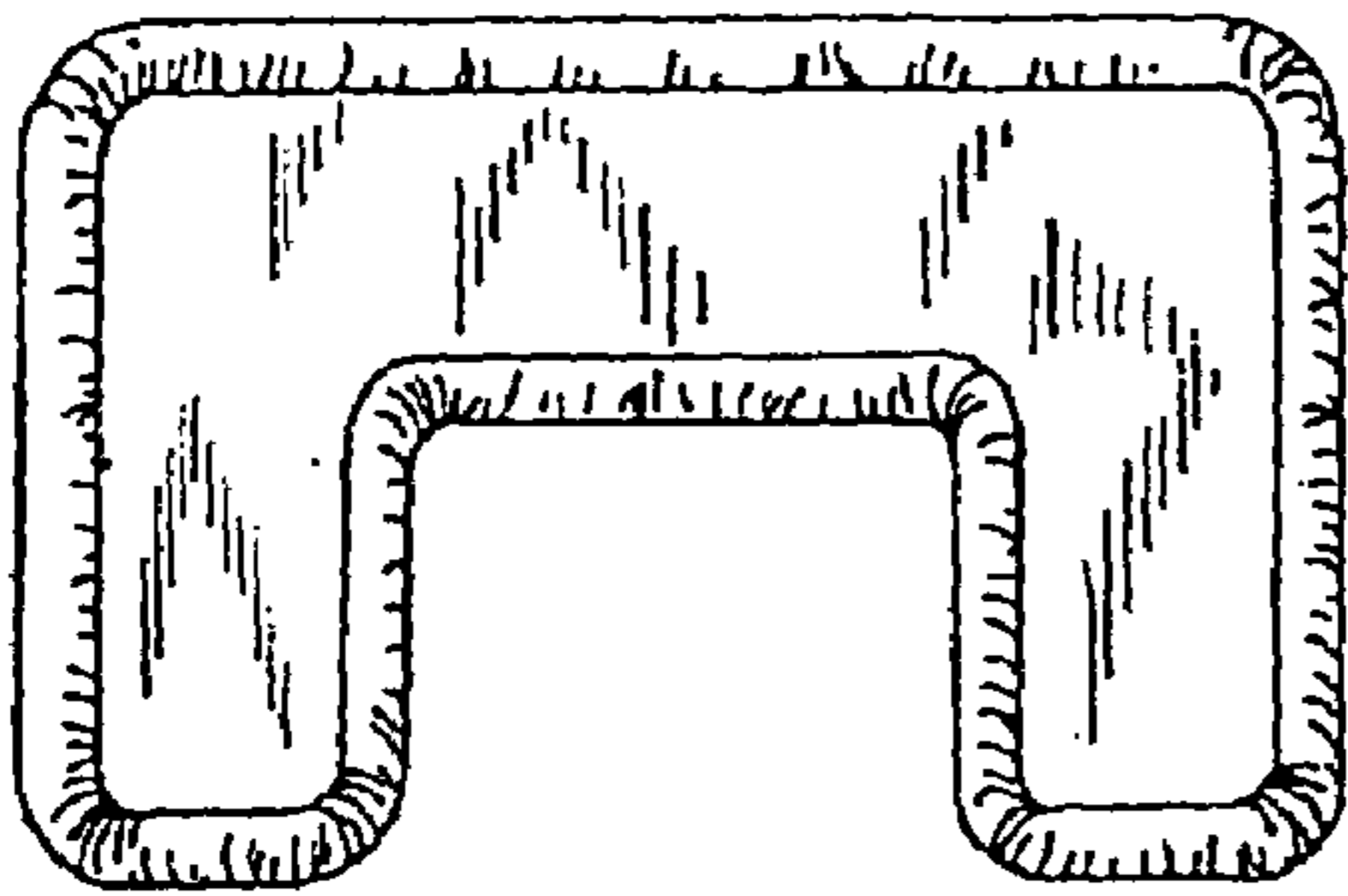

FIG. 2

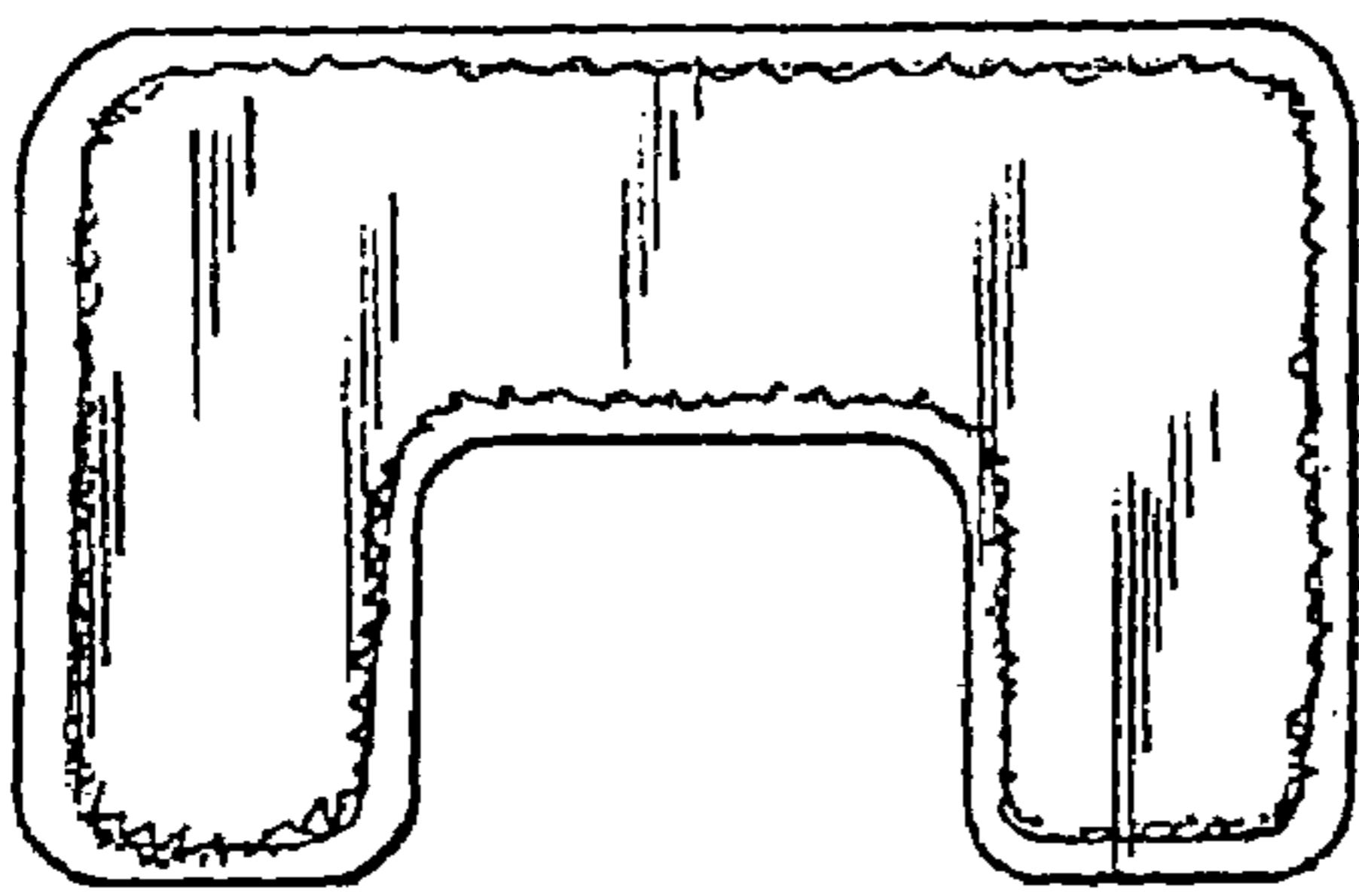

FIG. 3

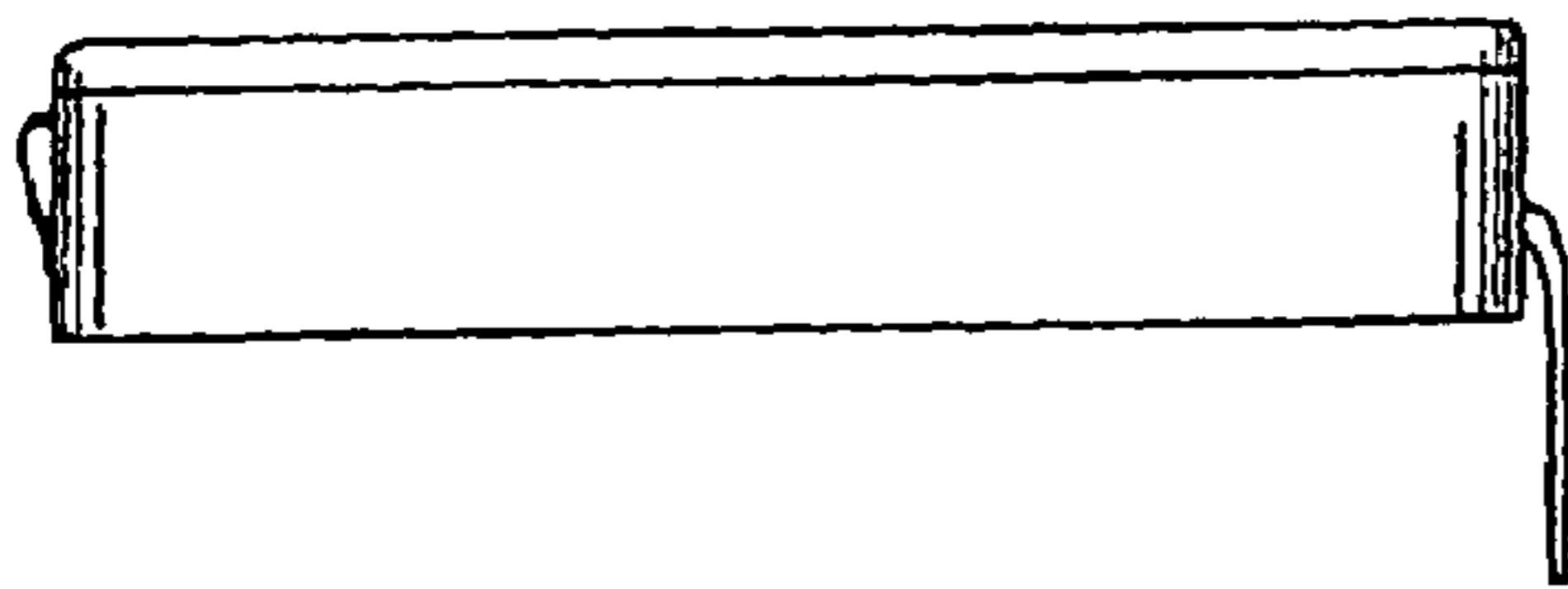

FIG. 4

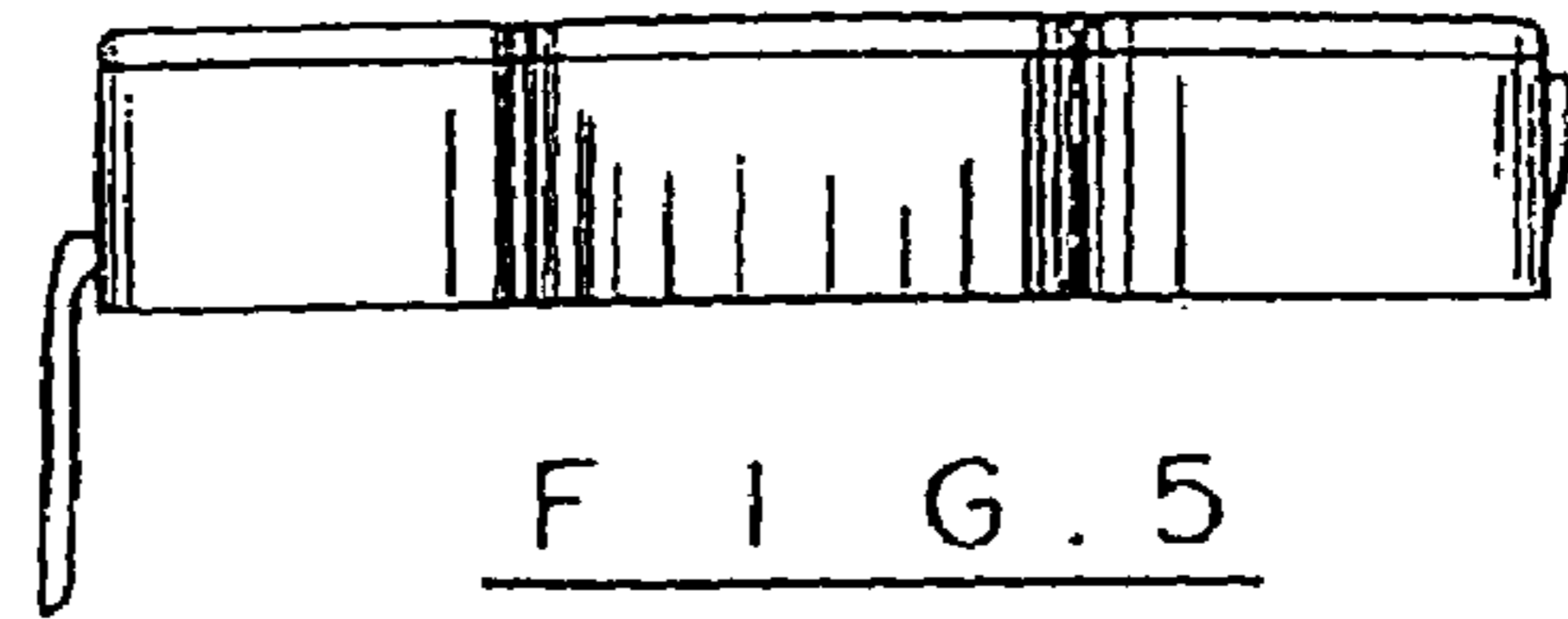

FIG. 5



FIG. 6

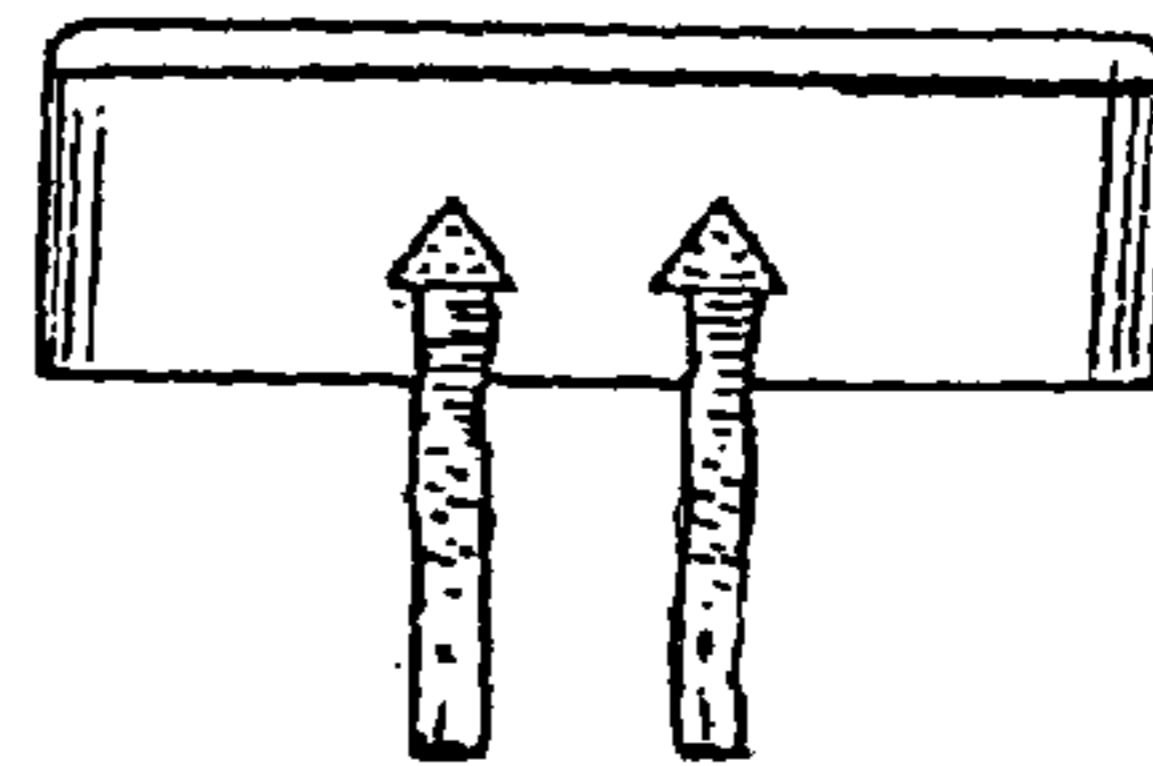

FIG. 7