



US00D585669S

(12) **United States Design Patent**
Gharabegian

(10) **Patent No.:** **US D585,669 S**

(45) **Date of Patent:** **** Feb. 3, 2009**

(54) **TABLE**

(75) **Inventor:** **Armen Sevada Gharabegian**, Glendale, CA (US)

(73) **Assignee:** **Lounge22, LLC**, Burbank, CA (US)

(**) **Term:** **14 Years**

(21) **Appl. No.:** **29/301,173**

(22) **Filed:** **Feb. 14, 2008**

(51) **LOC (9) Cl.** **06-03**

(52) **U.S. Cl.** **D6/480**

(58) **Field of Classification Search** D6/480-489,
D6/495-499, 429-431, 511; 108/150, 153.1,
108/156, 157.1, 161; 248/188, 188.1, 188.8
See application file for complete search history.

(56) **References Cited**

U.S. PATENT DOCUMENTS

- D236,402 S * 8/1975 Lubke D6/487
- D530,543 S * 10/2006 High D6/480
- D574,164 S * 8/2008 Lambert et al. D6/429

* cited by examiner

Primary Examiner—Janice E Seeger

(74) *Attorney, Agent, or Firm*—Pillsbury Winthrop Shaw Pittman LLP

(57) **CLAIM**

The ornamental design for a table, as shown and described.

DESCRIPTION

FIG. 1 is an upper left front perspective view of a table showing a new design;

FIG. 2 is a lower rear perspective view of the table showing the new design;

FIG. 3 is a top view of the table showing the new design;

FIG. 4 is a bottom view of the table showing the new design;

FIG. 5 is a front view of the table showing the new design, the back view showing the same; and,

FIG. 6 is a right side view of the table showing the new design, the left side view showing the same.

1 Claim, 3 Drawing Sheets

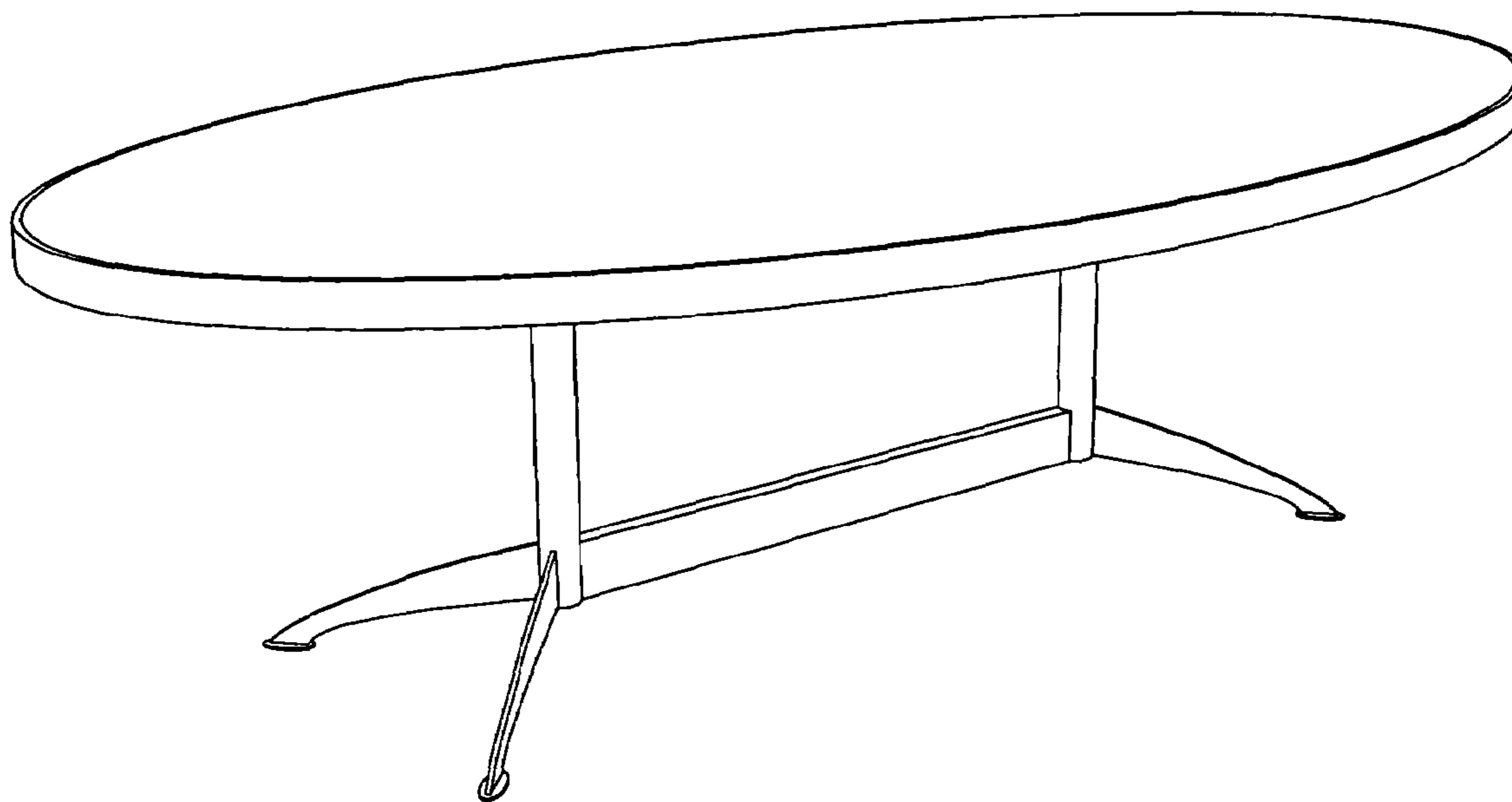

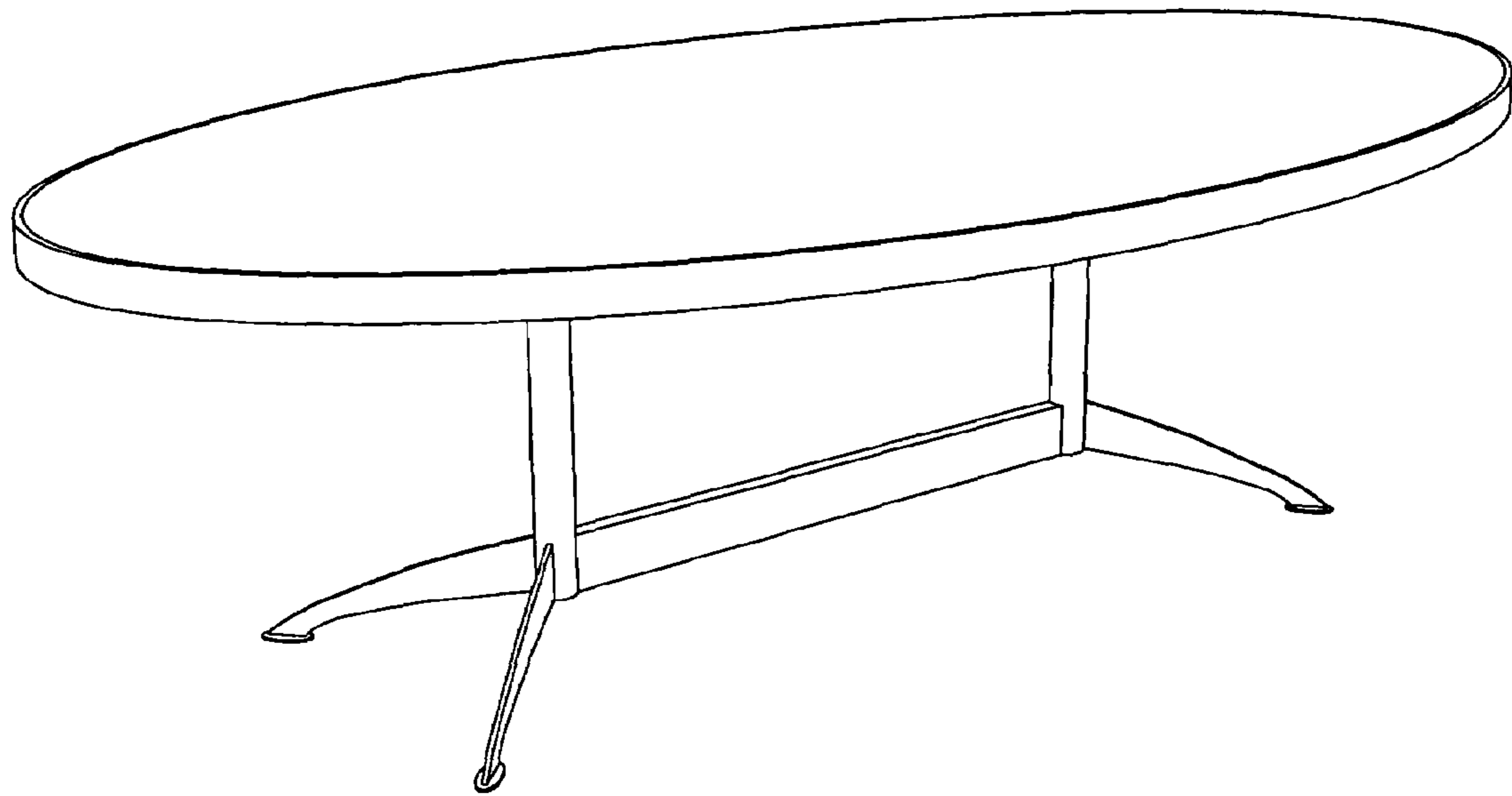

Fig. 1

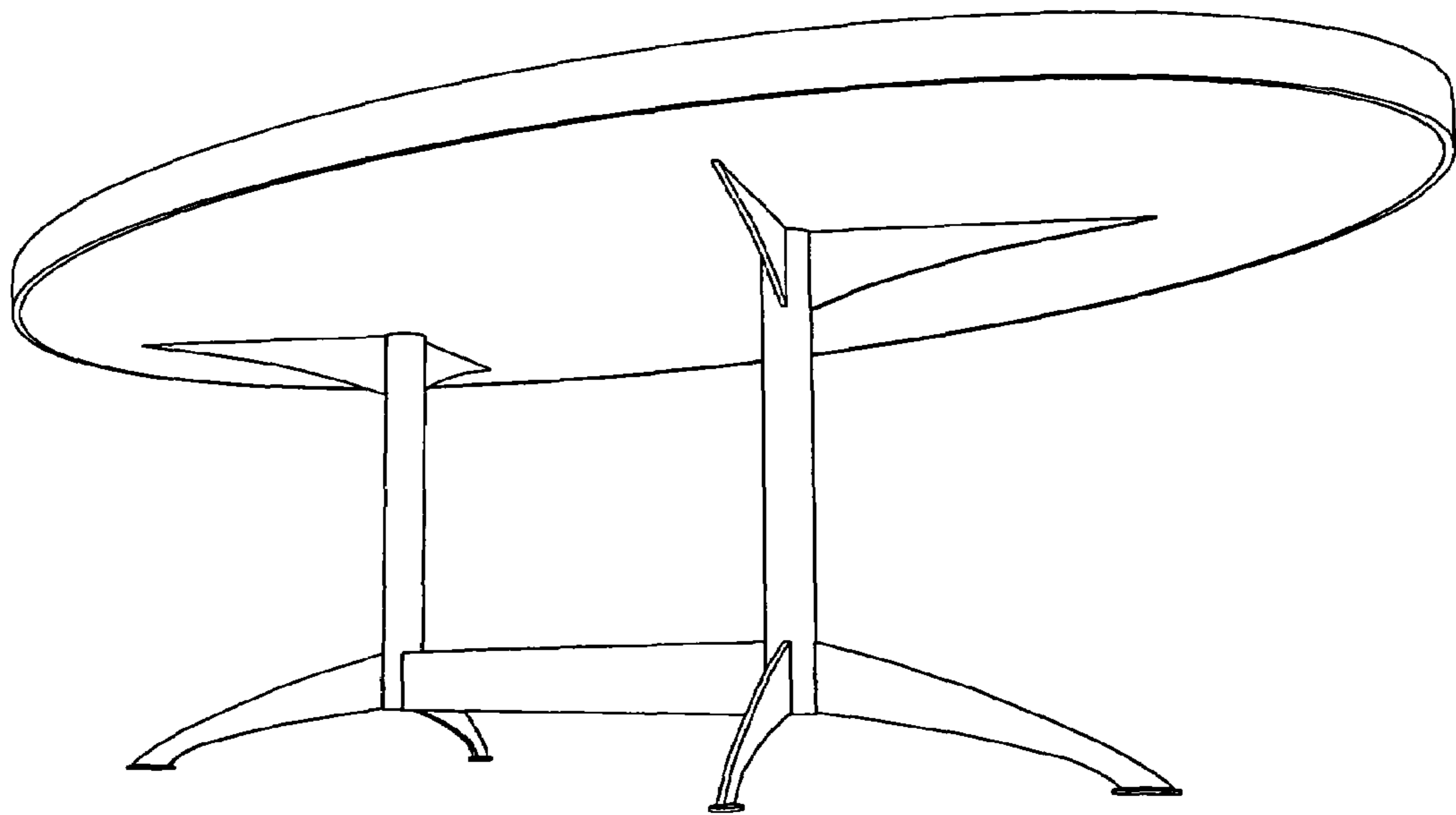

Fig. 2

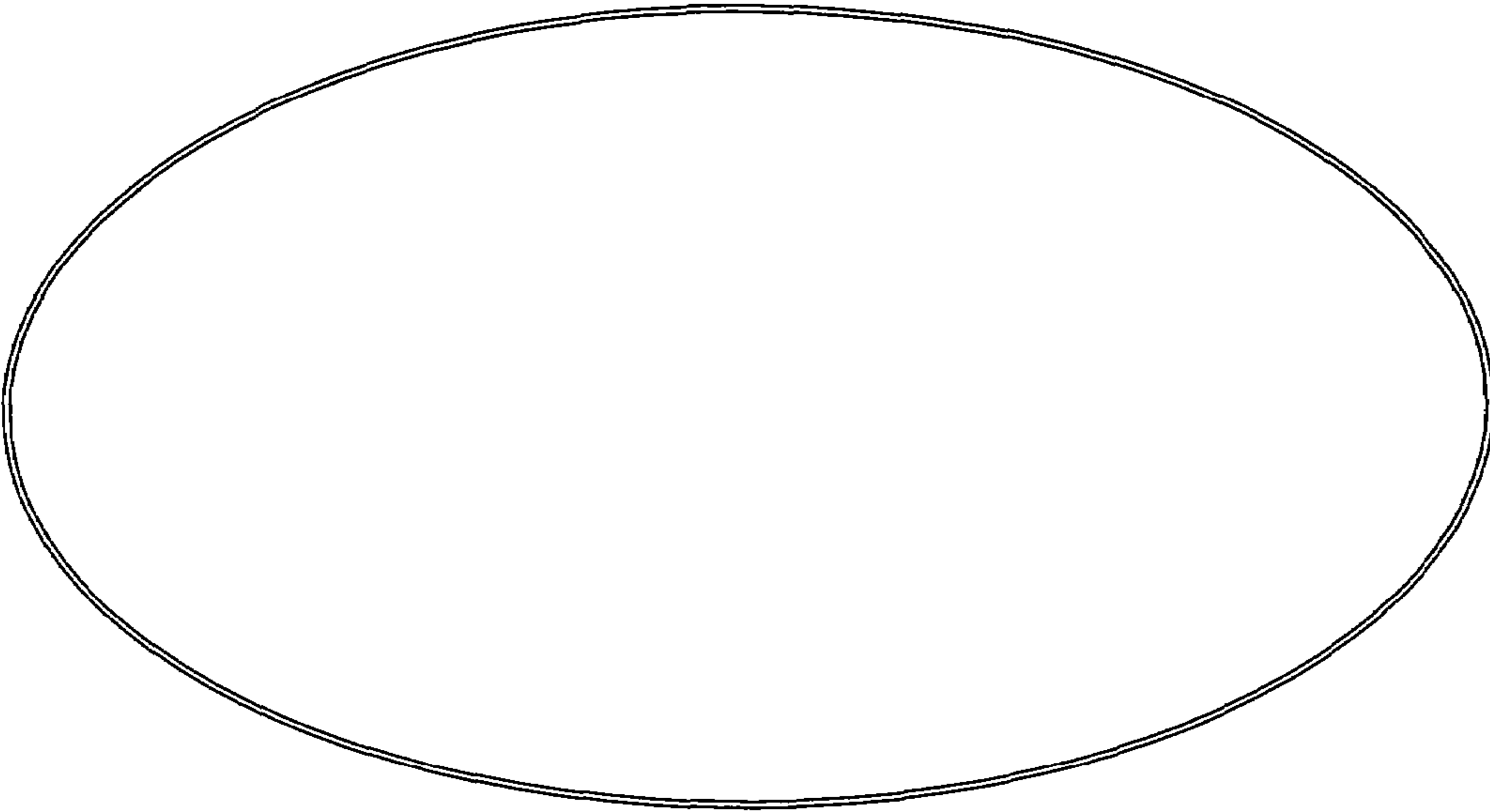

Fig. 3

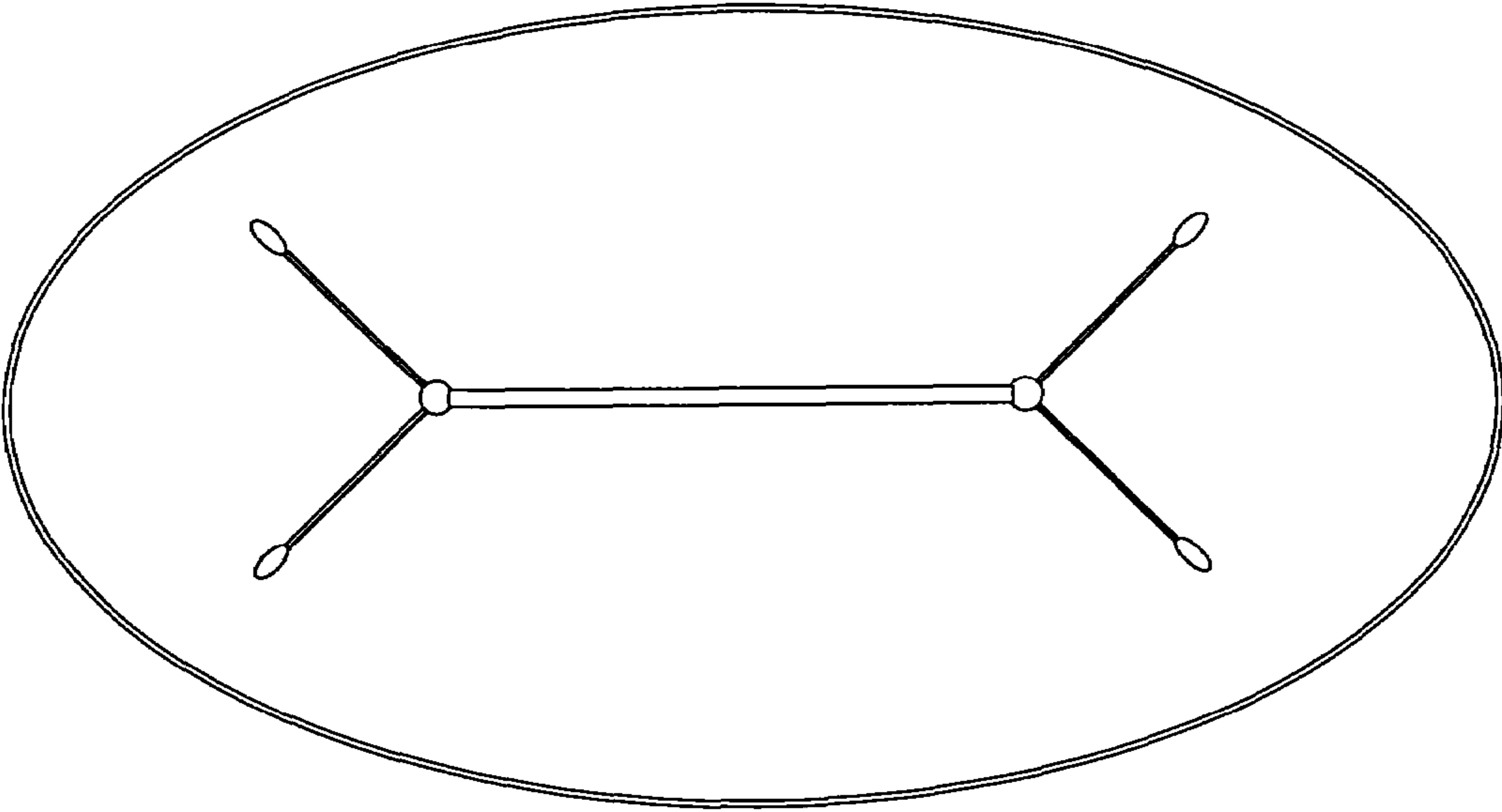

Fig. 4

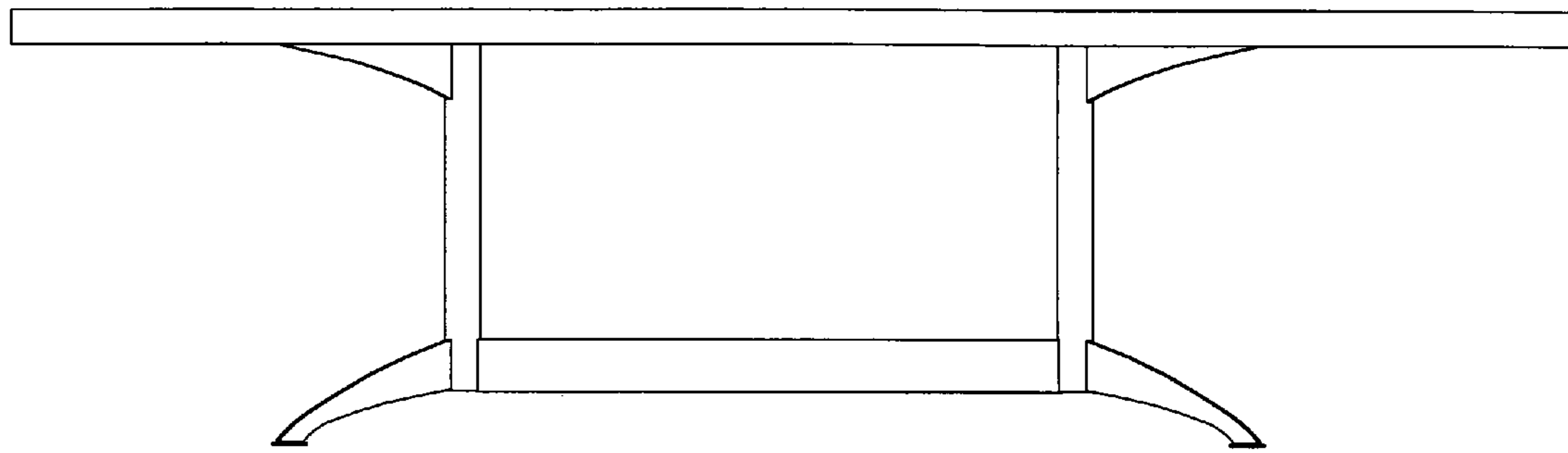

Fig. 5

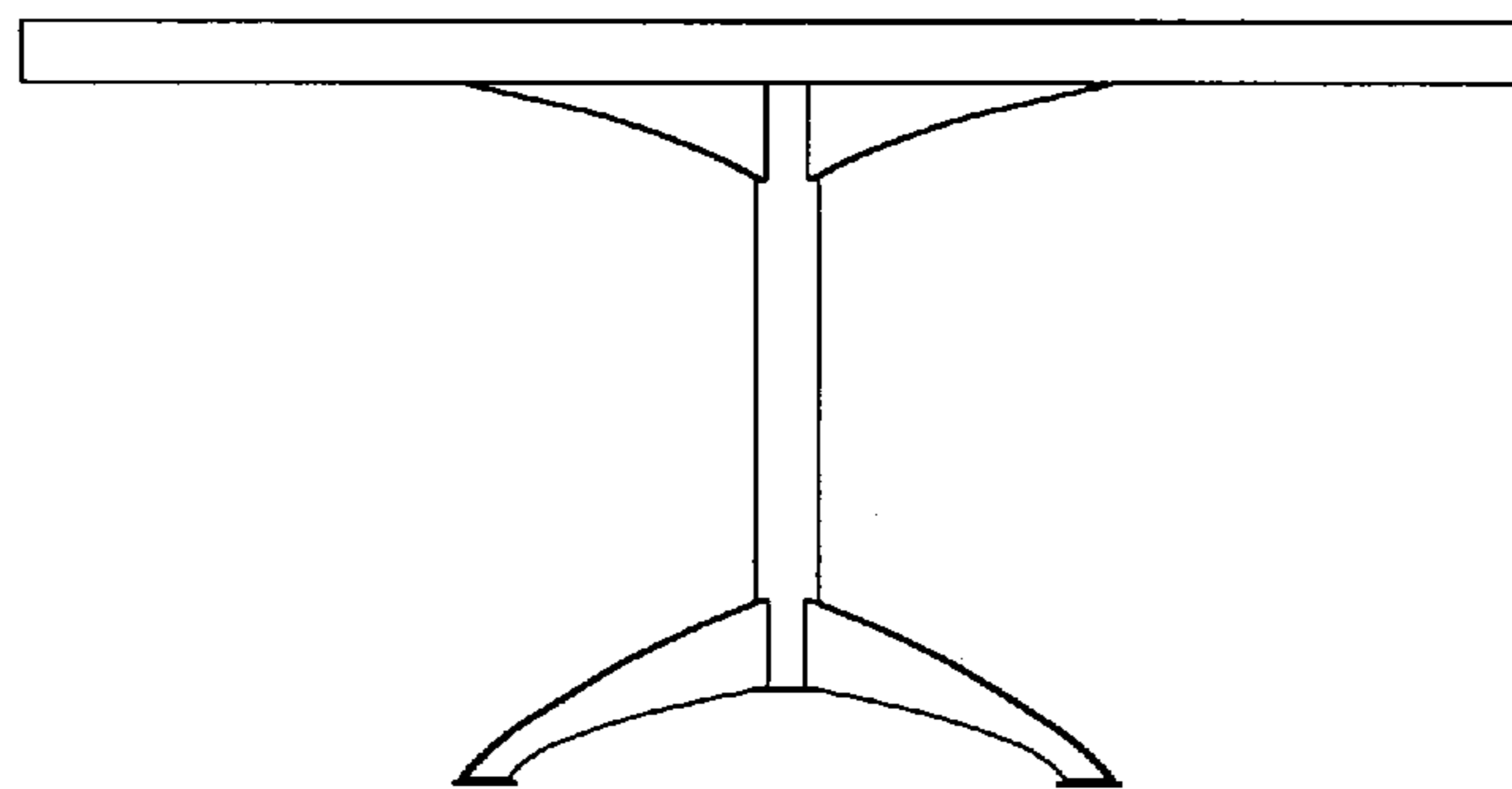

Fig. 6