



US00D585667S

(12) **United States Design Patent**
Levy et al.

(10) **Patent No.:** **US D585,667 S**

(45) **Date of Patent:** **** Feb. 3, 2009**

(54) **BRACKET**

(75) Inventors: **Gordon Levy**, Denver, CO (US); **Ming Shan**, Northglenn, CO (US)

(73) Assignee: **Navajo Manufacturing Company Inc.**, Denver, CO (US)

(**) Term: **14 Years**

(21) Appl. No.: **29/290,209**

(22) Filed: **Nov. 5, 2007**

(51) **LOC (9) Cl.** **06-04**

(52) **U.S. Cl.** **D6/467**

(58) **Field of Classification Search** D6/467,
D6/468, 570, 552, 457, 466, 469; 248/300;
D8/349, 381, 363, 354, 371, 259; D7/708,
D7/701; 211/74, 13.1, 70.6, 70.7, 70.8, 71.01,
211/60.1; D3/259; D30/133

See application file for complete search history.

(56) **References Cited**

U.S. PATENT DOCUMENTS

D75,828 S * 7/1928 Canfield D6/468
D253,802 S * 1/1980 Loud et al. D7/708
D273,647 S * 5/1984 Kandarian D6/570
D319,361 S * 8/1991 Moser D6/468
D324,301 S * 3/1992 Ackerfeldt D3/259

D364,943 S * 12/1995 Valentine et al. D30/133
D378,482 S * 3/1997 Hall et al. D6/552
5,657,883 A * 8/1997 Badia 211/70.8
D550,540 S * 9/2007 Nawrocki D8/354
D563,771 S * 3/2008 Prechtel et al. D8/354
D568,697 S * 5/2008 Allen D7/708
D575,599 S * 8/2008 Ignozzi D7/701

* cited by examiner

Primary Examiner—Caron Veynar

Assistant Examiner—Sydney R Buffalow

(74) *Attorney, Agent, or Firm*—Jacobson Holman PLLC

(57) **CLAIM**

The ornamental design for a bracket, as shown and described.

DESCRIPTION

FIG. 1 is a perspective view showing my new design for a bracket,

FIG. 2 is a top view thereof,

FIG. 3 is a bottom view thereof,

FIG. 4 is a front view thereof,

FIG. 5 is a rear view thereof,

FIG. 6 is a right side view thereof; and,

FIG. 7 is a left side view thereof.

1 Claim, 4 Drawing Sheets

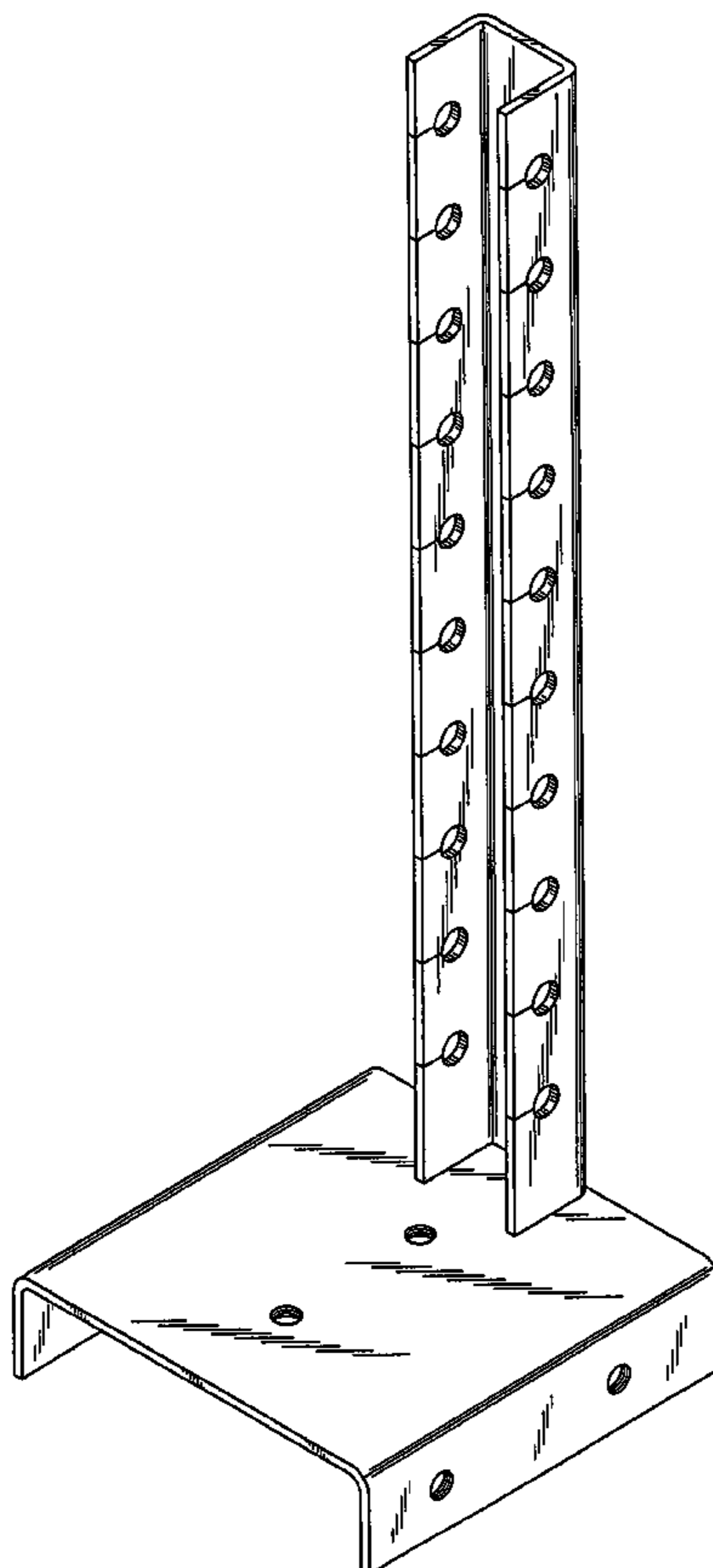

FIG. 1

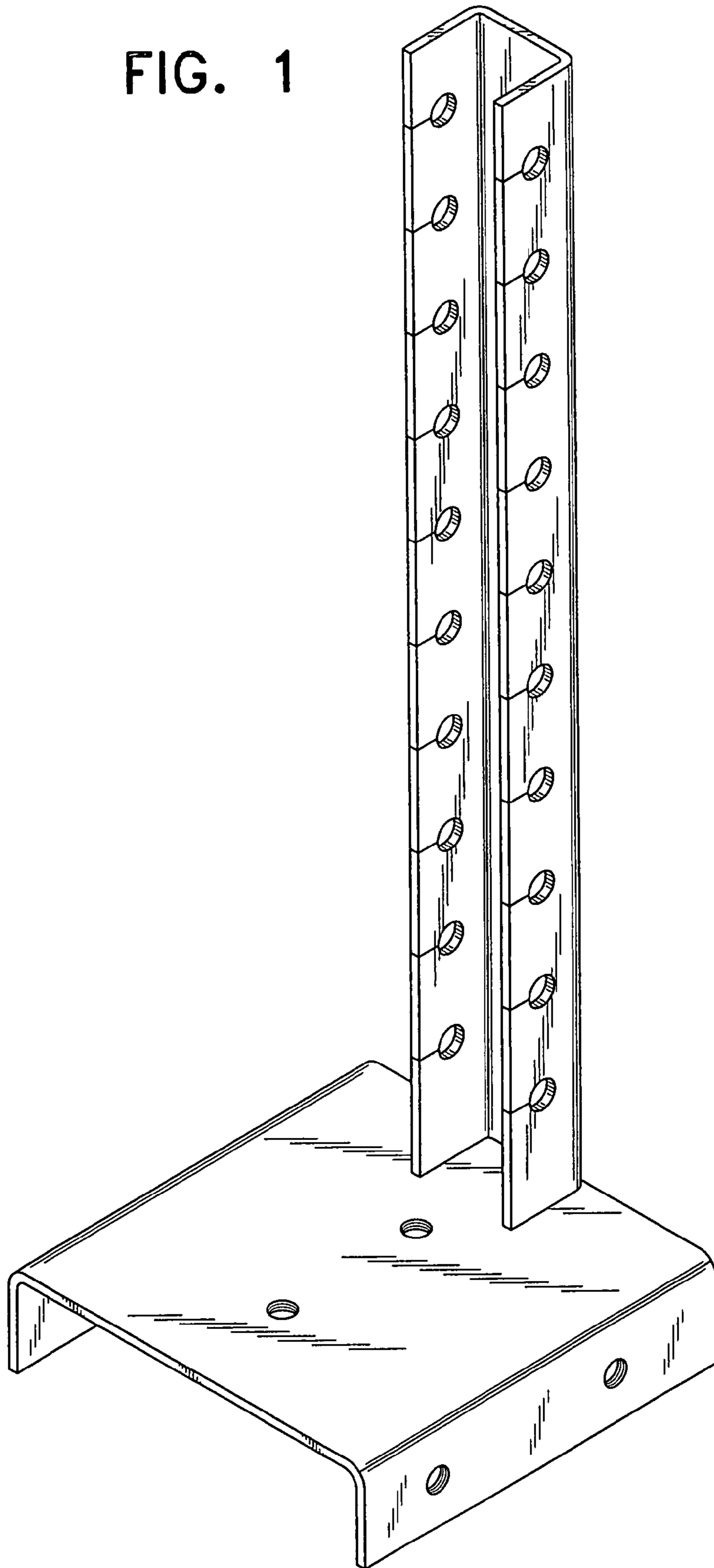

FIG. 2

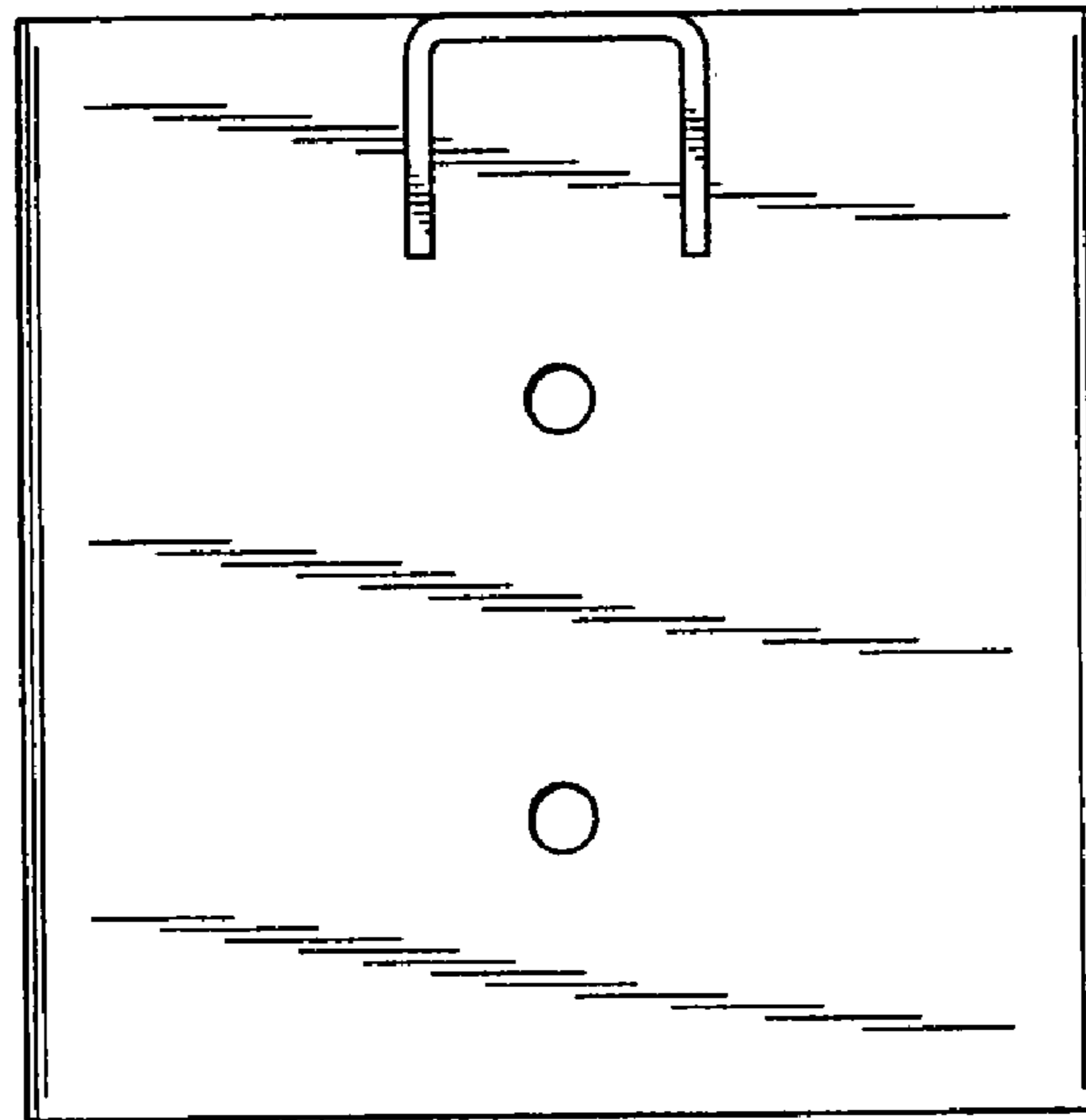

FIG. 3

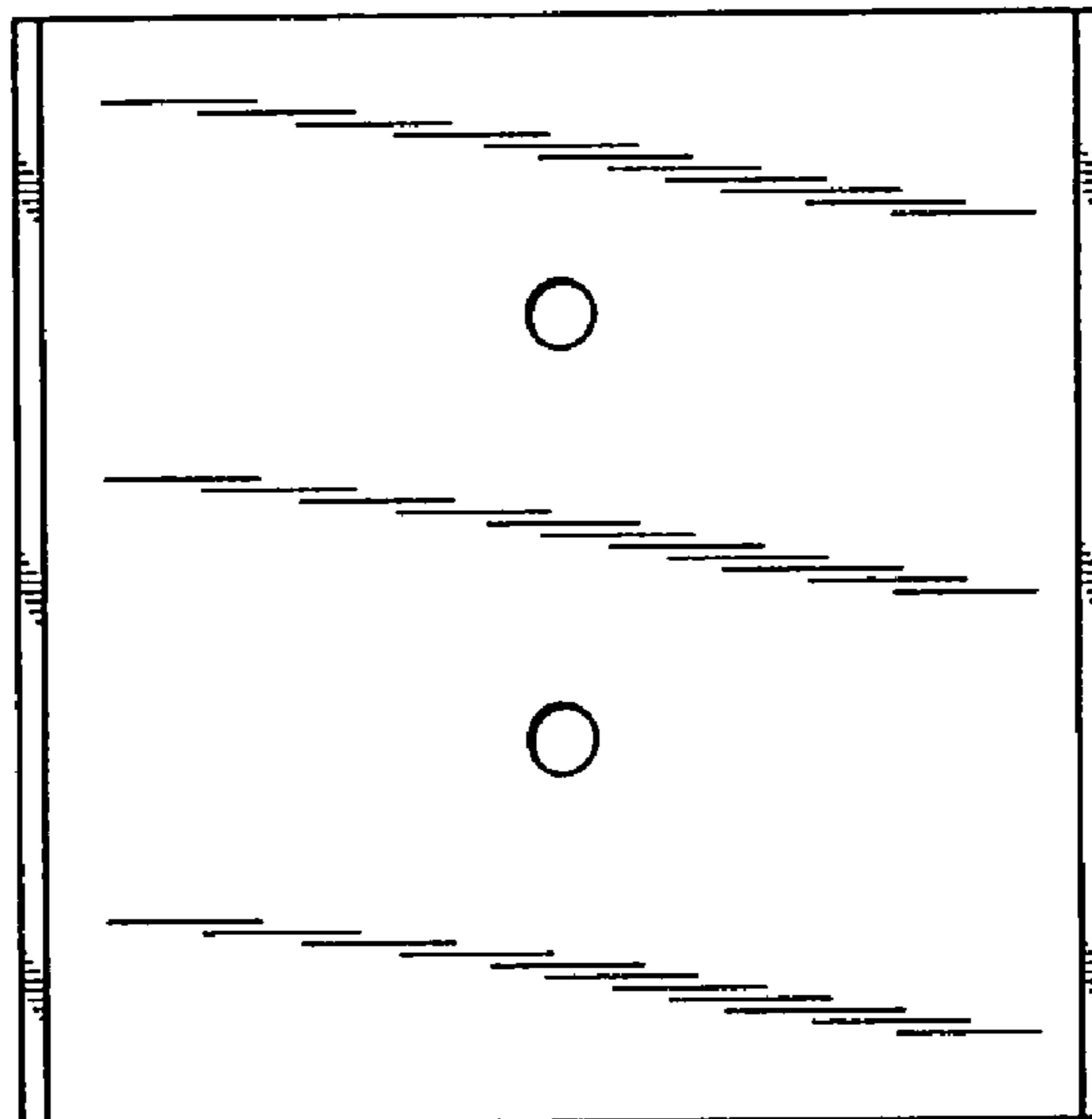

FIG. 4

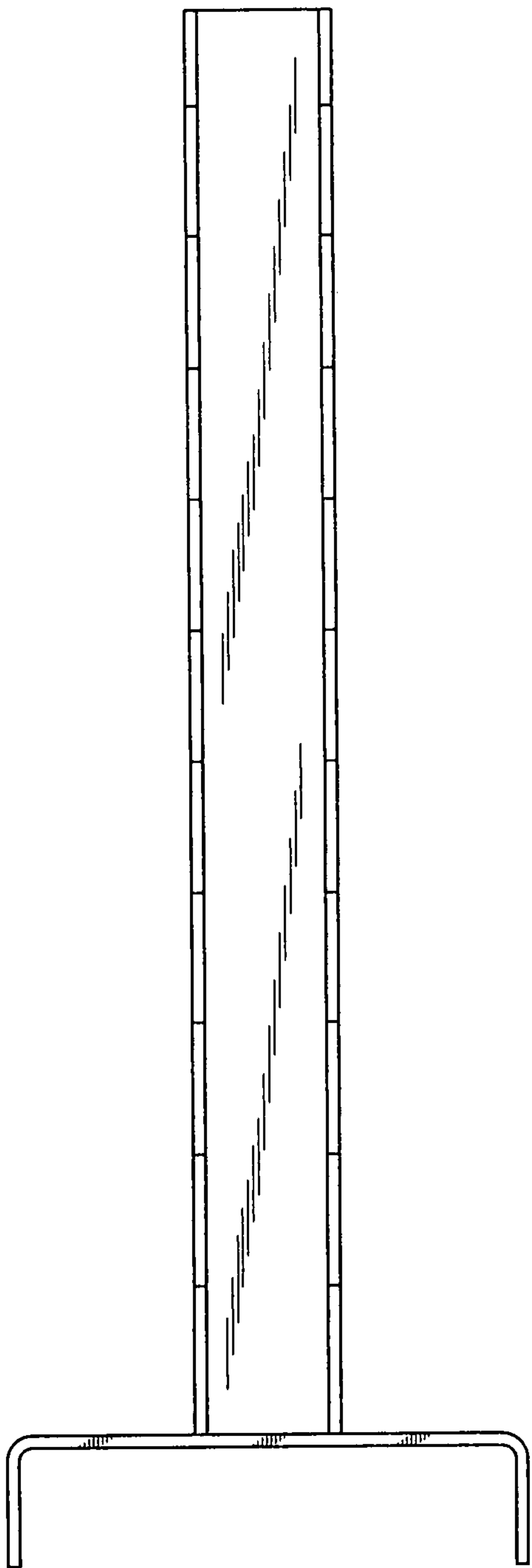

FIG. 5

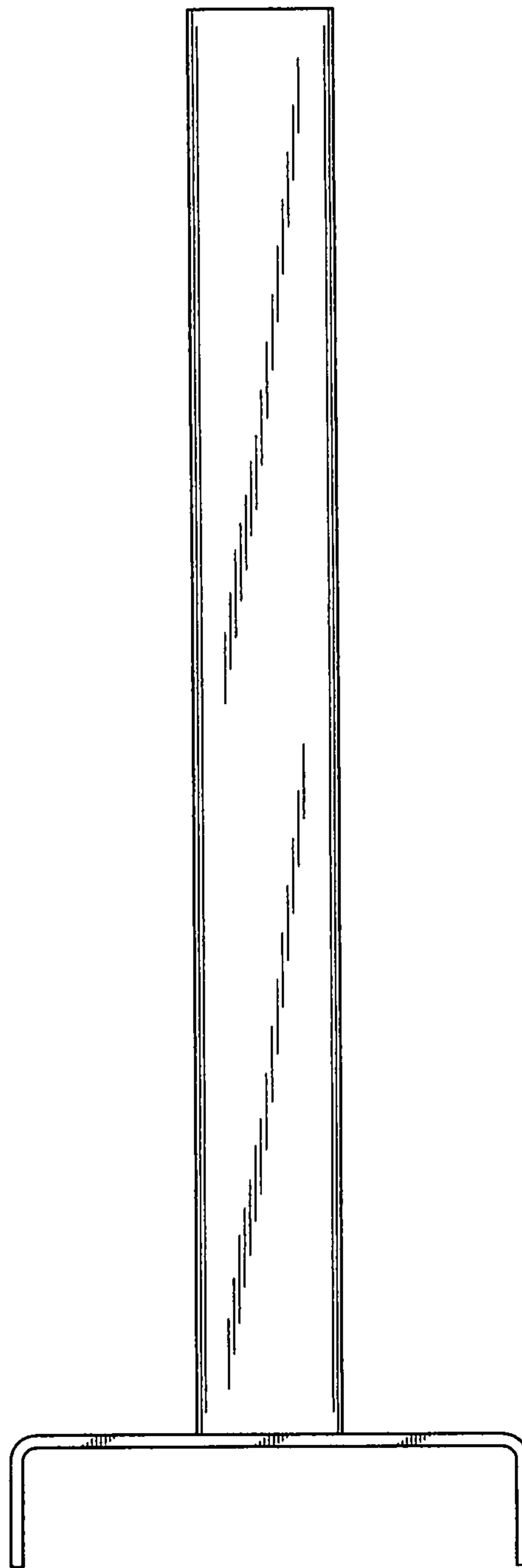

FIG. 6

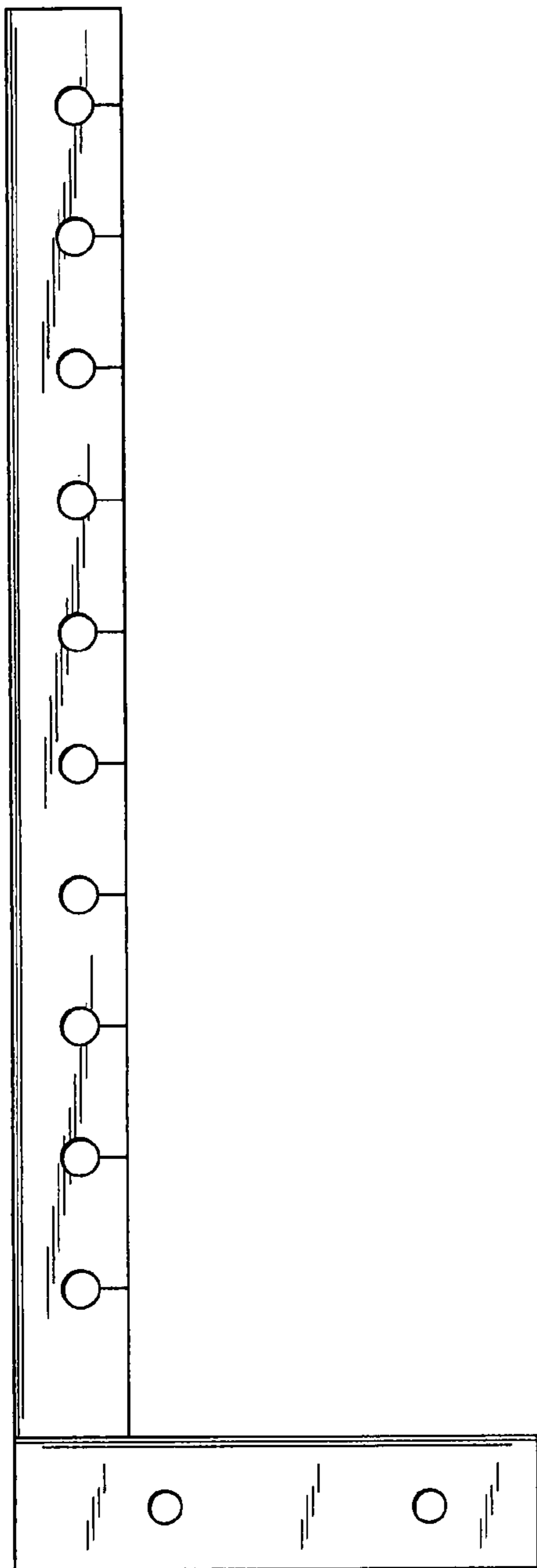

FIG. 7

