



US00D585646S

(12) **United States Design Patent**  
**Crain et al.**

(10) **Patent No.:** **US D585,646 S**  
(45) **Date of Patent:** **\*\* Feb. 3, 2009**

(54) **CARRYING BAG FOR A SURVEY ROD**

(75) Inventors: **Stephen B. Crain**, Cape Girardeau, MO (US); **Lindsey Marie Davis**, Cape Girardeau, MO (US)

(73) Assignee: **Crain Enterprises, Inc.**, Mound City, IL (US)

(\*\*) Term: **14 Years**

(21) Appl. No.: **29/282,530**

(22) Filed: **Jul. 23, 2007**

(51) **LOC (9) Cl.** ..... **03-01**

(52) **U.S. Cl.** ..... **D3/269**

(58) **Field of Classification Search** ..... D3/254,  
D3/260, 262, 273, 276, 291, 221; 206/315.1,  
206/443; 190/100, 110, 111, 119, 120, 121;  
473/1, 2, 3

See application file for complete search history.

(56) **References Cited**

**U.S. PATENT DOCUMENTS**

- D293,044 S \* 12/1987 Johnson ..... D3/300
- 4,860,935 A \* 8/1989 Pavlinsky ..... 224/615
- 5,553,708 A \* 9/1996 Lawrence et al. .... 206/419
- D392,801 S \* 3/1998 Hields et al. .... D3/261
- 5,829,591 A \* 11/1998 Lyons ..... 206/373
- D423,212 S 4/2000 Sakurai
- D437,680 S \* 2/2001 Gobel ..... D3/11
- D442,367 S \* 5/2001 Terrell ..... D3/260
- 6,513,692 B1 \* 2/2003 Forgosh et al. .... 224/575

- D479,398 S \* 9/2003 Sanderson ..... D3/254
- 6,773,062 B2 8/2004 Illulian
- D505,260 S 5/2005 Gruetzmacher
- D512,559 S 12/2005 Silverman
- 2007/0017835 A1 1/2007 Miller, Jr.

\* cited by examiner

*Primary Examiner*—Raphael Barkai

*Assistant Examiner*—Randall H Gholson

(74) *Attorney, Agent, or Firm*—Senniger Powers LLP

(57) **CLAIM**

The ornamental design for a carrying bag for a survey rod, as shown and described.

**DESCRIPTION**

FIG. 1 is a perspective of a carrying bag for a survey rod;

FIG. 2 is a right side elevational view thereof;

FIG. 3 is a left side elevational view thereof;

FIG. 4 is a top plan view thereof;

FIG. 5 is a bottom plan view thereof;

FIG. 6 is a rear end view thereof;

FIG. 7 is a front end view thereof;

FIG. 8 is an enlarged fragmentary perspective of a portion of the carrying bag indicated in FIG. 1 showing a cap in a closed position; and,

FIG. 9 is a perspective similar to FIG. 8 but showing the cap in an opened position.

**1 Claim, 8 Drawing Sheets**

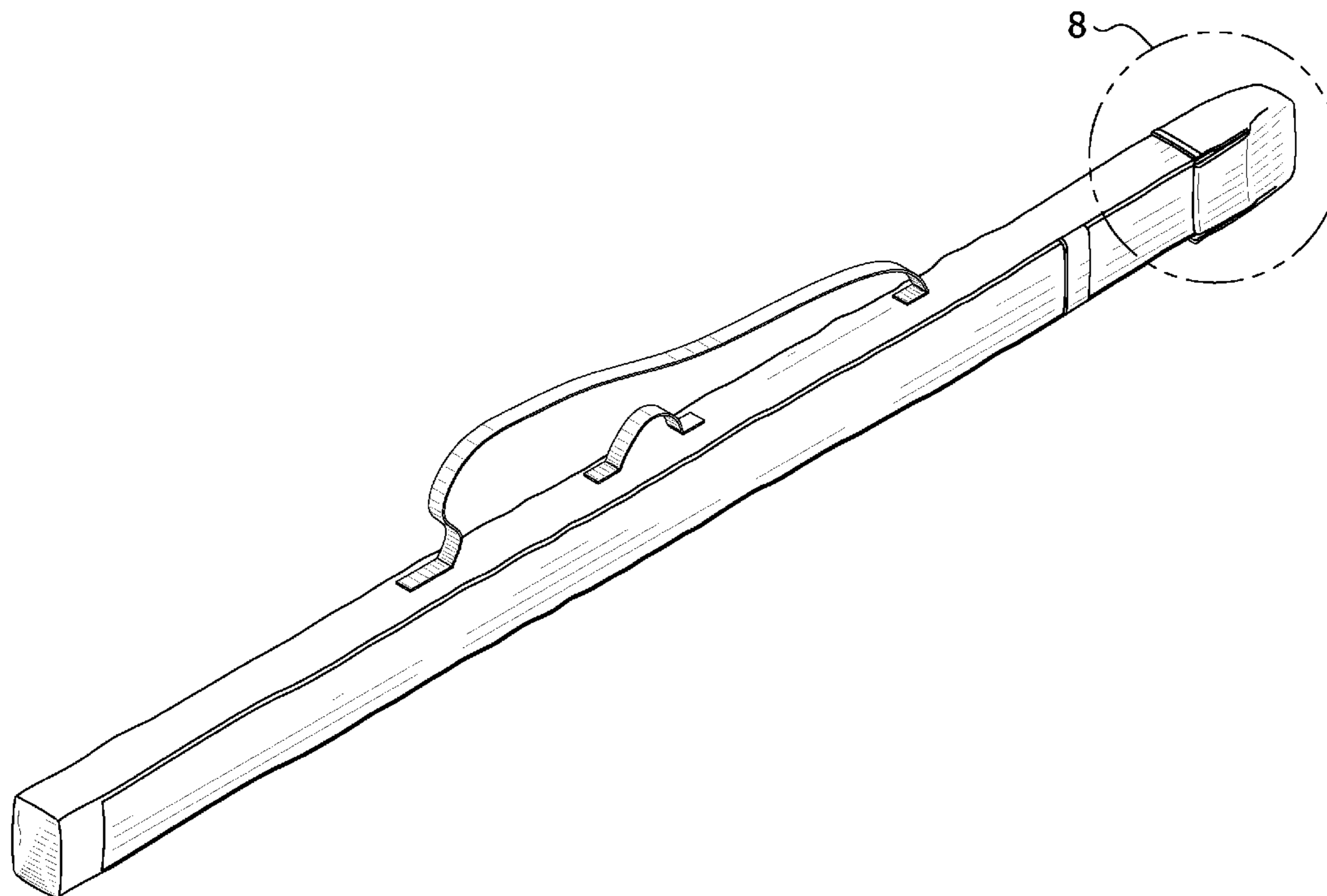

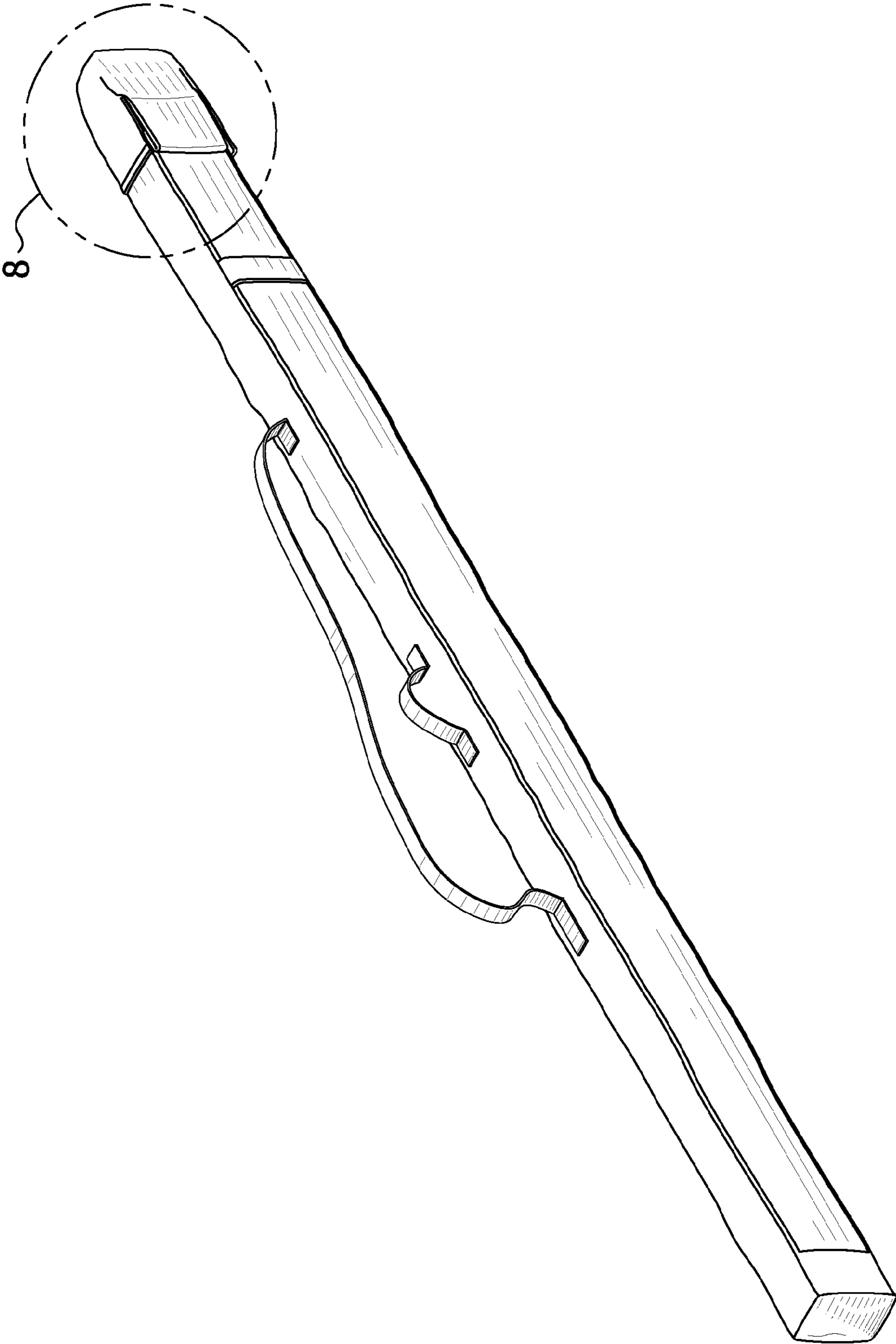

FIG. 1

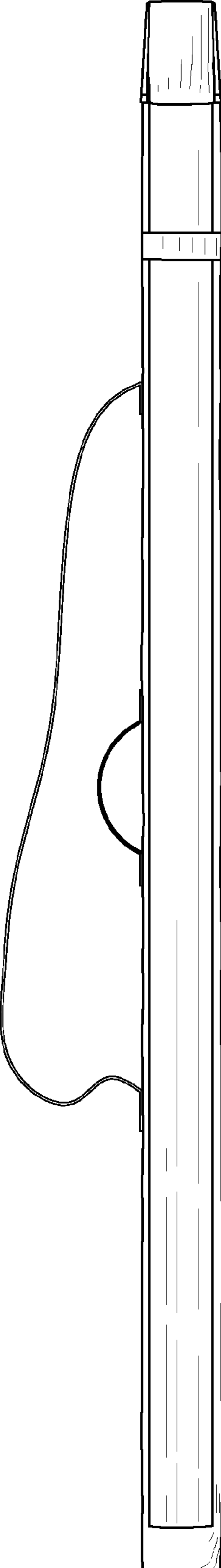

FIG. 2

FIG. 3

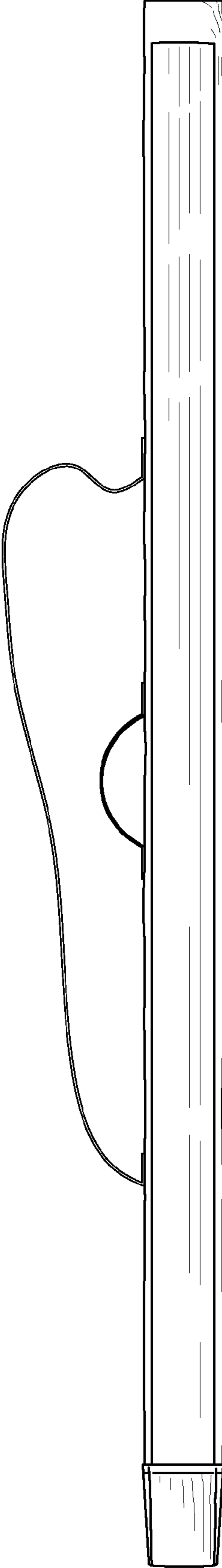

FIG. 4



FIG. 5

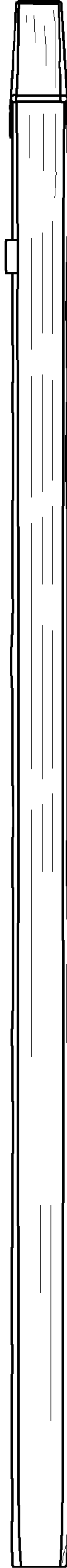

FIG. 6

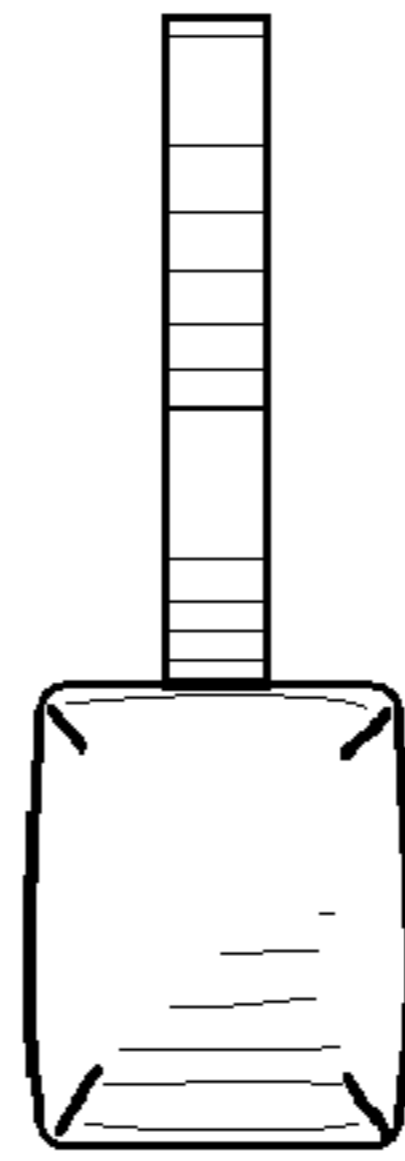

FIG. 7

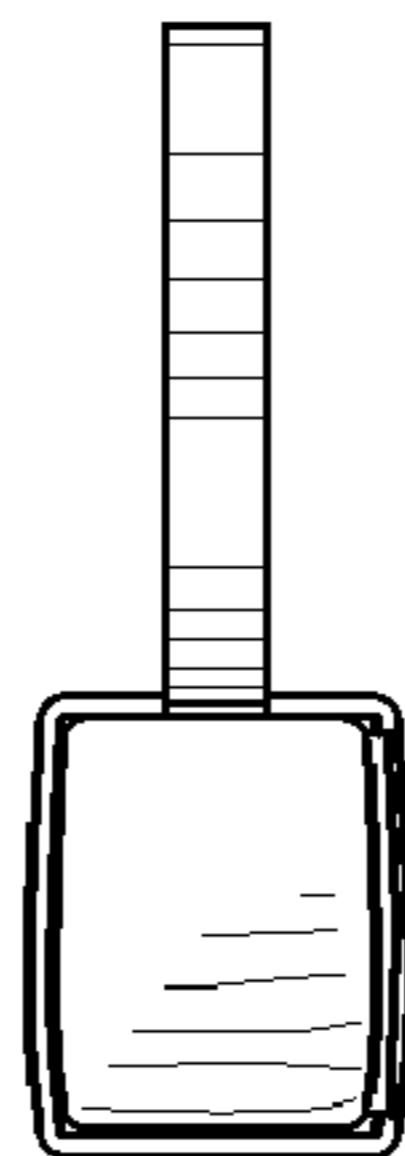

FIG. 8

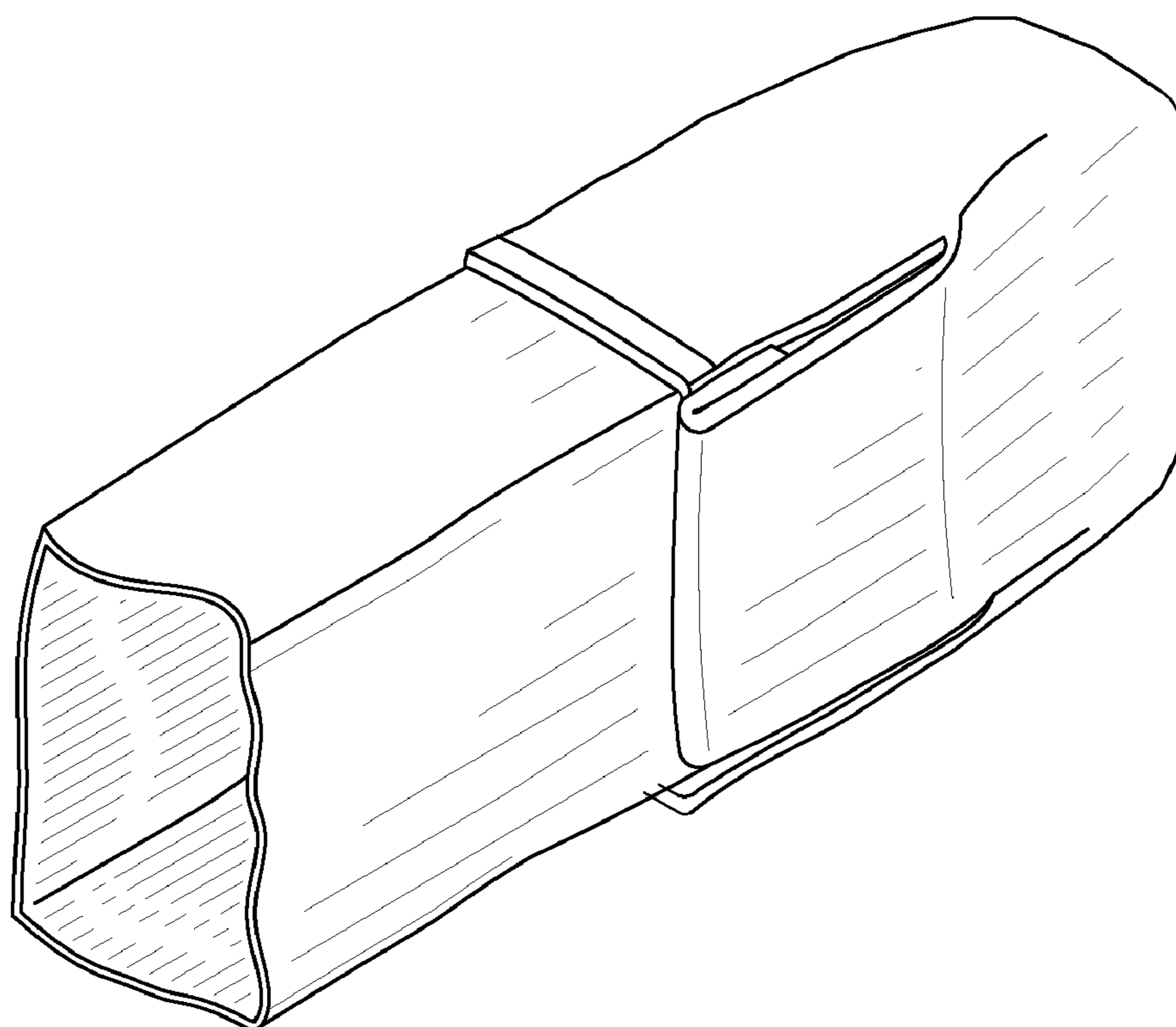



FIG. 9

